



Collection of Methods for Biogas

Methods to determine parameters for analysis purposes and parameters that describe processes in the biogas sector



**Biomass
energy use**



Biomass energy use

Series "Biomass energy use"
VOLUME 7

Collection of Methods for Biogas

Methods to determine parameters for analysis purposes and
parameters that describe processes in the biogas sector

Edited by Jan Liebetrau, Diana Pfeiffer

2nd Volume 2020

Supported by



Federal Ministry
for Economic Affairs
and Energy

on the basis of a decision
by the German Bundestag

Project management



Projektträger Jülich
Forschungszentrum Jülich

Service & support



Editorial notes

Editors

Jan Liebetrau, Diana Pfeiffer
DBFZ Deutsches Biomasseforschungszentrum
gemeinnützige GmbH
Torgauer Straße 116
D-04347 Leipzig
Tel.: +49 (0)341 2434-554
E-mail: diana.pfeiffer@dbfz.de
www.energetische-biomassenutzung.de

Scientific coordination

Jan Liebetrau
Rytec AG
(ehemals DBFZ Deutsches
Biomasseforschungszentrum
gemeinnützige GmbH)

Layout/Typesetting

Steffen Kronberg, Angela Gröber,
Joshua Röbisch, Diana Pfeiffer

Photos

Title: DBFZ, DBFZ, DBFZ, Susanne Beeck/pixelio
Back page: A. Gröber/DBFZ

Funding

Created with financial assets of the Federal
Ministry for Economic Affairs and Energy
Berlin (BMWi)

ISBN 978-3-946629-47-4
ISSN (online): 2698-9190

The presentation of the results with corresponding concepts, conclusions and expert recommendations is the sole responsibility of the authors. This also includes safeguarding any authors' third party rights. Therefore, any questions, complaints, legal claims, etc. may only be dealt with by the authors. The opinions, assessments or suggestions listed do not reflect the publisher's opinion.

Leipzig, 2nd Volume 2020

All rights reserved.

© DBFZ 2020

(Version: October 2020)

Table of content

4	Editorial notes	
11	Table of abbreviations and symbols	
26	1 Introduction	
29	2 Definitions	
38	3 Methods for the determination of fundamental parameters	
38	3.1 Sampling of manure (Suitability for biogas production)	NEW
	Walter Stinner, Velina Denysenko, DBFZ	
50	3.2 Determination of total solids (dry matter) and volatile solids (organic dry matter)	
	Katrin Strach, DBFZ	
52	3.3 Total solids content correction according to WEISSBACH & STRUBELT	
	Britt Schumacher, DBFZ	
57	3.4 Determination of the VOA value (according to Kapp) and of the VOA/ buffer capacity value (in accordance with FAL)	
	Katrin Strach, Michael-Dittrich Zechendorf, DBFZ	
60	3.5 Determination of the ammonia nitrogen content	
	Katrin Strach, DBFZ	
61	3.6 Prediction of process failures by determining the early warning indicators A/elCon, EWI-VFA/Ca and EWI-P/Ca	NEW
	Patrick Schröder ¹ , Anne Kleyböcker ² , Hilke Würdemann ^{1,3}	
	¹ Hochschule Merseburg University of Applied Sciences	
	² Kompetenzzentrum Wasser Berlin gGmbH	
	³ Helmholtz Centre Potsdam German Research Centre for Geosciences - GFZ	
64	4 Methods for the determination of chemical parameters	
64	4.1 Determination of aliphatic, organic acids and benzaldehyde with headspace GC	
	Martin Apelt, DBFZ	
69	4.2 Determination of organic acids	
	Lucie Moeller, UFZ; Kati Görsch, DBFZ; Dietmar Ramhold, ISF Schaubmann Forschung mbH; Erich Kielhorn, TU Berlin	

72	4.3	<i>Determination of aldehydes, alcohols, ketones, volatile fatty acids</i> Erich Kielhorn, Peter Neubauer, Stefan Junne, TU Berlin
75	4.4	<i>Examination of samples of solids (substrates) and digestates with HPLC for aliphatic and aromatic acids, alcohols and aldehydes</i> Martin Apelt, DBFZ
81	4.5	<i>Determination of sugars and glucose degradation products</i> Jana Mühlenberg, DBFZ
86	4.6	<i>Determination of carbohydrates based on GC-MS analytics</i> Erich Kielhorn, Peter Neubauer, Stefan Junne; TU Berlin
90	4.7	<i>Determination of total Kjeldahl nitrogen and crude protein</i> Michael Dittrich-Zechendorf, DBFZ
93	4.8	<i>Determination of the protein content</i> Lucie Moeller, UFZ; Kati Görsch, DBFZ
95	4.9	<i>Determination of crude fat</i> Michael Dittrich-Zechendorf, DBFZ
98	4.10	<i>Determination of crude fibre</i> Michael Dittrich-Zechendorf, DBFZ
101	4.11	<i>Process specification for the determination of ADF and ADL</i> Michael Dittrich-Zechendorf, DBFZ
104	4.12	<i>Determination of Neutral Detergent Fibre (NDF)</i> Michael Dittrich-Zechendorf, DBFZ
108	5	Methods for gas analysis
108	5.1	<i>Measuring methods for determining gas flow in raw biogas</i> Robert Binder, Manuela Charatjan, Michael Krafzig, Binder Engineering GmbH
114	5.2	<i>Measuring methods for determining gas quality in raw biogas</i> Robert Binder, Manuela Charatjan, Michael Krafzig, Binder Engineering GmbH
121	5.3	<i>Sampling and measurement of siloxanes</i> Ute Merrettig-Bruns, Bettina Sayder, Edda Möhle, Fraunhofer Institute for Environmental, Safety, and Energy Technology UMSICHT
130	5.4	<i>Determination of methane emission potential of liquid manure during storage at ambient temperature</i> Britt Schumacher, Walter Stinner, Katrin Strach, DBFZ; Thomas Amon, ATB

139	5.5	<i>Emission measurements on plants for biological waste treatment</i> Carsten Cuhls, gewitra – Ingenieurgesellschaft für Wissenstransfer mbH; Torsten Reinelt, Jan Liebetrau, DBFZ
147	5.6	<i>Determination of the total emissions from biogas plants by means of optical remote sensing</i> Tanja Westerkamp (former DBFZ)
153	5.7	<i>Monitoring of operational methane emissions from pressure relief valves of biogas plants</i> Torsten Reinelt, Jan Liebetrau, DBFZ
160	5.8	<i>Measurement of volatile organic trace compounds</i> Jorge Iván Salazar Gómez, Andrea Gerstner, Alisa Jovic, Fraunhofer UMSICHT
166	6	Methods for the determination of the physical parameters
166	6.1	<i>Particle size distributions</i> Marc Lincke, Karin Jobst, Fraunhofer IKTS
171	6.2	<i>Determination of the surface tension</i> Lucie Moeller, UFZ; Kati Görsch, DBFZ
172	6.3	<i>Determination of the foaming potential by means of the "bubble test"</i> Lucie Moeller, UFZ; Kati Görsch, DBFZ
174	6.4	LEIPZIG FOAM TESTER – <i>Test set for the determination of the tendency of a substrate to foam</i> Lucie Moeller, Yvonne Köster, Andreas Zehnsdorf, UFZ
177	6.5	<i>Viscosity</i>
178	6.5.1	<i>Measurement methods for the rheologic characterisation of fermentation substrates</i> Manuel Brehmer, Matthias Kraume, TU Berlin
188	6.5.2	<i>Modification of measuring systems for the application to flow behaviour determination of fibrous suspensions</i> Karin Jobst, Marc Lincke, Fraunhofer IKTS
199	6.6	<i>Flow analysis</i>
200	6.6.1	<i>Utilisation of measuring sensors</i> Manuel Brehmer, Matthias Kraume, TU Berlin
206	6.6.2	<i>Electrical Resistance Tomography (ERT)</i> Annett Lomtscher, Fraunhofer IKTS
212	6.7	<i>Determination of the retention time by means of tracers</i> Helge Lorenz, Yong-Sung Kim, René Benndorf, Peter Fischer, DBFZ

219	6.8	<i>Determination of the retention time behaviour with the help of studies of tracers</i> Anne Kleyböcker, GFZ	
222	6.9	<i>Process specification for the determination of sand</i> Katrin Strach, DBFZ	
228	7	Methods for the determination of biological parameters	
228	7.1	<i>Description of the experiment for the Oberhausen/Rostock/Göttingen Activity Test (ORGA-Test)</i> Nils Engler, DBFZ	
232	7.2	<i>Nucleic acid based molecular biology tests</i> Denny Popp, Fabian Bonk, Daniela Becker, Sabine Kleinstеuber, UFZ	NEW
245	7.3	<i>Continuous fermentation tests</i> Marc Lincke, Björn Schwarz; Fraunhofer IKTS	
250	7.4	<i>Continuous fermentation tests</i> Katrin Strach, DBFZ	
259	7.5	<i>Microbiological tests</i> Tobias Lienen ¹ , Patrick Schröder ² , Hilke Würdemann ^{1,2} ¹ Helmholtz Centre Potsdam German Research Centre for Geosciences - GFZ ² Hochschule Merseburg University of Applied Sciences	
263	7.6	<i>Culture based quantification of methanogenic reactor communities</i> Andreas Otto Wagner, Paul Illmer, University of Innsbruck, Institute of Microbiology	
268	7.7	<i>Differentiation of methanogenic pathways in biogas plants using compound-specific stable isotope analysis</i> Anko Fischer, Kevin Kuntze, Isodetect GmbH; Liane Müller, DBFZ; Hans-Hermann Richnow, Marcell Nikolausz, Helmholtz Centre for Environmental Research – UFZ	NEW
280	8	Batch tests	
280	8.1	<i>Inter-Laboratory Test: KTBL/VDLUFA-Proiciency Test Biogas</i> Mark Paterson, Association for Technology and Structures in Agriculture; Hans Oechsner, University of Hohenheim; Peter Tillmann, VDLUFA Quality Assurance NIRS GmbH	NEW

- 295 8.2 *Biogas Interlaboratory Tests at the Bavarian State Research Center for Agriculture (LfL)***
Günter Henkelmann, Christian Vogt, Bavarian State Research Center for Agriculture, LfL
- 304 8.3 *LfL - Batch test***
Vasilis Dandikas, Fabian Lichti, Bavarian State Research Center for Agriculture, LfL
- 309 8.4 *Gas yield test (batch)***
Marc Lincke, Björn Schwarz, Fraunhofer IKTS
- 315 8.5 *GRW-Biogas- and Biomethane Potential Test***
Nils Engler, DBFZ
- 319 8.6 *Determination of the maximum possible biogas output of substrates by disintegration with sodium hydroxide***
Björn Schwarz, Fraunhofer IKTS
- 322 8.7 *Design of an Anaerobic Dry Batch Digestion Pilot Plant System with Provisions to Simulate Full Scale Conditions***
Earl Jenson, Alex Hayes, Steve Mervin, Sylvanus Ekwe, InnoTech Alberta
- 331 8.8 *Specific activity-, toxicity- and supplementingtest (ATS) for the optimization of the facility management of biogas plants***
Mathias Hartel, Bavarian State Research Center for Agriculture
- 336 8.9 *Determination of the residual gas/residual methane potential***
Hans Oechsner, State Institute of Agricultural Engineering and Bioenergy, University of Hohenheim
- 340 8.10 *Gravimetric measurement of BMP***
Sasha D. Hafner, Aarhus University; Brian K. Richards, Cornell University, Ithaca, Sergi Astals, University of Barcelona
- 349 8.11 *Kinetic modelling of anaerobic batch tests***
Sören Weinrich, DBFZ; Sergi Astals, University of Queensland; Sasha D. Hafner, Aarhus University; Konrad Koch, Technical University of Munich
- 370 9 *Calculation and assessment methods***
- 370 9.1 *SWOT analysis***
Christof Heußner, Oliver Kugelstadt, Tobias Bahr, Klaus Fricke, TU Braunschweig
- 373 9.2 *Calculation of plant/process indexes (optimisation potential of individual process steps)***
Christof Heußner, Oliver Kugelstadt, Tobias Bahr, Klaus Fricke, TU Braunschweig

NEW

NEW

NEW

NEW

377	9.3	<i>Determination of the effect of organic fertilisers on the humus supply of soils</i>	Doreen Zirkler and Peter Dominik, TU Berlin
381	9.4	<i>Mass balancing of biogas plants</i>	Sören Weinrich, Jürgen Pröter, Josephine Hofmann, DBFZ; Jürgen Kube, Future Biogas Ltd
393	9.5	<i>Load detection and process control using gas analysis and fuzzy logic</i>	Ernst Murnleitner, Michael Landa, Awite Bioenergie GmbH
400	10	<i>Innovative test equipment and instruments</i>	
400	10.1	<i>Measurement of H₂ (dissolved – gaseous)</i>	Jens Zosel, KSI
405	10.2	<i>In-situ investigation of multiple physico-chemical parameters in the liquid phase of digesters with mobile sensor devices</i>	Anika Bockisch, Stefan Junne, Peter Neubauer, TU Berlin
412	10.3	<i>Determination of methane potential of organic biomass using Automatic Methane Potential Test System (AMPTS II)</i>	Jing Liu, Mihaela Nistor, Sten Strömberg, Bioprocess Control Sweden AB
418	10.4	<i>Determination of carbon compounds (methane, carbon monoxide and carbon dioxide in biogas and biomethane using non-dispersive infrared spectrometry (NDIR))</i>	Michael Landa, Christian Etzkorn, Ernst Murnleitner, Awite Bioenergie GmbH
424	10.5	<i>Substrate suitability assessment for anaerobic dry digestion processes – Method to determine substrate material permeability under compaction</i>	Harald Wedwitschka, Daniela Gallegos, Jan Liebetau, DBFZ; Earl Jenson, InnoTech Alberta
428		Table of tables	
430		Table of illustrations	
436		Table of literature	

Table of abbreviations and symbols

Without SI-units

Abbreviation/ Symbol	Explanation	Unit of Measurement
3D	Three-dimensional	
5-HMF	5-(hydroxymethyl)furfural	
AbfAbIV	German Ordinance on Environmentally Compatible Storage of Waste from Human Settlements and on Biological Waste-Treatment Facilities [Abfallblagerungsverordnung]	
ADF	Acid detergent fibre	% _{TS}
ADL	Acid detergent lignin	% _{TS}
ADM1	Anaerobic digestion model 1	
A _s	Projected area	m ²
ATS	Activity-, toxicity- and supplementation test	
bLS	Backward-Lagrangian Stochastic	
BMP	Biochemical methane potential	L (STP) CH ₄ kg ⁻¹ VS
BMWi	Federal Ministry for the Economic Affairs and Energy	
C	Constant	[-]
c	Volumetric CH ₄ or CO ₂ concentration (assumed to be the same as mole fraction)	%
CA	Crude ash	g kg ⁻¹ TS
C _c	Concentration of the compound of the biogas sample to be tested, relative to specific conditions	mg m ⁻³ (STP)
CCA	Constant current anemometry	
CCD	Cross-correlation development cameras	
c _{CH4}	Measured concentration of methane	m ³ m ⁻³ , %
c _{CO2}	Measured concentration of carbon dioxide	m ³ m ⁻³

Abbreviation/ Symbol	Explanation	Unit of Measurement
cDNA	Complementary deoxyribonucleic acid	
CFD	Computational fluid dynamics	
CFI	Crude fibre	
CFU	Colony-forming units	
CH ₄ -C	Methane carbon	
CHP	Combined heat and power plant	
C _L	End-effect correction factor	[-]
C _{lam}	Constant of the stirrer used	[-]
C _{MO}	Metzner-Otto constant	[-]
CO _{2,eq}	Carbon dioxide equivalent	[-]
COD	Chemical oxygen demand	mg _{COD} L ⁻¹
CSIA	Compound-specific stable isotope analysis	
C _{SR}	Constant of the measuring system for recalculation of the rotation frequency in the shear rate	min s ⁻¹
C _{SS}	Constant of the measuring system for recalculation of the torque in the shear stress	Pa Nm ⁻¹
CTA	Constant temperature anemometry	
CV _R	Coefficient of variation of comparability	%
CV _r	Variation coefficient of repeatability	%
d	Diameter	m
DA	Daily averages	
DAD	Diode array detector	
DAS	Data acquisition system	
DC	Direct current	

Abbreviation/ Symbol	Explanation	Unit of Measurement
DCO₂	Dissolved carbon dioxide	g L ⁻¹
DDGS	Dried distillers grains with solubles	
ddPCR	Digital droplet polymerase chain reaction	
DGGE	Denaturing gradient gel electrophoresis	
d_i	Inner diameter of the PRV exhaust pipe	m
dist	Distilled	
DM	Dry matter	
DNS	Dinitrosalicylic acid	
DO	Dissolved oxygen	% Sat.
d_s	Sensor diameter	m
E(t)	Retention time density function	
ECD	Electron capture detector	
EEG	Renewable Energy Sources Act [Erneubare-Energien-Gesetz]	
EI	Evaluation index	[-]
EMT	Effective mineralisation time	
ERT	Electrical resistance tomography	
EWI	Early warning indicator	
F	System factor	[-]
F(t)	Retention time sum function	
FAL	Bundesforschungsanstalt für Landwirtschaft	
FET	Field effect transistor	
FID	Flame-ionisation detector	

Abbreviation/ Symbol	Explanation	Unit of Measurement
FISH	Fluorescence in situ hybridisation	
FM	Fresh matter	
F_{N_2}	Gas flow velocity	mL min^{-1}
FVS	Fermentable organic volatile solids (also referred to as fermentable organic dry matter)	$\text{kg FVS kg}^{-1} \text{TS}$
FVS_D	Fermentable organic volatile solids (also referred to as fermentable organic dry matter) of the digestate	$\text{kg FVS kg}^{-1} \text{TS}$
FVS_S	Fermentable organic volatile solids (also referred to as fermentable organic dry matter) of the substrate mix	$\text{kg FVS kg}^{-1} \text{TS}$
f_w	Stoichiometric water incooperation	$\text{kg water kg}^{-1} \text{FVS}$
f_x	Microbial biomass formation	$\text{kg biomass kg}^{-1} \text{FVS}$
gas_level_avg	Continuous exponential moving average S_t of the filling level Y_t (%) of the gas storage with a plant specific weight decrease $t_\alpha = 1/3600 \text{ s}$ according to $S_t = \frac{\Delta t}{t_\alpha} * Y_t + \left(1 - \frac{\Delta t}{t_\alpha}\right) * S_{t-1}$	
gas_level_avg2	Continuous exponential moving average of the filling level of the gas storage with a lower weight decrease than gas_level_avg (e.g. 4 times lower)	
GC	Gas chromatograph	
GC-C-IRMS	Gas chromatography - combustion - isotope ratio mass spectrometry	
GC-FID	Gas chromatograph equipped with a flame ionisation detector (FID)	
GC-IRMS	Gas chromatography - isotope ratio mass spectrometry	
GC-MS	Gas chromatograph with mass spectrometer	
GC-P-IRMS	Gas chromatography - pyrolysis - isotope ratio mass spectrometry	
GP 21	Gas production/generation after 21 days	$\text{L (STP) kg}^{-1} \text{VS}$
GWP (value)	Global warming potential	
h	Simulated material height	m
HAc	Acetic acid	

Abbreviation/ Symbol	Explanation	Unit of Measurement
HAC eq	Acetic acid equivalent of all VFAs	[-]
h_{foam}	Height of the generated foam	mm
HHAV	Half-hour average values	
$H_{\text{L,CH}_4}$	Interior calorific value (also referred to as lower heating value) of the biogas (STP)	kWh m ⁻³ (STP)
HPLC	High-performance liquid chromatography	
HRT	Hydraulic retention time	d
IC	Ion chromatography	
ICP-OES	Inductively coupled plasma optical emission spectrometry	
ID	Inner diameter	mm
IR	Infrared	
IRIS	Isotope ratio infrared spectroscopy	
ISO	International organization for standardisation	
ISTD	Internal standard	
k	First-order reaction constant	1 d ⁻¹
K	Ostwald factor	Pa s ⁿ
K	Hydraulic conductivity	m s ⁻¹
K^*	Consistency factor of the flow curve based on the rotational frequency	mPas ^m
k', k''	METZNER/REED flow factor	Pas ^{n'}
k_1	First-order degradation constant of substrate fraction 1	d ⁻¹
$K_{1/s}$	Consistency factor of a defined range of the shear rate: consistency factor for the apparent viscosity at a shear rate of $\dot{\gamma} = 1 \text{ s}^{-1}$	mPa s ^m
k_2	First-order degradation constant of substrate fraction 2	d ⁻¹

Abbreviation/ Symbol	Explanation	Unit of Measurement
KrWG	Closed Substance Cycle Waste Management Act [Kreislaufwirtschafts- und Abfallgesetz]	
k_{VFA}	First-order degradation constant of volatile fatty acids (VFA)	d^{-1}
K_{VP}	Factor for the recalculation of the regarding rotational frequency of the stirrer in the relevant shear rates	[-]
L	Characteristic length	m
L2F	Laser-2-focus anemometry	
LBP	Linear back projection	
LDA	Laser Doppler anemometry	
LEL	Lower explosive limit	%
L_o	Obukhov-length	m
LOD	Limit of detection	
LOQ	Limit of quantification	
LTR	From left to right	
M	Torque	Nm
m	Mass	kg
\bar{m}	Mean value (Ch. 8.1, PATERSON)	
MATLAB	MATrix LABoratory	
M_B	Molar mass of biogas	$g\ mol^{-1}$
MCF	Methyl chloroformate	
$mg_{COD/L}$	Milligrams of COD (chemical oxygen demand) per litre	
MGRT	Minimum guaranteed retention time	
m_{H_2O}	Mass of water in biogas	$g\ L^{-1}$
MID	Magnetic flow meter	

Abbreviation/ Symbol	Explanation	Unit of Measurement
MPN	Most probable number	MPN g ⁻¹
MS	Mass spectrometer	
MYA	Malt yeast agar	
N	Rotational frequency	1 s ⁻¹
N	Neutron (Ch. 7.7, FISCHER)	
n	Flow exponent	[-]
n	Number of measurements (Ch. 8,11, WEINRICH)	[-]
n'	METZNER/REED index	[-]
n''	HERSCHEL/BULKLEY index	[-]
n-N	non-Newtonian	
Nd:YAG	Neodymium yttrium aluminium garnet double pulse laser	
NDF	Neutral detergent fibre	% _{TS}
NDIR	Non-dispersive infrared absorption (spectrometry)	
Ne	Newton number (power indicator)	
NGS	Next generation sequencing	
NH ₄ -N	Total ammonia nitrogen (TAN)	
NMVOC	Non-methane [volatile] organic compounds	
NO ₂ -N	Nitrite nitrogen	
NO ₃ -N	Nitrate nitrogen	
OBA	Online Biogas App (https://biotransformers.shinyapps.io/oba1/)	
ORGA-Test	Oberhausen-Rostock-Göttinger activity test	
OLR	Organic loading rate	kg VS m ⁻³ d ⁻¹ , g VS L ⁻¹ d ⁻¹

Abbreviation/ Symbol	Explanation	Unit of Measurement
OTU	Operational taxonomic unit	
p	Pressure	Pa, kPa
P	Proton (Ch. 7.7, FISCHER)	
P	Power input (stirrer power)	W
p.a.	Pro analysi (analytical grade)	
P_{Air}	Atmospheric pressure measured on-site the biogas plant	hPa
P_{el}	Electrical power of the CHP	kW
P_{RTI}	Power total rated input	kW
PIV	Particle image velocimetry	
ppb	Parts per billion	
ppm	Parts per million	
ppm * m	Parts per million times metre(s)	
ppmv	Parts per million by volume	
PTB	Physikalisch-Technische Bundesanstalt (Physical Technical Federal Institute)	
Q	Flow rate	$m^3 s^{-1}$
Q_0	Number distribution	%
$q_0(x_{EQPC})$	Number density distribution (of the type of quantity "number" 0) of the coextensive circle diameter	$1 \mu m^{-1}$, % μm^{-1}
$Q_0(x_{EQPC})$	Cumulative distribution (of the type of quantity "number" 0) of the coextensive circle diameter	[-], %
$q_3(x_{EQPV})$	Volume density distribution (of the type of quantity "number" 3) of the coextensive sphere diameter	$1 \mu m^{-1}$, % μm^{-1}
$Q_3(x_{EQPV})$	Volume cumulative distribution (of the type of quantity "number" 3) of the coextensive sphere diameter	%
qPCR	Quantitative polymerase chain reaction	
PAO	Phosphate accumulating organisms	

Abbreviation/ Symbol	Explanation	Unit of Measurement
PLC	Programmable logic controller	
PRV	Pressure relief valve	
r	Radius	mm, m
r	Repeatability (Ch. 8.1, PATERSON)	[-]
R	Comparability	[-]
R_1	Resistance	Ω
R_2	Resistance	Ω
R_{CR}	Control resistance	Ω
Re	Reynolds number	[-]
RenFe [NaWaRo]	Renewable feedstock [Nachwachsende Rohstoffe]	
RGP	Residual gas potential	%
r_i	Inner radius	mm
RID	Refractive index detector	
Rm	Maximum biogas methane production rate	$L\ kg^{-1}\ VS\ d^{-1}$
r_o	Outer radius	mm
RNA	Ribonucleic acid	
rRNA	Ribosomal ribonucleic acid	
R_s	Sensor resistance	
R_{sample}	Stable isotope ratio (e.g. $^{13}C/^{12}C$, $^2H/^1H$) of the sample	[-]
$R_{standard}$	Stable isotope ratio (e.g. $^{13}C/^{12}C$, $^2H/^1H$) of the international standard	[-]
RSD	Relative standard deviation	%

Abbreviation/ Symbol	Explanation	Unit of Measurement
S(t)	Time-dependent cumulative biogas methane yield	L kg ⁻¹ VS
SBP	Specific biogas production	mL g ⁻¹ VS
S _{max}	Biogas methane potential (maximum potential)	L kg ⁻¹ VS
SMP	Specific methane production	mL g ⁻¹ VS
STD	Standard/standardised	
STP	Dry and at standard temperature and pressure at at 101.325 kPa and 0 °C	
S _R	Comparison standard deviation	%
S _r	Repeat standard deviation	%
SWOT	S-strength, W-weakness, O-opportunities, T-threats	
t	Time or time constant for conversion of m ³ s ⁻¹ in m ³ h ⁻¹	3,600 s h ⁻¹
T	Actual temperature of the biogas sample	°C
TA Luft	Technical Instructions on Air Quality Control [Technische Anleitung zur Reinhaltung der Luft]	
TAN	Total ammonia nitrogen (NH ₄ -N)	
TC	Total carbon	
TD	Thermal desorption	
TDLAS	Tunable diode laser absorption spectrometer	
T _f	Fluid temperature	°C
TGB	Trypton glucose bouillon	
TN	Total nitrogen	
TOC	Total organic carbon	
tol _{up}	Upper tolerance level (according to VDLUFA method)	[-]

Abbreviation/ Symbol	Explanation	Unit of Measurement
tol_{low}	Lower tolerance level (according to VDLUFA method)	[-]
T-RF	Terminal restriction fragment	
T-RFLP	Terminal restriction fragment length polymorphism	
T_s	Sensor temperature	°C
TS	Total solids (also referred to as dry matter)	kg bzw. %
TS_D	Total solids of the digestate	kg TS kg ⁻¹ FM
TS_{md}	Total solids, dried and milled	kg bzw. %
TS_s	Total solids of the substrate mix	kg TS kg ⁻¹ FM
TS_k	Corrected TS. If a material contains volatile solids, particularly volatile fatty acids (VFA) or alcohols, a correction of the TS is necessary according to a method proposed by WEISSBACH & STRUBELT.	% FM
TS_{KF}	Total solids content – Karl-Fischer-method	g kg ⁻¹ , g L ⁻¹ , %
U	Heater voltage	V
u*	Friction rate	m s ⁻¹
U_B	Bridge voltage	V
UEL	Upper explosive limit	%
v	Velocity	m s ⁻¹
V	Volume	mL, L
v_{avg}	Average velocity	m s ⁻¹
V_B or V_{CH_4}	Dry standardised biogas or methane volume at STP	m ³ , mL, L STP
V_{CH_4} (real)	Released methane volume in process conditions	m ³
VDLUFA	Association of German Agricultural Analytic and Research Institutes [Verband Deutscher Landwirtschaftlicher Untersuchungs- und Forschungsanstalten]	

Abbreviation/ Symbol	Explanation	Unit of Measurement
VFA	Volatile fatty acid	e.g. mg HAC eq L ⁻¹
V _{foam}	Volume of the generated foam	mL
V _{GP}	Volume of the gas phase in the reactor	mL
V _{STPD-CH₄}	Released methane volume in normal conditions and dry	m ³ STPD
V _{tot}	Total volume	mL
VOA	Volatile organic acids	mg L ⁻¹
VOC	Volatile organic compounds	
V-PDB	Vienna-Pee Dee Belemnite, International standard for quoting carbon stable isotope ratios (¹³ C/ ¹² C) in the delta notation (δ ¹³ C-value)	
VS	Volatile solids (also referred to as organic dry matter)	% TS, kg VS kg ⁻¹ TS
VS _D	Volatile solids (also referred to as organic dry matter) of the digestate	kg VS kg ⁻¹ TS
VS _{FM}	Volatile solids (also referred as organic fresh matter)	%, kg VS kg ⁻¹ FM
W	Wall	
WC	Water content	
x	Independent variable (Ch. 8.11, Weinrich)	
x _{CH₄}	Normalized mole fraction of CH ₄ in biogas	[dimensionless, mole fraction]
x _{EQPC}	Area diameter	μm
x _{EQPV}	Volume sphere diameter	μm
x _{max}	Fibre length	mm
y	Dependent variable	[-]
y	Variable for individual measurements	L kg ⁻¹ VS

Abbreviation/ Symbol	Explanation	Unit of Measurement
\bar{y}	Mean value of all measurements	L kg ⁻¹ VS
\hat{y}	Model output simulation results	L kg ⁻¹ VS
Y_{FVS}	Biogas (formation) potential of fermentable organic volatile solids (STP)	m ³ (STP) kg ⁻¹ FVS
Y_D	Specific residual gas potential (STP)	m ³ (STP) kg ⁻¹ FM
z_o	Roughness length	m
z_{up}	Upstream length	m

Special characters	Explanation	Unit of measurement
$^{13}\text{C}/^{12}\text{C}$	Carbon stable isotope ratio	[-]
$^2\text{H}/^1\text{H}$	Hydrogen stable isotope ratio	[-]
α	Ratio of substrate fraction 1 to total degradable substrate	[-]
Δm	Mass loss for a single BMP bottle during a single incubation interval	g
$\dot{\gamma}$	Shear rate	1 s^{-1}
$\dot{\gamma}^*$	Shear rate calculated according to manufacturer's instructions	1 s^{-1}
$\dot{\gamma}_{\text{rep}}$	Representative shear rate	1 s^{-1}
δ	Radius ratio	[-]
δ_{sample}	Delta-value expression of stable isotope ratio for the sample	‰ or mUr
$\delta^{13}\text{C}$ -value	Carbon stable isotope ratio ($^{13}\text{C}/^{12}\text{C}$) given as delta notation	‰ or mUr
$\delta^{13}\text{C}_{\text{CH}_4}$ -value	Carbon stable isotope ratio ($^{13}\text{C}/^{12}\text{C}$) of methane given as delta notation	‰ or mUr
$\delta^{13}\text{C}_{\text{CO}_2}$ -value	Carbon stable isotope ratio ($^{13}\text{C}/^{12}\text{C}$) of carbon dioxide given as delta notation	‰ or mUr
$\delta^2\text{H}_{\text{CH}_4}$ -value	Hydrogen stable isotope ratio ($^2\text{H}/^1\text{H}$) of methane given as delta notation	‰ or mUr
$\delta^{13}\text{C}_{\text{Substrat}}$	Carbon stable isotope ratio ($^{13}\text{C}/^{12}\text{C}$) of substrate given as delta notation	‰ or mUr
$\Delta 13\text{C}$	Difference between carbon isotope ratios of methane or carbon dioxide and biogas substrate ($\Delta^{13}\text{C} = \delta^{13}\text{C}_{\text{CH}_4} - \delta^{13}\text{C}_{\text{Substrat}}$ or ($\Delta^{13}\text{C} = \delta^{13}\text{C}_{\text{CO}_2} - \delta^{13}\text{C}_{\text{Substrat}}$)	‰ or mUr
$E_w(\vartheta)$	Released biogas volume flow under process conditions	hPa
η	Dynamic viscosity (Ch. 6.5.1 BREHMER, Ch. 6.5.2 JOBST)	kg ms^{-1}
η	Conversion of FVS (Ch. 9.4, WEINRICH)	kg FVS kg^{-1} FVS
η_{eff}	Effective viscosity	kg ms^{-1}
η_{el}	Electrical efficiency of the CHP	kW kW^{-1}
$\eta_{\text{n-N}}$	Viscosity for non-Newtonian fluids	$\text{N m}^{-2}, \text{Pa s}$
η_{s}	Apparent viscosity	mPas, Pas

Special characters	Explanation	Unit of measurement
θ_{biogas}	Biogas temperature measured in the exhaust pipe of the PRV during a release event	$^{\circ}\text{C}$
λ	Lag-time	d
\dot{m}	Shear stress	$\text{N m}^{-2}, \text{Pa s}$
\dot{m}_{D}	Mass flow of the digestate	kg d^{-1}
\dot{m}_{S}	Mass flow of the substrate mix	kg d^{-1}
ρ	Density (STP)	$\text{kg m}^{-3}, \text{kg m}^{-3} \text{ (STP)}$
ρ_{B}	Density of the biogas (STP)	$\text{kg m}^{-3} \text{ (STP)}$
$\sigma_{\text{p}(x,y)}$	Electrical conductivity of the pixels	mS cm^{-1}
τ	Shear stress	$\text{N m}^{-2}, \text{Pa s}$
τ^{W}	Shear stress near the wall	$\text{N m}^{-2}, \text{Pa s}$
\bar{t}	Average retention time	s
\bar{v}	Mean flow velocity	m s^{-1}
\dot{V}_{CH_4}	Released methane volume flow under process conditions	$\text{m}^3 \text{ h}^{-1}$
\dot{V}_{B}	Volume flow (rate) of the biogas (STP)	$\text{m}^3 \text{ (STP) d}^{-1}$
ω	Angular velocity	1 s^{-1}

1 Introduction

Anaerobic digestion (AD) processes represent a successful and promising option for the energy provision based on biomass. The number of plants has been increasing continuously in Germany. With approx. 9,800 plants (DANIEL-GROMKE et al. 2017), the biogas technology is referred to as an established technology. Nevertheless, a significant optimisation potential exists with respect to the efficiency of the conversion and utilisation processes at AD plants and as a response to changing conditions within the market as well as legal regulations. AD plants can contribute to the emission reduction in the energy sector through a stable energy supply. This is realized by means of controllable and weather-independent provision of electricity and heat or biomethane. Furthermore, AD plants offer benefits by either using organic residues and waste materials or converting them into valuable products as organic fertilizers.

Since 2009, more than 70 of totally about 180 projects in the German research network “Bioenergy” have been primarily addressing the effective utilisation of residues and waste to biogas. For this purpose innovative process combinations are developed, the fermentation process is optimized, and the possible options for use of the generated biogas is expanded. The projects focus in particular on the aspect of sustainability, especially on measures to mitigate greenhouse gas emissions. In addition, there is a growing need for flexibility regarding the substrate, energy and material provision (polygeneration). Thus, challenges increase for operation, monitoring and control of biogas facilities in all dimensions.

In addition to the individual research activities and objectives of the projects, the idea of compiling the several applied methods in the “Collection of Methods for Biogas” was developed jointly across the biogas related projects within the research network.

Despite the considerable number of industrial-scale biogas systems, the process-accompanying analytics and the scientific methods of analysis are facing a multitude of challenges resulting from the special characteristics of the substrates and the technical process. The measurement methods used in the biogas sector were mostly adopted from applications in other scientific fields (e.g. waste management or chemical industries) and – in the great majority of cases – have to be adapted in order to apply them in practice.

Several methods presented here are applied after a consistent methodological approach with a differing degree of necessary modifications up to completely new developments (e.g. VOA/buffer capacity) that have not yet been standardised. The great variability of the content of the projects involved also results

in a great variability of the methods that present virtually the whole spectrum of biogas research. Because of the difficulties within the measurements and a lack of standardisation, numerous variants of methods were created that often make a sensible comparison of the results between the projects impossible. At the beginning of each chapter, the methods used were compiled to a concise overview in order to provide an evaluation and, in the long-term, to enable a broader discussion on harmonizing the methods with the institutions using them. The collection does not claim to be a selection of fully developed methods with a detailed description of all methods. It is rather a collection of approaches and ideas, which shall help the researchers and practitioners to find solutions for problems or at least find contacts to discuss specific questions.

Therefore, the “Collection of Methods for Biogas” provides, for the first time, the opportunity to give an overview of the methods used in the biogas sector and to perform comparisons with respect to the suitability of specific applications. In addition, the collection of measurement methods offers readers the opportunity to identify institutions that deal with the methods presented, to exchange experiences and to further develop the methods.

If you would like to contribute additional methods to the “Collection of Methods for Biogas” or if you have comments and/or suggestions for adjustments regarding the current edition, please contact:

Diana Pfeiffer

+49 (0)341 2434 554
diana.pfeiffer@dbfz.de

The methods introduced here are utilised in technical processes and procedures that serve the conversion of biomass to biogas and its subsequent utilisation. Both waste treatment plants and agricultural plants are being reviewed. Furthermore, the methods delineated in this collection refer to a complex process that is being realised, in practice, in a multitude of variations.

The methods presented in the chapters on fundamental parameters, as well as others such as chemical, physical and biological parameters describe the material characteristics of the initial substrates, the digester content, as well as the products. These methods are used in order to describe the quality of the initial substrates and end-products as well as process states in the fermentation process. They serve as initial parameters for overall investigations such as process assessments, mass and energy balances. The evaluation of emissions also serves this overriding framework. For this, it is necessary to determine the quality and quantity of the emitted substances. In the few cases in which different methods for the same measured parameter were used these were presented equivalently.

In the chapter on calculation and assessment methods, comprehensive methods such as the SWOT analysis, mass balancing, or the determination of process indexes are presented. These are utilised to assess the overall process or sub-processes with respect to their technical suitability or the energetic efficiency.

Several new chapters on methods for gas analysis, the requirements of the procedures of batch and interlaboratory tests, as well as innovative test equipment and instruments were included in 2019 and 2020.



2 Definitions

Term	Explanation
Acetoclastic methanogenesis	Formation of methane via conversion of acetate ($\text{CH}_3\text{COOH} \rightarrow \text{CH}_4 + \text{CO}_2$)
Activated sludge (inoculum)	Microbial biomass that is utilised to start or accelerate a \rightarrow fermentation; mostly digestate from active \rightarrow AD plants.
Amount of biogas produced (Absolute biogas yield)	e.g. in L \rightarrow Biogas generated in unit of volume. The amount of biogas produced is the volume of the raw biogas quantity converted to standard conditions in accordance with DIN 1343 (0% relative humidity; 273 K gas temperature; 1013.25 hPa ambient pressure).
Anaerobic chamber (glove box)	A sealed container enabling the removal of atmospheric oxygen by flushing it with nitrogen gas.
Anaerobic degradability	Degree of fermentable substrate components (FVS) to organic substrate (VS) components.
Anaerobic digestion plant (AD plant)	\rightarrow biogas plant
Anaerobic treatment	Biotechnological process in the absence of air (oxygen) with the objective of the decomposition of organic matter while generating \rightarrow biogas.
Ash	Inorganic total solids (also referred to as inorganic dry matter); residue on ignition, is generated in accordance with DIN EN 15935 (or DIN EN 14775; VDLUFA) at 550 °C from the \rightarrow total solids (also referred to as dry matter) (TS); represents the inert share of the sample of the \rightarrow substrate or digestate.
Batch test	Discontinuous test in which organic \rightarrow substrates or \rightarrow co-substrates are subjected to a \rightarrow fermentation under defined anaerobic conditions and in which insights regarding the fermentability and \rightarrow gas yield or potential, respectively, can be gained.
Biogas	Gaseous product of \rightarrow fermentation that mainly consists of methane and carbon dioxide and which, depending on the \rightarrow substrate, may also contain ammonia, hydrogen, hydrogen sulphide, steam and other gaseous or evaporable components.
Biogas (formation) potential	e.g. in L kg^{-1} VS Highest achievable \rightarrow specific biogas yield that can be generated from a defined amount of substrate under anaerobic conditions for a given substrate condition (degree of substrate pretreatment and microbial growth).
Biogas methane content	The biogas methane content is the volume share of methane contained in one unit of volume of \rightarrow biogas.

Term	Explanation
Biogas plant (also referred to as anaerobic digestion plant)	Structural unit for the production of biogas from the materials supplied, consisting of at least one or more →digesters as well as the piping and cabling required for this. Generally, a biogas plant also includes stockpiling and feeding facilities for the fermentation substrates, gas purification and gas utilisation systems (e.g. CHP) as well as storage and occasionally also processing options for the →digestates and the →biogas in natural gas quality (e.g. with the objective of injecting it into the natural gas grid or delivery as fuel). (in accordance with VDI 3475 Sheet 4)
Biogas processing	All technically required facilities included for the removal of unwanted components of the →biogas and thus for methane enrichment →gas purification.
Biogas rate	e.g. in $L d^{-1}$ →Amount of biogas produced per unit of time.
Biogas rate, specific (biogas productivity)	in $L L^{-1} d^{-1}$ Relationship of the →biogas rate to the active working volume of the →digester.
Biogas yield, specific	e.g. in $L kg^{-1} VS$ or $L kg^{-1} FM$ Specific amount of biogas produced per amount of substrate used.
Biomass	Biomass is living organic matter of plant or animal origin or from fungal materials. This also includes secondary products and by-products resulting from these materials. The differentiation of biomass from fossil energy sources begins with peat, the fossil secondary product of rotting (KALTSCHMITT et al. 2016).
Biowaste	Waste of animal or plant origin or from fungal materials for recovery purposes, which can be degraded by microorganisms, soil-borne organisms or enzymes, including wastes for recovery purposes with high organic content of animal or plant origin or fungal materials (BioABFV 1998 [amendment 2013, 2017]).
Blank test (zero test)	Fermentation test with pure →activated sludge without the addition of →substrate.
C3-plant	A plant in which the CO_2 is first fixed into a compound containing three carbon atoms (3-phosphoglycerate) before entering the Calvin cycle of photosynthesis.
C4-plant	A plant in which the CO_2 is first fixed into a compound containing four carbon atoms (oxaloacetate) before entering the Calvin cycle of photosynthesis.
cDNA	Stretch of DNA that is complementary to an RNA sequence and generated by reverse transcriptase. As RNA is less stable than DNA, cDNA is used for RNA-based activity analysis of microorganisms.

Term	Explanation
Chemical oxygen demand (COD)	in mg COD L ⁻¹ Metric for the share of oxidisable compounds in the substrate.
Co-digestion	(here) Anaerobic biotechnological process in which a (main)→substrate is fermented jointly with one or more additional →substrates (→co-substrates).
Co-substrate	Feedstock for a →fermentation/→digestion which, however, is not the raw material with the highest percentage share in the overall material flow to be fermented.
Composite sample	A sample that was created by combining and mixing →individual samples from a basic quantity.
Content of volatile solids (VS)	in g VS kg ⁻¹ FM and/or g VS L ⁻¹ FM The weight loss (volatile solids burn loss) of a sample relative to a) the untreated original sample (→fresh matter), the initial volume that is turned to ash or b) the total solid content of the sample. Ignition carried out at a temperature of 550 °C until a constant weight is reached (DIN EN 15935). The weight loss is primarily, but not exclusively, caused by organic contents. Determination includes usually a drying step with determination of total solids (TS). Volatile organic substances that escape during the drying at 105 °C are not captured with this method and have to be determined separately.
Cumulative sample	See →composite sample.
Degree of degradation, in %	Reduction of mass of the organic substance due to anaerobic degradation relative to the initial amount of →substrate or analytically determined reference values of the substrate. Common reference values are FM, TS, VS, FVS, COD, TOC.
Degree of desulphurisation	Describes the degree of the elimination of sulphur compounds in the →biogas by means of biological, chemical or physical desulphurisation processes.
δ-value	Delta-value expression of the stable isotope ratio.
Delta notation	Abundance of isotope A of element X in a sample relative to the abundance of the same isotope in an arbitrarily designated reference material or isotope standard with known isotope composition.
Digestate	Once the fermentation mix is leaving the →digester, it is referred to as digestate. Digestate is quite often utilised as →inoculum. The →residual gas potential is determined with the digestate.
Digestate processing	Facilities and plant components for the processing of →digestates.

Term	Explanation
Digestate storage unit	Vessel or earthen basin in which →digestate is stored unheated and open, covered or gastight covered prior to further utilisation and processing. Digestate storage units are fed by →digesters. A digestate storage unit is not primarily intended to generate methane. The filling level and the temperature are subject to severe fluctuations over the course of the year.
Digested sludge	Digested sewage sludge (see also →activated sludge).
Digester (also referred to as fermenter)	Vessel that serves for the targeted conversion (fermentation) of the →fermentation mix by microorganisms. Digesters for biogas production are characterised by the fact that the digester medium (→fermentation mix) contained therein is being tempered, an active transport of material is maintained (e.g. through stirring or percolation), and the biological process is actively controlled. Digesters are furthermore characterised by the fact that the →biogas generated is captured and made available for use. In general, a differentiation can be made between →pre-digesters, →main digesters, and →post-digesters.
Digester volume (also referred to as active fermenter volume or liquid fermenter volume)	Portion of the volume of the →digester (vessel) in which the →fermentation takes place.
Digestion (also referred to as fermentation)	Synonym for →fermentation and anaerobic treatment (this term is also often used in wastewater treatment).
Discharge concentration	Concentration of a substance in the discharge (e.g. content of volatile solids in kg VS m^{-3}).
Discharge load	e.g. in kg VS d^{-1} or in kg TS d^{-1} or kg FM d^{-1} Amount of mass discharged from a fermentation plant per unit of time.
Energy crops	Crops that are cultivated for the sole purpose of producing energy.
Feeding	The addition of substrate to a →digester is called feeding.
Feedstock from renewable resources (RenFe)	Crops that are cultivated for the purpose of utilisation for energy and/or material.
Fermentation	Microbial or enzymatic conversion of organic substances into acids, gases or alcohol = Aerobic and anaerobic metabolic reactions of microorganisms to obtain products, biomass or for biotransformation (SPEKTRUM 2001)
Fermentation aids (additives)	All materials and/or working media fed to the →digester for promoting the microbial decomposition processes that are not →substrate. The fermentation aids themselves do not have any →biogas (formation) potential and/or it is negligibly low. Fermentation aids can be of organic or inorganic composition (e.g. algae preparations, trace elements for the supply of the microorganisms, enzymes for the hydrolysis).

Term	Explanation
Fermentation mixture (digester/fermenter content, fermentation media)	→Substrate, including →fermentation aids, recirculates and biocoenosis in a →digester. In case of a CSTR synonym for →digestate.
Fermentation product	The products in solid, liquid and gaseous form generated through fermentation, in the case of agricultural →biogas plants: →biogas and →digester residue.
Fermentation residue	Solid or liquid material remaining after processing or storage of the →digestate (VDI 4630) (synonym for bio fertilizer)
Fermenter	→Digester
Fermenter volume	→Digester volume
Floating sludge layer (scum layer)	Layer or cover on the surface of the digestate inside the digester.
Foam	Gas bubbles building on top of the digestate surface separated by lamellas of liquid whose structure can stabilise itself through media contents (e.g. proteins).
Fresh matter (FM)	Mass of a substance or →substrate in the original state with the natural water content (synonym for wet weight)
Gas production (GP 21)	e.g. in $\text{L kg}^{-1} \text{VS}$ (in 21 d) →Gas yield in a specific →batch test after a finite, defined period of time (e.g. gas production GP 21; see Ordinance on Environmentally Compatible Storage of Waste from Human Settlements and Biological Waste-Treatment Facilities [AbfAbIV] or [VDI 4630]).
Gas purification	→Biogas processing
Gas storage	Technical facility/equipment for the storage of →biogas in various integrated or separated designs
Gas yield	See →biogas yield and →methane yield.
Homogeneity/inhomogeneity	Degree of even/uneven distribution of a characteristic value/material in a quantity of material; a material may be homogeneous with respect to an analyte or a characteristic, but inhomogeneous with respect to another one.
Hopper	A storage container/vessel with feeding technology for solid or liquid, →substrates and →fermentation aids.
Hydraulic retention time (HRT)	e.g. in d Average retention time of the →substrate in the →digester (The frequently used quotient of the working volume to the daily fed-in substrate volume is applicable only under the assumption of a volume-constant reaction). $\text{HRT} = \frac{V_{\text{reactor}}}{\dot{V}}$

Term	Explanation
Hydrogenotrophic methanogenesis	Formation of methane via hydrogen and carbon dioxide ($\text{CO}_2 + 4 \text{H}_2 \rightarrow \text{CH}_4 + 2 \text{H}_2\text{O}$)
Hydrolysis gas	Product of the biochemical hydrolytic substrate breaking-down. Main components are carbon dioxide and hydrogen with small shares of methane, hydrogen sulphide, as well as other volatile organic compounds.
Impurities	Substances that interfere negatively with the process, the technology, or the product quality (e.g. plastic, glass or metal particles, and sand).
Inhibition	Hindering of \rightarrow fermentation through damage of the active microorganisms or reduction of the efficiency (activity) of enzymes.
Input	\rightarrow Feeding into the system (system boundary).
Input concentration	e.g. in kg VS m^{-3} or in kg TS m^{-3} Concentration of a substance in the input.
In-situ	Measurement directly in the liquid phase of a fermentation or cultivation medium without any bypass or sampling steps.
Isotopes	Variants of a particular chemical element, which have the same number of protons but vary in the number of neutrons, and have therefore different atomic masses.
Isotope ratio (isotope signature)	Quotient between the heavy and the light stable isotope (e.g. $^{13}\text{C}/^{12}\text{C}$, $^2\text{H}/^1\text{H}$)
Mass balance	Balancing of all mass flows entering and exiting the system (balance boundary).
<i>mcrA</i> gene	Gene encoding the alpha subunit of methyl-coenzyme M reductase, which catalyses the final step in methane formation. <i>mcrA</i> genes are used as functional marker for analysis of the methanogenic community in biogas reactors.
Metagenomics	Molecular biological approach to characterise the composition and metabolic potential of a microbial community by high-throughput sequencing of the total genomic DNA.
Methane yield	Product of the \rightarrow biogas yield and the \rightarrow biogas methane content.
Methane yield, specific	The product of the \rightarrow biogas yield and the \rightarrow biogas methane content in relation to the organic substance used (VS). in $\text{L CH}_4 \text{g}^{-1} \text{VS d}^{-1}$
Methane productivity, specific	in $\text{L CH}_4 \text{L}^{-1} \text{d}^{-1}$ Relationship of the amount of methane generated per unit of time to the active working volume of the \rightarrow digester.

Term	Explanation
Multiphase methane processing	The term phase refers to the microbial process. A differentiation is made between a single-phase methane fermentation. In the two-phase process, the aim is to spatially separate acid and methane formation.
Multi-stage biogas plant	A multi-stage biogas plant is characterised by the fact that subsequent (process) phases occur in cascading →digesters. A multi-stage biogas plant can, for example, consist of a →pre-digester, a →main digester and a →post-digester that are connected in series.
On-line	Continuous and automated measurement with real-time acquisition and without any sample preparation step in between.
Organic loading rate (OLR)	in $\text{kg VS m}^{-3} \text{ d}^{-1}$ Relation of the →daily load to the →digester volume.
Output	Discharge from a balance space.
Pollutants ((or inhibitors)	Substances that inhibit the fermentation process (→inhibition) or negatively affect the usability of the →fermentation product.
Process temperature	The process temperature is the average temperature in the →digester as the mean in the case of the utilisation of multiple measurement sites.
Reactor	→fermenter
Recirculate	→Fermentation mix or →digestate that is fed back into a →digester in part (e.g. only the liquid phase after separation) or in whole after having left it.
Reference substrate (control)	→Substrate with known biogas potential (e.g. microcrystalline cellulose).
Representative sample	Sample whose characteristics correspond, for the most part, to the average characteristics of the basic quantity of the entire lot.
Residual gas potential	Represents the biogas or methane potential of the digestate and is determined in laboratory tests under defined conditions. It is given in relation to the →wet weight, →organic dry matter of the →digestate or at the plant produced amount of gas, indicating the temperature and duration selected for the test. The residual gas potential is sometimes also determined at 20 °C and is then interpreted as an estimate of the emission potential of the digestate.
16S rRNA gene	Gene encoding the ribosomal RNA that forms the small subunit of prokaryotic ribosomes. 16S rRNA genes are used as phylogenetic marker in microbial community analysis.
Sample preparation	Establishing of the sample characteristics required for a representative analysis via separating, comminution, classifying, etc.

Term	Explanation
Sampling	Type of the extraction and preparation of portions of the →substrate or of the digester content in order to obtain relevant and representative information regarding the chemical or biological parameters of the overall amount.
Sediment	Deposits of solids in →digesters and storage vessels/containers.
Single-phase methane fermentation	The microbial sub-steps of hydrolysis, acidic fermentation and methane production take place without spatial separation.
Single sample	Sample amount that is extracted in a single sampling process; temporally and location-wise it is limited to the extraction site.
Single-stage biogas plant	A single-stage biogas plant is characterised by the fact that all →phases up to the →biogas take place in one digester or multiple →digesters connected in parallel.
Sludge load	in $\text{kg VS kg}^{-1} \text{VS d}^{-1}$ Relationship of the →daily load (kg VS d^{-1}) to the volatile solids in the →digester.
Specific stirrer power	The specific stirrer power is the average power demand of the stirrer systems used for mixing the digester, determined as electrical effective power, relative to the respective digester volume used.
Storage of sample(s)	Type of bridging the time between →sampling, →sample preparation and utilisation of the sample in chemical analyses or biological test.
Substrate (→biomass)	Raw material for a →fermentation, here →digestion.
Total ammonia nitrogen content (TAN) ($\text{NH}_4\text{-N}$ -content)	The total ammonia nitrogen content (TAN) is the sum of nitrogen compounds of each process stage present in the form of NH_4^+ ions and undissociated NH_3 .
Total nitrogen content (Kjeldahl nitrogen, TKN)	The total nitrogen content is the sum of the nitrogen contained in inorganic and organic nitrogen compounds in the →input (see DIN EN 25663).
Total solids content (TS)	In g kg^{-1} , g L^{-1} , or % of the total amount (→fresh matter) (% FM). Share of substances that remain upon thermal removal of (e.g. according to DIN EN 15934, drying for 24 hours at 105 °C and/or until a constant weight is achieved). In addition to water, other volatile components (e.g. volatile organic acids) are also driven out, where applicable.
Total solids content – Karl-Fischer-method (TS_{KF})	In g kg^{-1} , g L^{-1} , or % of the total amount (→fresh matter (% FM)). Determination according to Karl-Fischer or by means of azeotropic distillation (xylol or toluol method). Here, the water content (WC) is determined directly.
Total solids content milled (TS_{md})	Unlike →TS, TS_{md} refers to a sample that is dried, milled and again dried, as the sample gains water during the milling.

Term	Explanation
Trace gas concentration	The trace gas concentration is the share of gaseous accompanying substances in the →biogas prior to the gas utilisation (e.g. hydrogen sulphide, ammonia, siloxanes).
VAN-SOEST carbohydrate analysis	The VAN-SOEST carbohydrate analysis aims for the separation of the cell wall components in the carbohydrates cellulose, hemicellulose and lignin. In comparison to the →WEENDER feed analysis, a distinction of the carbohydrates is possible. It is, just like the →WEENDER feed analysis, a convention method.
VOA/buffer capacity value	<p>The VOA/buffer capacity value is the quotient of the amount of →volatile organic acids (VOAs) determined by means of titration with 0.1 N sulphuric acid, expressed as mg L⁻¹ acetic acid equivalent (HAc) and the acid consumption of the same titration up to pH = 5 (buffer capacity) expressed as mg CaCO₃ L⁻¹.</p> <p>The VOA/buffer capacity value is of purely empirical nature and constitutes an early warning parameter for assessing process stability. For a stable operation, a limit value of < 0.3 is considered safe. In the case of pure feestock from renewable resources, a stable operation is still achieved at VOA/buffer capacity values between 0.4 and 0.6. (WEILAND 2008, 2010)</p> $\frac{((\text{consumption B} \cdot 166) - 0.15) \cdot 500 [\text{mg L}^{-1} \text{HAc}]}{\text{consumption A} \cdot 500 [\text{mg L}^{-1} \text{CaCO}_3]}$
Volatile organic acids (VOAs)	These are steam-volatile fatty acids. The total share of volatile organic acids is indicated as acetic acid equivalent.
Waste	According to the Circular Economy Act (KrWG 2012) "waste shall mean all substances or objects which the holder discards, or intends or is required to discard".
WEENDER feed analysis	<p>The WEENDER feed analysis serves for the determination of the content of crude ash, crude fibre, crude protein, crude fat and the nitrogen-free extracts of feed. It is also applied for fermentation substrates. Based on the nutrient content, where applicable the corresponding digestibility quotients from feed(ing) value tables and the →specific methane yields (on the basis of reference substances (for i.e., the carbohydrates, crude protein and crude fat)) the approximate →methane potential of plant →substrates can be calculated.</p> <p>It is, as the →VAN-SOEST carbohydrate analysis, a convention method.</p>
Wet weight (WW)	Synonym for →fresh matter (FM)
Wobbe index	The Wobbe index is an indicator for the assessment of the combustion characteristics of a gas. The upper Wobbe index is the quotient of the calorific value and the square root of the relative gas density; the lower Wobbe index is the quotient of the heating value and the square root of the relative gas density. It is generally put in relation to the standard condition.

3 Methods for the determination of fundamental parameters

3.1 Sampling of manure (Suitability for biogas production)

Walter Stinner, Velina Denysenko, DBFZ

Status	General state of the art, but currently mostly not used in routine operation
Standard	See subchapter 3; VDI 4630 (p. 22ff), in the Fertilizers, Sampling and Analysis Ordinance (DüngMVerbV) and in the Sewage Sludge Ordinance (AbfKlärV). In addition, the instructions for "Probenahme von flüssigen Proben in Biogasanlagen" from the VDLUFA method book provide important information about proper sampling. Explanations on sampling from solid materials can also be found in the method book of the Bundesgütegemeinschaft Kompost, in the VDLUFA method books Volume II.1 „Die Untersuchung von Düngemitteln“ and Volume II.2 „Die Untersuchung von Sekundärrohstoffdüngern“.
Area of application	Biomass sampling
Disadvantage	Effort
Advantage	Standardisation of sampling and of regarding information; Enhancement of reproducible results; Possibility to correlate lab results to specific mass flow characteristics
Need for research	Built-up of database; quantification of qualitative effects

Introduction

Most biomass material flows are characterised by more or less heterogeneity. This heterogeneity is increased or decreased throughout the process chain, which is subject to the material flow. Compared to the complete mass flow, only tiny samples are analyzed in the laboratory. However, the results are used to calculate relevant quantities according to the total amount of the material. In addition, they are used in databases for projecting potentials, which are usually compared to the results of other researchers. There is repeatedly a high deviation of the results of the same sample object on different samplers or performers of the analysis. However, it is difficult to assign the deviations of the respective mass flow, to the individual sample, the location of the process chain at which the sample was taken or the sampling itself, because the corresponding boundary conditions are usually not documented.

Therefore, the representativeness of sampling is very important as well as the exact, standardised and shorthand description of the sample background, the associated process chain, the location of the sampling within the process chain and the description of de facto necessary restrictions in relation to a representative sampling. It should be noted that the evaluation of a material flow or a sample for biogas production is not limited to the methane production potential, but also includes biological, kinetic, engineering process and emission aspects. It contains also the subsequent utilization of the digestate, so that hygiene issues, as well as the content on plant nutrients and pollutants are significant.

Exsting methods

There already exist some instructions for sampling in the field of biogas and manure, e.g. within VDI 4630 (p.22ff), in the Fertilizers, Sampling and Analysis Ordinance (DüngMVPProbV) and in the Sewage Sludge Ordinance (AbfKlärV). In addition, the instructions for "Probenahme von flüssigen Proben in Biogasanlagen" from the VDLUFA method book provide important information about proper sampling. Explanations on sampling from solid materials can also be found in the method book of the Bundesgütegemeinschaft Kompost e. V (Federal Compost association), in the VDLUFA method books Volume II.1 „Die Untersuchung von Düngemitteln“, and Volume II.2 „Die Untersuchung von Sekundärrohstoffdüngern“.

However, the VDI remains very general. It lacks (i) a specification in even one exemplary case, therefore (ii) the requirement to use only very experienced staff for sampling is completely reasonable, but unfortunately does not reflect reality. Frequently, for financial reasons or for reasons of hierarchical thinking, untrained, often inexperienced staff takes samples of material in dirty surroundings like stables or manure storages. It also lacks (iii) the link to the process chain, in which significant effects on the material flow occur (see below). The effects of the process chain have, for example, an impact on the total material flow in terms of their dry matter content (DM), ammonium content (NH_4) and especially on the biogas formation potential. The methods mentioned also lack (iv) sensitization for accompanying data necessary for comparability (see next subchapter "Boundary conditions...").

Finally yet importantly, (v) there is no indication of alternative procedures or at least documentation in a sampling protocol, to what extent optimal sampling could not be carried out and how an alternative action was taken. In reality, it is rarely possible to find optimal sampling conditions. Often manure samples have to be taken, when the sampler has time and not when the farmer stirs up the tank. It is hardly ever noted that a sample mixed only by simple tools was taken instead of complete stirring of the tank. In this case it does not represent an aliquot of the storage contents. In addition, there is no recommendation in any method description on supplementary measurements concerning the depth of swimming cover, inviscid layer and sediment layer by folding stick or measuring stick as a method to conclude on the total mass flow via subsamples of the individual segments.

Therefore, the sensitization on the subject is completely necessary in the mentioned methods. However, the demand for high-experienced staff remains too general, so that the sampler is not helped and necessary accompanying information to assess the results is missing.

The Ordinance on Sampling Procedures and Methods of Analysis for the official control of fertilizers (Fertilizer Sampling and Analysis Ordinance - DüngMVProbV) refers to commercial fertilizers that are already well homogenised and does not include any aspects that are relevant to biogas production potential.

The method book of the Bundesgütegemeinschaft Kompost e. V (Federal Compost association) primarily focuses on the degree of maturity, hygiene and nutrient contents of composts and their starting materials, and not on the aspects that are important for the biogas sector. The same applies to the VDLUFA method books Volume II.1 "Die Untersuchung von Düngemitteln" and Volume II.2 "Die Untersuchung von Sekundärrohstoffdüngern".

Thus, it lacks a description of the method that describes and standardises the approach of material flows, the consideration of the effects of the process chain, the precise description of the associated boundary conditions, the actual sampling in the optimal case and alternatively the procedure under sub-optimal conditions as far as possible.

Boundary conditions for sampling and accompanying data collection for animal farmyard manure

The boundary conditions for sampling and accompanying data collection in animal farmyard manure are described using the example of cattle manure. Manure is regulated by § 5 no. 19 EEG (2009) with reference to Regulation (EC) No. 1069/2009 of the European Parliament and the European Council (Article 3 (definitions), No. 20 as "faces and/or urine of livestock, apart from farmed fish, with or without litter". The maximum DM content is defined as 15%. Especially in case of solid manure, fodder residues are often included. The following section explains which factors influence the properties of manure. This must be taken into account when sampling or as accompanying information in order to obtain and classify representative results.

Components of manure

In the bull fattening, cattle rearing and other cattle farming, deep litter as well as bedded floors and slatted floors are common. In case of young cattle, rearing cubicles with slatted floor or slider manure removal in the walkways areas are often used. Regarding dairy cattle, milking parlor and milk plant cleaning waters and/or feed residues are sometimes part of the manure depending on the stabling system. Depending on the operation, different amounts of long straw chopped, straw, straw pellets, sawdust or wood shavings, separated fermentation residues or similar substances, partly in mixture with lime or sand are used as litter for the laying boxes. However, some companies work completely without litter and exclusively with rubber mats. In order to compare these results with those of other authors, standardised information on the mentioned parameters is necessary.

Influence of race, animal category, level of performance and feeding

The composition of manure, in particular the biogas potential and the nutrient contents, strongly depend on animal category, race, performance level and feeding. In general, high animal performance is associated with good digestible feed and short passages in the digestive tract. Therefore, high specific gas yields can be expected from fresh manure from high-performing cattle.

However, there are interactions with the process chain: fresh samples from herds or groups of animals of high specific performance not only have a higher biogas production capacity but also a faster digestion/degradation. Depending on which point in the process chain the sample is taken (i.e. either fresh or only as a stored mixture from the manure storage), differences in feeding, litter etc. are pronounced or levelled. Pronouncing can happen e.g. by separation like forming of swimming layers, levelling is happening for example by quicker degradation of mass flows with higher methane potential during storage. Here as well standardised information on the aforementioned parameters is necessary in order to compare the results with those of other authors.

Process chain

The process chain generates homogenisations or separations. Both processes can be different at the different points of the process chain as well as differ in time.

The manure of dairy cattle is very well homogenised in case of a stable with solid surface and slider manure removal into a manure shaft, which is often equipped with agitator and usually equipped with a pump.

In the manure storage, the ensuing segregation takes place. Whenever possible at the specific stable in the consideration of the work safety, a representative sample should therefore be taken from the removal chute or better still from the pipeline between removal chute and the manure store. Electrical devices like stirrers etc. in each area, where people work, needs to be switched off while the sample is taken.

From a manure shaft like described above, a fresh and well-mixed sample can basically be taken at any time of the day. If, in a specific stable, milking parlor and milk plant cleaning waters and/or feed residues are part of the manure, they are usually added only at certain times of the day. Therefore, a number of samples must be taken and either mixed in a representative manner or analyzed separately and brought together in terms of results, taking into account the measured or estimated quantities.

If sampling from storage (e.g. manure heap, slurry basins, and manure storage) is necessary, it demands particular applications on the collection of representative samples and on the description of the boundary conditions. In any case, the procedure and local boundary conditions must be described in detail and standardised.

Sampling procedure

In order to increase the representativeness of each sample as well as to document possible limitations in sampling, the sample questionnaires at the end of the chapter should be used.

Dairy cattle

Slider manure removal

In barns with slider manure removal, the manure is usually pushed several times a day into a discharge chute from which it is then pumped into the storage. Feed residues are usually stored separately, but sometimes also, usually once a day pushed into the discharge chute or on the walkways. If the walkways are shoveled by vehicle, this usually occurs 1–2 times per day. The milking parlor wastewater and the rinsing water of the milking plant are partially separated, partly directed into the removal chute and then after being mixed up with the liquid manure treated further.

- It must be noted (see above), whether feed residues or milking parlor water are added to the manure.
- At different times of the day, there will be different ratio of manure, feed residues and cleaning water amounts in the discharge chute, if both streams are integrated there.
- It must be checked and noted, whether at the time of sampling feed residues or milking parlor water were part of the sample.
- If so, the ratio of the excrements to the other components needs to be estimated for the sample and for the entire daily mass-flow.
- Ideally, a manure sample is taken at a time when neither milking parlor water nor feed residues are contained. At the same time, a residual sample of feed residues should be taken by representative sampling of small amounts at different spots of the feed residues, mixing and taking the required amount for sampling. If it is afterwards possible to determine the quantities of the various partial flows of milking parlor or milking plant wastewater, feed residues and manure without the abovementioned constituents (or total amount), the composition can be merged mathematically.
- If such a determination of the subsets is not possible, samples of the different mixtures should be determined. Due to the intervals of the slider run times, the proportion of manure without feed residues and wastewater can be roughly estimated.
- If the removal chute has a homogenising stirrer, the sample is preferably removed from the chute after homogenisation. **Caution: disconnect electrical power supply to the stirrer when sampling!**
- Pure fresh manure is usually homogeneous even without agitator in the removal chute. The sample can therefore also be removed without previous homogenisation.

- If the material is inhomogeneous (e.g. with feed residues, larger litter quantities, milking parlor water) and cannot be stirred in the removal chute, check whether the sample can be taken after pumping, i.e. at the pipeline to the storage container.
- Otherwise, the inhomogeneity of the sample must be documented.

Slatted floor

In stables with slatted floor and storage of manure under the stable (for a certain period), the manure is separated into a swimming layer (in case of cattle manure particularly more distinct, possibly intensified by litter), a medium, less inviscid phase, and a sinking layer. To obtain a homogeneous sample, the liquid manure has to be stirred up. However, this demands considerable effort for the stirring itself and for the necessary safety measures. Additionally it results in further emissions into the stable. In reality, the homogenisation of the liquid manure therefore usually has to be avoided or, alternatively, the swimming cover is destroyed with simple tools (stick, shovel, etc.) and mixed with the liquid phase underneath. However, neither a representative nor a homogeneous sample is produced in this way.

- The sampling conditions should be described in the enclosed document.
- The measurement of both phases of the swimming cover the lower inviscid phase and the sink layer, the separate removal of the respective material and subsequent mixing leads to more representative samples.
- Typically, the swimming cover at the sampling spot is less thick compared to the rest of the stable, therefore preferably measure in several locations and ideally take the sample elsewhere. If this is not possible, it should be at least documented.
- Sampling from the sinking layer will generally not succeed at higher filling levels, please document in this case, that only swimming and liquid layer have been included into the sample.
- If wastewater from the milking parlor and rinsing water from the milking plant is added to the manure, it is usually discharged directly into the manure channels. Most commonly, the stable is arranged in that kind that this water is not evenly distributed on the channels. Instead, an increased water content is included in the inlet channel to the sampling point. The ratio of the sampling point to such water discharge should be considered and documented when sampling.
- For stables with slatted floor, the feed residues are deposited separately in almost all cases. If the biogas potential at the site or that of the stable system should be recorded, a representative sample of the feed residues has to be taken. For this purpose, a handful of feed residues at different points (e.g. each meter of feeding line) should be collected into a bucket etc., preferably immediately before the feed residues are pushed together, ideally from the feeding table. Afterwards it should be mixed homogeneously and the necessary sample quantity can be taken. For homogeneous feed residues (e.g. pure maize silage without top layer as feed basis), at least 20 subsets should be taken per animal group. The more inhomogeneous the feed residues are, the more individual samples have to be taken (e.g. for corn silage incl. edge and surface layers 40 subsets are required, each further feed component requires 20 subsets).

- To homogenise solid samples, a garden shredder is very well suited. However, if this option is used, the material must then be cooled, frozen, dried, or processed very quickly, as shredding loosens the material and speeds up the degradation process. The corresponding preservation method must be precisely documented.
- A documentation of the feed, the amount of feed remaining and if necessary of the condition (were the silo's marginal and top layers left over or fed?) and the sampling procedure is necessary.

Solid manure

Concerning dairy cattle, solid manure systems play no longer a significant role. If needed, see below "Other cattle".

Other cattle

Liquid manure systems

The same as described above for dairy cattle applies for liquid manure systems (slatted floor or slider removal). In case of interim cleaning and disinfection used during the inside-outside procedure, it must be documented if cleaning water is already part of the sample at the instant of sampling. Due to hygienic reasons, the inside-outside procedure is operated by many fattening farms (esp. calf or bull fattening). This means, that a business operates several separate compartments or stables, which are completely occupied at the same time, emptied in one or in a few moments in a short period, then cleaned (after rough mechanical pre-cleaning they are usually soaked with water and then cleaned by a high-pressure cleaner), disinfected and re-used after drying.

Solid manure systems

In this chapter, only deep litter systems and sloped floor systems with deep litter bedding above discussed since other tethered housing systems are only relevant for aspiring small stocks with almost no importance for the use of biogas. Internationally, stable systems without any litter are commonly used, where cattle are kept under a weather protection roof or open air on mature soil or concrete floors (Korral, Corral, Kral). The procedures described below for deep litter can be used here. The increased sediment content and possibly existing inhomogeneities due to wet and dry areas in the corral/Kral need to be considered.

Since a representative and homogeneous sampling of a manure heap on concrete slab outside the stable is seldom possible even with great effort, the sampling should be taken directly from the stable. Regarding sloped floor systems with deep litter possibly manure freshly deported from the gangway is preferred. Sampling between cattle can be dangerous, so cattle should be first fed in a detachable stable area. The access should be closed for the duration of the sampling. At least, where this is not possible, the experienced livestock keeper, who exclusively observes and controls the herd, should assist the sampler.

In a sloped floor system with deep litter the manure is usually deported from the walkway daily and put on the manure storage area. As far as possible without any risk (see above), the sample should be collected with a shovel in a bucket etc. before being pushed off several spots of the walkway. Afterwards it should be mixed homogeneously and the neces-

sary amount of sample should be taken. A fork must not be used because then the taken sample would be non-representative. It would have relatively much litter material, lower amount of feces and very low urine or liquid amount. If it is not possible or reasonable for safety reasons to remove the sample from the stable, it should be taken from the freshly dumped manure. It is important to take the sample before segregation, before the manure seeps down or runs off and before the surface dries out. Taking into account the horizontal and vertical heterogeneity of the emerging heap, it must be adequately sampled at various spots and after that homogenised (cf. above fodder residues).

In case of a deep litter stable, the least effort method is to take the sample at the time of manure removal. Taking into account the thickness and the horizontal and vertical heterogeneity, it must be adequately sampled at various locations and then homogenised (see above). Sampling in the area of moving machines is highly dangerous. Therefore, machine movements during sampling have to be omitted.

Beyond the time of manure removal, a core should be cut out vertically from the surface to the concrete floor at several points using a sharp knife. The complete material is collected in a bucket and then homogenised. The necessary amount of sample can be taken from this mixture. At the sampling spots, it should be noted that straw bales are often provided as litter in certain areas and then more or less playfully spread out autonomously by the animals themselves. The defecation behaviour also differs on the entire lying surface, in particular in relation to the feeding areas. Accordingly, the heterogeneity has to be assessed before making a representative selection of the sampling spots.

Depending on the depth and strength of the manure mattress, the use of a mechanical knife is highly recommended. Possibly the sampling core must also be cut in a pyramidal manner in order to get a representative sample.

To homogenise solid samples, a garden shredder is very helpful. However, if this option is used, the material must then be cooled, frozen, dried, or processed very quickly, as shredding loosens the material and speeds up the degradation process. The corresponding preservation method must be precisely documented.

Manure-heap

For reasons of homogeneity and representativeness of the sample, sampling directly in the barn or during manure removal is always preferable (see above). In a heap, there are changes that on the one hand increase inhomogeneities and on the other hand lead to changes from the original state.

- Particularly in case of very wet, still partially free flowing and particularly dry, pourable manure, segregation may occur even during relocation, especially when large quantities are tipped off.
- Concerning manure heaps dumped on a concrete slab, the material on the ground is usually more heavily mixed with inorganic and foreign matter, all the more when manure has been dumped on a different surface.

- The surface of a heap dries out even more (as well as covered by fleece, even though a fleece cover reduces the drying), while the material in the lower part is moistened to water-holding ability by seeping liquid.
- A humidity gradient of 20–25 % DM in the lower inner area – in extreme cases 80 % DM at the surface – can occur.
- The compression by the mass pressure leads in the lower area to a change in the pore structure, capillarity, water holding capacity, etc.
- At the surface, an N-depletion occurs by ammonia outgassing.
- Degradation processes that are aerobic in the surface area, including semi-aerobic and anaerobic in the interior, lead to altered composition over time, i.e. to reduced biogas production potential. When interpreting the values, this should be taken into regard.

If a sample has to be taken from a manure heap, the following aspects have to be considered. The heap and the possible or visible changes compared to the original state have to be noted in the enclosed document. Otherwise, the results can only be interpreted to a limited extent and the meaningfulness of the planned laboratory analysis must be called into question. Important aspects to note are especially the description of the sampling, the origin of the manure, the homogeneity of the total heap (same origin?), the storage period, the storage conditions (ground, temperature, season or date etc.), leaking or leaked liquid, abnormalities such as vapor formation or fungal growth, etc.

A note in the sampling protocol should be made with regard to the weather conditions during sampling. If possible, sunny, windy weather conditions should be avoided as it will force drying and volatilization of ammonia and organic acids. As known from application experiments, organic fertilizers can lose almost the entire ammonium nitrogen under appropriate weather conditions. Thus, the laboratory sample corresponds no longer with the starting material, but for its evaluation, the laboratory measurement values are used.

When a representative sample is taken, the area lying at the bottom of the heap is generally left out, because it usually contains a higher proportion of foreign matter. Ideally, the entire heap is mixed, e.g. by loading on a manure spreader and unloading with mixing rollers. In doing so, an aliquot is taken, depending on the total amount and heterogeneity in the range of 1–10 % of the original heap. Depending on the amount of remaining aliquot relative to the amount of sample required, mixing must be repeated by machine or by hand (by fork or shovel, depending on consistency, but mixing by fork only if no additional segregation is expected) (straw-faeces-urine relation) to yield an aliquot. To homogenise solid samples, a garden shredder is very helpful. However, if this option is used, the material must then be cooled, frozen, dried, or processed very quickly, as shredding loosens the material and speeds up the degradation process. The corresponding preservation method should be documented.

Table 3.1-1: Sampling documentation sheet:
A) Sampling of cattle manure

Basic data			
Animal type, category	Cattle, race, Type: <input type="text"/>	Dairy cows: <input type="text"/> Young cattle female (> 6 months): <input type="text"/> Rearing calves (< 6 m): <input type="text"/>	<input type="checkbox"/> Without own young cattle <input type="checkbox"/> Total young cattle reared (female + bulls)
		<input type="checkbox"/> Total female young cattle reared <input type="checkbox"/> Female young cattle partly reared; Rate: <input type="text"/> %	Fattening bulls (> 6 m): <input type="text"/> Mother cows + offspring: <input type="text"/> Other: <input type="text"/>
Performance level			
(performance level of the whole herd, if the manure accrues in one stable; performance level of the group of animals, if the manure accrues in a separate section)			
Please give special yields for your different categories of cattle (e.g. for daily weight gain give animal category and number for each category)	Milk yield (ideally FCM corrected): <input type="text"/> kg/year	Ø Age of first calving: <input type="text"/> months	
	Daily weight gain of:	<input type="text"/> g/day	<input type="text"/> g/day
		<input type="text"/> g/day	<input type="text"/> g/day
		<input type="text"/> g/day	<input type="text"/> g/day
Stable system and manure removal system:			
If information is not known as requested, please mark it differently, e.g. "Yes", "Quantity unknown". If cleaning water is added to the liquid manure, but with unknown amount, estimate the amount of water when possible.			
Type of farmyard manure	<input type="checkbox"/> Solid manure	<input type="checkbox"/> Liquid manure	
Litter quantity/animal place/day	<input type="text"/> kg		
Cleaning water for milking parlor (if added to the manure)	<input type="text"/> L/day		
Cleaning water for milking plant (if added to the manure)	<input type="text"/> L/day		
Feed residues included?	<input type="checkbox"/> NO <input type="checkbox"/> YES	If yes: quantity/animal place/day <input type="text"/> kg or <input type="text"/> % of feed amount	
Manure removal system	<input type="checkbox"/> Slatted floor, manure cellar under floor		
	<input type="checkbox"/> Additional external manure storage		
	<input type="checkbox"/> Solid floor, slider manure removal, external manure storage		
	Other (please note and describe the manure removal and storage): <input type="text"/>		

This table may be reproduced as a working table in conjunction with the following information: Stinner W. & Denysenko V. (2020): Sampling of manure (Suitability for biogas production). In: Collection of Methods for Biogas: Methods to determine parameters for analysis purposes and parameters that describe processes in the biogas sector. 47-49. ISBN: 978-3-946629-47-4.

3 Methods for the determination of fundamental parameters

Beef cattle

Inside-outside-system NO YES If yes, Fattening period: [] months

Use of cleaning detergents or disinfectants NO YES
Quantity and type: []

Is the stable cleaned with water before re-allocation and the cleaning water added to the manure?
 NO YES If yes, the amount of water: [] L

Feed

Basic feed Mainly grass silage Mainly maize silage
 Mainly clovergrass silage Grazing [] % of feed amount
Others, namely: [] Quantity/animal/day: [] kg

Concentrated feed []
(kg/animal/day)

Other feed (type and quantity per animal/day) []

Special features Nutrient-reduced feeding
 High levels of energy or protein as a rumen-stable starch or small intestine-digestible protein
 Rumen methane reduction, e.g. due to the tannin content of certain feed
Further features: []

Comments (other)

Sampling date, age of the manure, possibility of taking a representative aliquot, sampling conditions etc. (see methods description) []

B) Sampling of swine manure

Basic data and performance level

Pigs, category, resp. number of animal places Sows: [] Weaning age: [] (days)
Ø Weaned piglets/sow/year: []
Rearing piglets: [] age [] (days) to [] (days); up to [] kg
Animal losses till weaning: []
Fattening pigs: [] Duration: [] Stalling-in weight: []
Final weight: [] Ø Daily weight gain: [] Animal losses: []

Stable system and manure removal system:

If information is not known as requested, please mark it differently, e.g. "YES", "Quantity unknown".
If cleaning water is added to the liquid manure, but with unknown amount, estimate the amount of water when possible.

Stable Closed Isolated, heated Stable temperature: _____

Air supply Open, open-air Air insufflation at top Air extraction underneath floor
 Other: _____

Type of farmyard manure Solid manure Liquid manure Solid-liquid combination
 Other: _____

Manure removal system Slatted floor, manure cellar under floor Additional external manure storage
Storage time in cellar: _____

Solid floor, rinsing with water, external manure storage
Water amount /day: _____ L

Solid floor, liquid manure drain, slider manure removal for feces

Solid manure (system description incl. litter quantity etc.): _____

Other (please note and describe the manure removal and storage): _____

Cleaning water (if added to the manure): _____ L/passage

cleaning detergents or disinfectants: _____ type (s) quantity/passage _____ kg L⁻¹ (delete if appropriate)

Feed supplement/minerals _____ type (s) quantity/animal place/passage _____ g

Medication _____ type (s) quantity/animal place/passage _____ g
 Feed supplement Injection Combination or other: _____

Feed

Compound feed resp. single feed (type, content, quantity/animal/day) Consistent compound feed during whole fattening period
Energy content: _____
Protein content: _____ quantity/animal place/day : _____ kg
 Different compound feed and single feed in different fattening periods, namely (resp. fattening period, type and quantity/animal place/day): _____

Special features Nutrient-reduced feeding N-reduced P-reduced

Further features: _____

Comments (other)

Sampling date, age of the manure, possibility of taking a representative aliquot, sampling conditions etc. (see methods description) _____

3.2 Determination of total solids (dry matter) and volatile solids (organic dry matter)

Katrin Strach, DBFZ

Status	Is being used in routine operation.
Standard	The determination of total solids and of volatile solids is modelled after DIN EN 15935 (2012–11) and/or DIN EN 15935 (2012–11)
Area of application	Substrates and digestates in which only a small share of volatile components is to be expected.
Disadvantage	In addition to water, other volatile components (e.g. volatile organic acids) are also driven out.

Devices and chemicals

- muffle furnace
- drying cabinet
- precision scale
- desiccator

Execution method

To determine the total solids (TS) of liquid samples, e.g. digestates, the empty weight of the crucible is recorded first. Then, approx. 5 g of the sample are filled into the crucible and the weight of the filled crucible is once again entered into the log. For drying, the filled crucibles are placed in the drying cabinet at 105 °C. The crucibles are left to dry until a constant weight is achieved. The constant weight of the crucible with the dried sample is recorded. Subsequently, the samples are calcined in the muffle furnace at first for 30 min at 220 °C, and then for 2 h at 550 °C. After the calcination, the hot crucibles are cooled down in desiccators. After the cooling down of the crucibles, these are weighed once again.

Calculation of the total solids content

$$TS = 100 \cdot \frac{m_3 - m_1}{m_2 - m_1} \quad \mathbf{01}$$

TS	Total solids content (also referred as dry matter)	%
m_1	Mass of the empty crucible	g
m_2	Mass of the crucible after the sample was added	g
m_3	Mass of the crucible after drying	g

Calculation of the volatile solids

$$VS = 100 \cdot \frac{m_3 - m_4}{m_2 - m_1} \quad \mathbf{02}$$

VS	Volatile solids content	% _{TS}
m ₁	Mass of the empty crucible	g
m ₂	Mass of the crucible after the sample was added	g
m ₃	Mass of the crucible after drying	g
m ₄	Mass of the crucible after calcination	g

To determine the total solids of inhomogeneous substances such as silages, grass or manure, a larger weighed-in quantity of 200 to 250 g, in shallow pans, is used. It will be dried and the masses recorded, as described above. In order to determine the volatile solids, the dried sample is ground to ≤ 1 mm. Subsequently, a representative sample is taken. Based on this sample, the TS/VS determination is carried out, as described.

3.3 Total solids content correction according to WEISSBACH & STRUBELT

Britt Schumacher, DBFZ

<p>Status</p>	<p>The method for the correction of the total solids content of silages by volatile organic acids and alcohols was suggested by WEISSBACH & STRUBELT (2008a, 2008b, 2008c), based on earlier research tests in the area of feed(stuffs) evaluation (WEISSBACH & KUHLA 1995) as well as current studies for the biogas sector. Research tests by (MUKENGELE & OECHSNER 2007) showed an overestimation of the specific methane yield by up to 10% for maize silage, if no correction for volatile substances was carried out.</p> <p>In the currently applicable version of VDI GUIDELINE 4630 (2016), which is currently undergoing a revision, a correction for the volatile acids is being recommended (determination in accordance with (DIN 38414-19 1999)), wherein 10,000 mg L⁻¹ acetic acid equivalent concentration corresponds to an VS increase by 1% absolute relative to wet mass. Alcohols are not being taken into consideration, here.</p> <p>The concentrations of volatile components required for the correction can be determined by means of GC (gas chromatography) and additional lactic acid analytics or HPLC (high-pressure liquid chromatography), c.f. Ch. 4.1 and 4.2. It is important that the methods for the testing of green crop silages be adjusted to the substance concentrations which are considerably higher, here, than in the digester content and/or in digestate. To be determined are the lower fatty acids of carbon chain length C2 to C6 (including the iso acids), the alcohols of carbon chain length C1 to C4 (including 1,2-propanediol and 2,3-butanediol) as well as the lactic acid (WEISSBACH 2011). Since the fermentation acid patterns and alcohol patterns are strongly dependent on the silaging conditions, a determination of the concentration must be performed for each dry solid content correction (BAHNE-MANN 2012).</p>
<p>Associated standard</p>	<p>None known.</p>
<p>Area of application</p>	<p>In the case of the method introduced in Ch. 3.1. "Determination of total solids and of organic dry matter", volatile substances such as organic acids and alcohols that may, for example, be contained in silages in not insignificant amounts, are not taken into consideration. This can lead to an underestimation of the total solids content and thereby to an overestimation of the biogas yield and/or the biogas (formation) potential (VDI Guideline 4630 2016) and may make the comparison of substrates amongst one another more difficult. For this reason, Weissbach & Strubelt published an article in "Landtechnik" (Agricultural Engineering) magazine regarding the correction of the total solids content of maize silages (WEISSBACH & STRUBELT 2008b), grass silages (WEISSBACH & STRUBELT 2008a) and sugar-beet silages (WEISSBACH & STRUBELT 2008c).</p>

Area of application

The authors BERG & WEISSBACH (1976) investigated the concentrations of potentially volatile substances in a representative collection of samples from maize, grass and sugar-beet silages as well as in the drying residues generated therefrom upon determination of the TS content. From the comparison of the concentrations measured in the fresh and the dried sample, conclusions were drawn regarding the rate of volatility of the respective compound. Only in the case of lactic acid, this approach could not be used due to the condensation reactions (lactone formation) which the lactate is subject to during the drying. Here, the rate of steam evaporation volatility of lactic acid determined in earlier tests by means of dry distillation of silage samples was incorporated (BERG & WEISSBACH 1976).

For the tests, water extracts were used that corresponded to a ratio of 50 g of fresh silage per 200 mL of water, each. In these extracts, both the lower fatty acids as well as the alcohols were determined through gas chromatography with a GC/FID device system (Shimadzu) with capillary columns and internal standards (iso-caproic acid for the acids, and pentanol for the alcohols). To determine the lower fatty acids, formic acid was added to the extract to release them. Prior to the determination of the alcohols, the fermentation acids in the extracts were neutralised with sodium hydroxide. In parallel to the GC, the pH values and the lactic acid contents in the extracts were measured.

The determination of the lactic acid was performed by means of the colorimetric method according to Barker & Summerson (1941) with 4-biphenylol, modelled after the version described by HAACKER, BLOCK & WEISSBACH (1983). All these methods are in-house methods of the "Analytics Laboratory for Agriculture and Environment" (Analytiklabors für Landwirtschaft und Umwelt) Bllgg Deutschland GmbH (Lübzer Chaussee 12, D-19370 Parchim) and conform to the standard of certified laboratories of this subject area (STRUBELT 2013).

An overview of the range of the total solids contents as well as of the shares of potentially volatile substances overall (sum of lower fatty acids, lactic acid and alcohols) in silages that were tested by the authors and utilised to derive the volatility factors, is provided in Tab. 3.3-1.

The information shows that in the case of silages – in comparison to the source material from which they were manufactured – a portion of the TS and/or the VS consists of potentially volatile fermentation products that are not captured in the typical determination of TS and VS (Ch. 3.1). The share of these fermentation products may differ widely, depending on the type of crop, the variety, the location, the weather, and the diligence upon ensiling. It may reach a significant scope. The individual substances are volatile to different degrees. Therefore, determining them and including them in the assessment of the substrates by means of a correction of the TS content is an urgent necessity.

Need for research	<p>The coefficients for acids and alcohols suggested by WEISSBACH and STRUBELT can be understood as volatility factors upon drying at 105 °C. The degree of volatility depends on the temperature and on the vapour pressure of the substances. Since no systematic investigation of the volatility is apparent from the publications to date, a verification of the suggested factors should be performed, in particular with respect to different drying temperatures and durations and the different drying behaviour resulting therefrom (BANEMANN 2012).</p> <p>In addition to silages, it is also conceivable that residues from food production or from other branches of industry may contain volatile substances and that therefore a total solids content correction would be sensible here, too. This would need to be researched separately for each substrate, based on a representative sample selection in accordance with the approach described by WEISSBACH & STRUBELT.</p> <p>Alternatively, in the case of substrates with only a low water content and a high share of volatile substances, the Karl Fischer method could be utilised to determine the water content of a substrate and thereby its total solids content including volatile components. From this, the ash content can be subtracted to determine a corrected VS content. In the opinion of (WEISSBACH 2011), the Karl Fischer method provide values for the TS content then calculated as difference that are too inaccurate due to its comparatively high water content.</p>
--------------------------	---

Table 3.3-1: Bandwidth of the uncorrected total solids as well as the sum of the potentially volatile fermentation acids and alcohols (WEISSBACH & STRUBELT 2008a, 2008b, 2008c)

Substrate	Uncorrected total solids content in g kg ⁻¹ FM			Fermentation acids & alcohols in g kg ⁻¹ FM		
	Minimum value	Maximum value	Average value	Minimum value	Maximum value	Average value
Maize silage	224	492	337	12	49	33
Grass silage	179	597	428	7	61	30
Sugar-beet silage	88	207	154	6	124	94

Description of method

WEISSBACH & STRUBELT suggest improved correction equations based on the determination of the total solids content (also referred to as dry matter), the lower fatty acids (Ch. 3.1 and 3.2), the lactic acid (Ch. 3.2), the alcohols, and – in part – also the pH value. In deviation from Ch. 3.1, the determination of the total solids content is performed according to WEISSBACH. As is typical in the case of feed tests, first, a pre-drying at 60 to 65 °C takes place and subsequently a final drying of exactly three hours at 105 °C to determine the total solids content (TS content).

(WEISSBACH & STRUBELT 2008b) recommend the following correction of the TS content for **maize silages**, wherein all data have to be filled-in in g per kg FM:

Calculation of correction of the TS content of maize silages

$$TS_c = TS_n + 0.95 \text{ LFA} + 0.08 \text{ LA} + 0.77 \text{ PD} + 1.00 \text{ OA}$$

03

TS_c	Corrected TS content of maize silages	$\text{g kg}^{-1} \text{FM}$
TS_n	TS content of maize silages	
LFA	Sum total of the contents of lower fatty acids (C_2-C_6)	
LA	Lactic acid content	
PD	1,2-propanediol content	
OA	Sum total of the contents of other alcohols (C_2-C_4 , including 2,3-butandiol)	

All information that is relative to TS_n , such as the ash content, must be corrected after TS_c is calculated through multiplication with the quotient of TS_n/TS_c (WEISSBACH & STRUBELT 2008a). The amount of the volatile solids content (VS) is the result of the difference between the corrected total solids content and the corrected ash content. The correction formula for maize may also be applied in the case of sorghum and grain crop silages as an approximated solution (WEISSBACH 2011).

Based on tests of their own, (WEISSBACH & STRUBELT 2008a) specify the following formula for the correction of the TS of **grass silage**:

Calculation of correction of the TS content of grass silages

$$TS_c = TS_n + (1.05 - 0.059 \text{ pH}) \text{ LFA} + 0.08 \text{ LA} + 0.77 \text{ PD} + 0.87 \text{ BD} + 1.00 \text{ OA}$$

04

TS_c	Corrected TS content of grass silages	$\text{g kg}^{-1} \text{FM}$
TS_n	TS content of grass silages	
pH	pH value	
LFA	Sum total of the contents of lower fatty acids (C_2-C_6)	
LA	Lactic acid content	
PD	1,2-propanediol content	
BD	2,3-butandiol content	
OA	Sum total of the contents of other alcohols (C_2-C_4)	

The correction formula for grass silage may also be used for clover, grass ley, alfalfa and green grain silages (WEISSBACH 2011).

Another correction formula was developed for **sugar-beet silages** (WEISSBACH & STRUBELT 2008c):

Calculation of correction of the TS content of sugar-beet

$$TS_c = TS_n + 0.95 \text{ LFA} + 0.08 \text{ LA} + 1.00 \text{ AL}$$

05

TS_c	Corrected TS content of sugar-beet silages	$\text{g kg}^{-1} \text{FM}$
TS_n	TS content of sugar-beet silages	
LFA	Sum total of the contents of lower fatty acids (C_2-C_6)	
LA	Lactic acid content	
AL	Sum total of the contents of all alcohols (C_1-C_4 , including the diols)	

Here, the volatility rate was only estimated based on the results for other silages and was not measured since the relatively high content of soluble pectin substances would make the GC measurements in the drying residue impossible. According to (WEISSBACH 2011), the application of the correction formula for sugar-beet silages with higher TS contents than those of the samples tested by him is possible without a problem; this also applies to silage effluent. In the case of grass and sugar-beet silage, the correction of the ash content and the VS is carried out analogously to the approach for maize silage (WEISSBACH & STRUBELT 2008a, 2008b, 2008c).

3.4 Determination of the VOA value (according to Kapp) and of the VOA/buffer capacity value (in accordance with FAL)

Katrin Strach, Michael-Dittrich Zechendorf, DBFZ

Status	Are being used in routine operation.
Standard	VOA according to Kapp (BUCHAUER 1998) VOA/buffer capacity in accordance with FAL (BURCHARD et al. 2001)
Area of application	Can be used for digestates and liquid substrates in which the liquid phase can be separated off by means of centrifugation. Prerequisite is a pH value > 5.
Disadvantage	Substances with pH values below 5 cannot be analysed. Solids have a disruptive impact on the pH measurement.
Advantage	In comparison to cuvette tests, this method is very cost-efficient.
Need for research	In order to be able to, for instance, also measure digestates from hydrolysis containers, it must be possible to also make a determination for sample with pH values below pH = 5. It has to be researched whether it is possible to raise the pH value prior to titration or whether, for example, steam distillation would constitute a suitable method.

The determination of the VOC according to Kapp and of the VOA/buffer capacity in accordance with FAL are, from a technical point of view, two different methods which can be carried out in a single, joint work step. Fundamentally, in both cases, the clear phase of a centrifuged sample is titrated in stages to certain pH values by means of sulphuric acid. Both processes are carried out in a single work step and the titration is performed for all individual stages; subsequently, the amounts of sulphuric acid used are calculated, depending on the method.

By means of the **method according to KAPP**, the concentration of the volatile organic acids (VOAs) is determined through titration. The clear phase of a sample is titrated with the automatic titration machine Mettler Toledo type Rondo 60/T90 with 0.2 N sulphuric acid in stages up to the pH values 5, 4.4, 4.3 and 4.0. With the acid consumption achieved, the VOA value can be calculated (BUCHAUER 1998).

Devices and chemicals

- titrator or burette with pH-meter
- centrifuge
- beaker
- pipette

The calculation of the concentration of the acids is carried out in accordance with the following formula:

$$\text{VOA} = 131\,340 \cdot (V_{\text{pH}4.00} - V_{\text{pH}5.00}) \cdot \frac{N_{\text{H}_2\text{SO}_4}}{V_{\text{sample}}} - 3.08 \cdot V_{\text{pH}4.30} \cdot \frac{K_{\text{S}4.3} [\text{mmol/L}]}{V_{\text{sample}}} \cdot \frac{N_{\text{H}_2\text{SO}_4}}{V_{\text{sample}}} \cdot 1000 - 10.9 \quad \mathbf{06}$$

VOA	Concentration of the volatile organic acids according to Kapp	mg L ⁻¹
V _{pH4.00}	Volume of acid titrated in up to pH = 4.00	mL
V _{pH4.30}	Volume of acid titrated in up to pH = 4.30	mL
V _{pH5.00}	Volume of acid titrated in up to pH = 5.00	mL
V _{sample}	Volume of centrifuged sample submitted	mL
N _{H₂SO₄}	Normality of the acid (molar concentration of hydronium-ions of the acid)	mol L ⁻¹
K _{S_{4.3}}	Alkalinity 4.3 [mmol L ⁻¹] (DIN 38409-7 2005)	mmol L ⁻¹

Area of validity

- Acids from 0 to 70 mmol L⁻¹ (0 to 4,203 mg_{HAc} L⁻¹)
- NH₄⁺-N from 400 to 10,000 mg L⁻¹

The determination of the **VOA/buffer capacity** in accordance with FAL is carried out through titration of the clear phase of a sample with the pH values up to 5.0 and 4.4. Subsequently an assessment is performed via the following equation:

$$\text{VOA/TIC} = \frac{\left((V_{\text{pH}4.4} - V_{\text{pH}5.0}) \cdot \frac{20}{V_{\text{sample}}} \cdot \frac{N_{\text{acid}}}{0.1} \cdot 1.66 - 0.5 \right) \cdot 500 \cdot V_{\text{sample}}}{0.5 \cdot N_{\text{acid}} \cdot V_{\text{pH}5.0} \cdot M_{\text{CaCO}_3} \cdot 1000} \quad \mathbf{07}$$

VOA/ buffer capacity	Relationship of volatile organic acids and the reactor buffer capacity relative to calcium carbonate	g _{VOA} /g _{CaCO₃}
V _{pH4.4}	Volume of acid titrated in up to pH = 4.40	mL
V _{pH5.0}	Volume of acid titrated in up to pH = 5.00	mL
V _{sample}	Volume of centrifuged sample submitted	mL
N _{acid}	Normality of the acid (molar concentration of hydronium-ions of the acid)	mol L ⁻¹
M _{CaCO₃}	Molar mass of calcium carbonate with 100 g mol ⁻¹	

Execution method

The sample is centrifuged at $10,000 \times g$, 10°C for 10 min. For analysis, 10 mL of the clear phase created this way is pipetted off and transferred to the automatic titration machine by means of a sample beaker. Depending on the result to be expected, the drop size of the amount of 0.2 N sulphuric acid added must be set such that the respective pH values are not exceeded. Then, the titration is started and a titration up to the pH values of 5.0, 4.4, 4.3, and 4.0 is performed one after another. The respective acid consumptions are recorded. The calculation of the respective VOA according to Kapp and/or the VOA/buffer capacity in accordance with FAL is performed as described above.

Comment: There is no direct link between VOA/buffer capacity in accordance with FAL and VOA according to Kapp. Due to the different VOA approaches, a calculation of the VOA/buffer capacity by means of VOA according to Kapp is not possible.

3.5 Determination of the ammonia nitrogen content

Katrin Strach, DBFZ

Status	Is being used in routine operation.
Standard	HACH, DR 2000 spectrophotometer handbook
Area of application	Can be used for digestates and liquid substrates in which a liquid phase is created by means of centrifugation.
Disadvantage	For samples with strong inherent colouring, a photometric determination is not always possible. For samples with a pH value < 6, the pH value must be raised to pH value 6–7. Waste is generated that must be disposed of separately. The use of the reagents of the Hach Lange GmbH company is mandatory.
Advantage	This is a quick and easy method.

The determination of the total ammonia nitrogen content (TAN) is performed according to the principle of Nessler. In this, the Nessler's reagent alkaline potassium tetraiodomercurate(II), $K_2[HgI_4]$ is being utilised. With ammonia, it builds a reddish-brown colour complex $[Hg_2N]I$, the iodide of the cation of the Millon's base. With the help of this complex, the ammonia can be determined photometrically.

Devices and chemicals

- photometer Hach DR 2000 or Hach DR 3900
- clear phase (centrifugate) of the sample after centrifugation
- mineral stabiliser (HACH LANGE GmbH)
- polyvinyl alcohol (HACH LANGE GmbH)
- Nessler's reagent (HACH LANGE GmbH)

Execution method

Prior to the determination of the ammonia nitrogen, the sample must be centrifuged for 10 min at 10 °C at 10,000 × g. From the centrifugate (clear phase), a dilution corresponding to the measuring range of the photometer is prepared (differs from system to system [most often 1:1,000 or 1:2,000]). Subsequently, 25 mL of the dilution are placed in a cuvette. In addition to the preparation of the sample, a reference (25 mL aqua dist.) must be prepared. Next, three drops of mineral stabiliser and three drops of polyvinyl alcohol are added. Shortly before the measurement, 1 mL of Nessler's reagent is added. An intermixing is achieved by carefully swirling the samples around. After a reaction time of the Nessler's reagent of one minute, the sample can be measured. Once the Nessler's reagent has been added, the samples must be measured within 5 min.

3.6 Prediction of process failures by determining the early warning indicators A/elCon, EWI-VFA/Ca and EWI-P/Ca

Patrick Schröder¹, Anne Kleyböcker², Hilke Würdemann³

¹Hochschule Merseburg University of Applied Sciences

²Kompetenzzentrum Wasser Berlin gGmbH

³Helmholtz Centre Potsdam German Research Centre for Geosciences - GFZ

Status	A/elCon, EWI-VFA/Ca and EWI-P/Ca indicators are fully applicable as well as easy and cheap in use directly on-site.
Standard	A/elCon, EWI-VFA/Ca and EWI-P/Ca have been patented (DE102018105035B3, DE102008044204B4, DE102012107410B4).
Area of application	A/elCon was successfully tested for the fermentation of renewable raw materials with and without co-digestion of lipids. EWI-VFA/Ca and EWI-P/Ca were successfully tested for the digestion of wastes from the food industry as well as for the co-digestion of sewage sludge or renewable raw materials with lipid-rich co-substrates like vegetable oil or grease from fat separators.
Need for research	Development of a measuring probe for online monitoring and analysis

Anaerobic digestion processes for the production of biogas are sensitive to changes in process control and therefore prone to process disturbances. For a more demand-driven and more flexible biogas production with respect to the substrate spectrum, sensitive monitoring systems are necessary in the future. This is why the early warning indicators (EWIs) A/elCon, EWI-VFA/Ca and EWI-P/Ca have been developed. In case of their regular application, imminent process disruptions can be recognized at an early stage. By initiating appropriate countermeasures, over-acidification of the process can be avoided. Thus, the risk of financial losses for the plant operator can be reduced. Furthermore, the process can be driven closer to its production maximum.

EWI A/elCon - Prediction of process disturbances in agricultural biogas plants

The EWI A/elCon is the ratio of the organic acid concentration and electrical conductivity arisen from the fermentation sludge. It was developed to predict process disturbances (e.g. over-acidifications) in biogas plants digesting typical agricultural substrates (SCHRÖDER 2018) and it will be measurable online in the near future. Several laboratory experiments fermenting typical agricultural substrates, such as maize silage and cattle manure, were conducted. It was observed that the electrical conductivity of the sludge was linearly dependent on the total buffering capacity, especially on the carbonate buffer, between pH 6.5 and 8. A stable biogas process is characterised by a pH between 7 and 8. In this range, the inorganic carbon mainly occurs as bicarbonate and has a high proportion on the overall

electrical conductivity in agricultural fermentation sludge. With increasing process instability, the organic acid concentration increases and the alkalinity is consumed. Thereby the equilibrium of the buffer shifts to the reaction products carbon dioxide and water. The electrical conductivity decreases as soon as the bicarbonate concentration declines. The increasing organic acid concentration and the decreasing electrical conductivity lead to an increase in the A/eICon. A 1.5-fold increase in the A/eICon in comparison to the 10-day average indicates an imminent process disturbance. In addition to a series of lab-scale experiments the A/eICon has been also tested in a full-scale biogas plant fermenting maize silage, cattle manure and dry chicken manure at an organic loading rate (OLR) of $4 \text{ kg}_{\text{VS}} \text{ m}^{-3} \text{ d}^{-1}$. A distinct warning signal has been recorded already two days after the OLR has been increased by only 6%. This correlated with a decrease in the energy yield confirming the upcoming process failure. In all experiments (12 lab-scale and one full-scale), the A/eICon warned more sensitive of upcoming process disturbances than standard parameters like VOA/buffer capacity (FOS/TAC), pH and methane yield. If high proportions of ammonium-rich substrates were fermented (e.g. turkey manure), the A/eICon warned as early as the VOA/buffer capacity. Perhaps ammonium contributed strongly to the overall electrical conductivity resulting in a decreased sensitivity of the A/eICon.

EWI-VFA/Ca and EWI-P/Ca - Prediction of process disturbances in biogas plants co-digesting lipid-rich substrates

The early warning indicators EWI-VFA/Ca and EWI-P/Ca have been developed for the prediction of process disturbances in biogas plants co-digesting lipid-rich substrates, such as in the fermentation of leftovers from the food industry or sewage sludge together with grease from fat separators (KLEYBÖCKER et al. 2012).

The EWI-VFA/Ca is defined as the ratio of the volatile fatty acid (VFA) concentration to the calcium concentration (Ca). In the course of an upcoming process disturbance, the organic acid concentration increases. In addition to VFA, also the concentration of long-chain fatty acids increases in the course of a process imbalance if lipid-rich substrates are co-digested. Long-chain fatty acids precipitate with calcium ions, leading to a decrease in the calcium concentration. The increase in the organic acid concentration and decrease in the calcium concentration lead to an increase in the EWI-VFA/Ca. A doubling in the EWI VFA/Ca value indicates an upcoming process disturbance reliably.

The EWI-P/Ca is the ratio of the phosphate (P) and calcium concentration. Sewage sludge from waste water treatment plants with biological phosphate removal contains comparably high amounts of phosphate accumulating organisms (PAOs) storing poly-phosphate. In the course of an upcoming process disturbance with increasing concentrations of VFAs, PAOs release phosphate leading to an increase in the phosphate concentration in the fermentation sludge. Furthermore, different inorganic phosphate compounds in the fermentation sludge are highly sensitive to pH changes. Already a slight decrease in the pH can lead to an increase in the phosphate concentration. The increase in the phosphate concentration and decrease in the calcium concentration (see EWI-VFA/Ca) lead to an increase in the EWI-P/Ca. A 1.5-fold increase in the value of the EWI-P/Ca indicates reliably a process imbalance.

Determination of the A/elCon, EWI-VFA/Ca and EWI-P/Ca

Materials

- centrifuge (e.g. Eppendorf Centrifuge 5804)
- conductometer (e.g. WTW Cond 3310 SET1, Xylem Analytics)
- consumables (pipettes and tips, centrifuge tubes, sample tubes, distilled water)
- heating block for cuvettes (e.g. DRB 200, Hach)
- photometer (e.g. DR2800 Photometer, Hach)
- photometrical cuvette tests for organic acids, calcium and ortho-phosphate e.g. LCK365, LCK,327, LCK350, Hach)

Analysis

After adequate mixing of the digestate in the biogas reactor, a sample of the digestate is taken. The electrical conductivity is measured by the conductometer. Approximately 80 g of the sludge sample are centrifuged for 10 min at about 13,000 g. The supernatant is centrifuged again under the same conditions and the second supernatant is used for further analysis. The concentrations of organic acids, calcium and ortho-phosphate are determined photometrically via cuvette tests according to the manufactures guidelines. Depending on the type of fermentation, the supernatant has to be diluted with distilled water in order to be within the measurement range of the cuvette tests (e.g. 1:10 dilution). In principal, also other measurement techniques are possible to determine the organic acid, calcium and ortho-phosphate concentration.

Calculation

Finally the EWIs are calculated:

$$A/elCon = \frac{\text{Organic acids [mg/L]}}{\text{Electrical conductivity [mS/cm]}} \quad \mathbf{08}$$

$$EWI - VFA/Ca = \frac{\text{Organic acids [mg/L]}}{\text{Calcium [mg/L]}} \quad \mathbf{09}$$

$$EWI - P/Ca = \frac{\text{Phosphate [mg/L]}}{\text{Calcium [mg/L]}} \quad \mathbf{10}$$

The respective values should be measured daily, when changes in the process conditions occur (e.g. during an increase in the OLR). An increase in the value of the A/elCon and EWI-P/Ca by 50 % or a doubling in the value of the EWI VFA/Ca in comparison to the 10-day average indicates process imbalances. To avoid over-acidification, countermeasures should be initiated.

4 Methods for the determination of chemical parameters

4.1 Determination of aliphatic, organic acids and benzaldehyde with headspace GC

Martin Apelt, DBFZ

The method described serves for the determination of the following organic acids: Acetic acid, propionic acid, isobutyric acid, butanoic acid, isovaleric acid, valerianic acid and hexanoic acid as well as benzaldehyde.

The headspace GC utilised is particularly suitable for the determination of the content of volatile substances in samples with a complex matrix. To address the impact of the different matrixes, the addition of 2-ethyl-butyric acid as an internal standard is performed. Through the addition of phosphoric acid to the sample, the acids are transitioned into their undissociated form and put into a highly volatile state. This way, the GC determination of the content of the aforementioned acids is possible.

With the help of a GC-MS, it was possible to unambiguously identify benzaldehyde as a component in a lot of samples, whereupon a routine detection of the substance was implemented.

Status	This is a not yet validated in-house method of the DBFZ. Varying and changing matrixes require a constant adjustment of the temperature gradient.
Associated standards	(WANG et.al 2009); (GÖRTZ & MEISSAUER 2003); (CRUWYS et.al 2002); GC Application ID No.: 15883 Phenomenex
Area of application of the method	Due to the determination by means of headspace GC, it is possible to test a lot of different matrixes. At the DBFZ, the determination of the volatile organic acids C ₂ -C ₆ is performed in order to monitor the different fermentation procedures in the area of biogas research and in order to monitor biogas plants already in operation.
Substrates/materials	Testing of digestates from the area of biogas research
Limitations of the method	The device is calibrated by manufacturing different calibration solutions for the ranges of concentration (c.f. Tab. 4.1-1). Due to the large calibrating/measurement range, it is possible to analyse virtually all samples without dilution. Since the measurement methods is not linear over the whole calibration range, two calibration functions for different ranges of concentration are prepared which overlap in their concentration ranges. This way, an exact determination is achieved for the calibration ranges stated in Tab. 4.1-1. In the lower limit of detection range, larger fluctuations of the results may occur due to inhomogeneity of samples and matrix effects.

Advantages	Easy preparation of samples and analytical measurement, which can be applied well for in-process controls with a high throughput of samples. A low use of additional chemicals for the preparation of samples has a positive effect on the cost efficiency of this method. Due to the short time required for analysis for the method described here, a close monitoring of research tests is ensured and is quite universally usable.
Need for research	To identify process disruptions in biogas plants and fermentation tests more quickly, it will be necessary in the future to identify and quantify additional analytes in the digestates. While important indicators for the progress of a fermentation are determined through the determination of the volatile organic acids C ₂ -C ₆ , an expansion of the spectrum of analytes would be helpful in order to increase the biogas yield and to identify problems early on. Worth mentioning as progress in the recent past is the identification of a recurring peak, which was identified as benzaldehyde. Now it's possible to detect them routinely in addition to the acid spectrum with the same method. To what extent an impact on the different fermentation procedures exists here still needs to be researched.

Reagents

- internal standard (ISTD): 184 mg L⁻¹
- H₃PO₄ (diluted 1:4)

Devices and aids

- 20 mL Headspace vial
- caps
- (electric) crimping tool
- 5 mL pipette
- 1 mL pipette

Sample preparation

The GC analysis is carried out as a triplicate determination. Therefore, 3 Headspace vials are prepared per sample. Prior to the determination, the sample must be centrifuged for 10min at 10 °C and 10,000 rpm.

If necessary, subsequent to centrifuging, the sample is strained through a sieve (mesh width approx. 1 mm) in order to remove coarse matrix components.

In principle, a dilution of the samples is possible, however, attention always has to be paid to the fact that the concentrations of the analytes to be determined be within the calibrated ranges of the measurement method.

Of the sample now at hand, 5 mL, each, are pipetted into a Headspace vial. Then, 1 mL ISTD and 1 mL H_3PO_4 (diluted 1:4) are added. Once the phosphoric acid has been added, the vials must be closed immediately with suitable caps and an electric crimper.

Calibration

The device is calibrated by manufacturing different calibration solutions in the following ranges of concentration:

Table 4.1-1: The calibration utilised

Analyte	Calibration range [mg L ⁻¹]	Retention time [min]	LOD [mg L ⁻¹]	LOQ [mg L ⁻¹]
Acetic acid	5.223–15669.00	6.0	2.82	8.41
Propionic acid	1.980–5940.00	7.2	1.07	3.19
Isobutyric acid	0.948–2844.00	7.7	0.37	1.18
Butanoic acid	1.920–5760.00	9.0	0.85	2.49
Isovaleric acid	0.930–2790.00	10.1	0.39	1.22
Valerianic acid	0.940–2820.00	12.6	0.63	2.02
Hexanoic acid	0.465–1395.00	15.5	0.21	0.62
2-ethyl-butyric acid (ISTD)	–	13.5	–	–

Analysis

For the calculation of the actual concentrations of the substances to be investigated, the internal standard is referenced and analysed via calibration lines.

Device parameters

Table 4.1-2: Description of the gas chromatograph (Agilent 7980A)

Injector	-	Split/splitless		
Detector	-	FID		
Carrier gas	-	Nitrogen		
Column designation	-	ZB-FFAP (Phenomenex) or equivalent		
Column length	m	30		
Column diameter	mm	0.32		
Film thickness	µm	0.25		
Flow Constant flow	mL min ⁻¹	Total flow: 8.5 Septum purge flow: 3 Split flow: 0.5		
Column temperature programme		Rate [°C min ⁻¹]	Target temperature [°C]	Duration of stay [min]
		Start 10 30 120	40 100 150 240	0 8 1 2
Measuring time	min	19.417		
Split ratio	-	0.1:1		
Injector temperature	°C	220 °C		
Detector settings	Heating H ₂ flow Air flow Make up flow Signal	260 °C 45 mL min ⁻¹ 400 mL min ⁻¹ 25 mL min ⁻¹ 10 Hz 0.02 min ⁻¹		

Table 4.1-3: Description of the headspace sample injector (PerkinElmer Turbo Matrix 110)

Temperatures [°C]	Needle	95
	Transfer line	110
	Oven	85
Pressures [psi]	Carrier gas flow	32.0
	Vial	32.0
Times [min]	Pressure build-up	4.0
	Injection	0.10
	Stay	0.5
	Thermostat	32.0
	Cycle	22.0
	PII	24.0
Additional settings	High pressure injection	On
	Vial vent	On
	Shaker	On
	Injection method	Time
	Operating method	Constant
	Injections	1
Transfer line	–	Deactivated ID: 0.32 mm

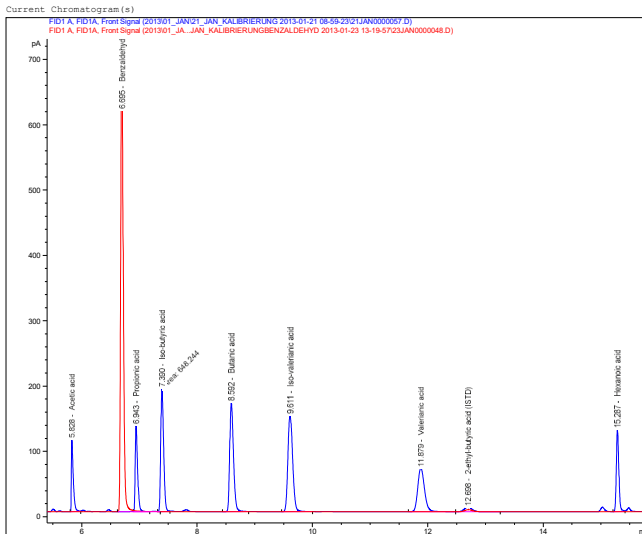
Figure 4.1-1: Sample chromatogram of a standard solution mixture (C₂-C₆) and a single standard of benzaldehyde

4.2 Determination of organic acids

Lucie Moeller, UFZ; Kati Görsch, DBFZ; Dietmar Ramhold, ISF Schaumann Forschung mbH; Erich Kielhorn, TU Berlin

Status	The determination of organic acids via ion chromatography and HPLC corresponds to the general standard.
Associated standards	GC
Area of application of the method	Substrates/materials: no restriction
Measuring range	1–1,000 mg L ⁻¹
Disadvantages	The sample must be pretreated so that it is free from suspended and humic matter. Pretreatment with the help of the Carrez clarification may be necessary.
Need for research	For these methods, there is no need for research.

Whether or not a disruption of the biocenosis in the biogas reactor exists can be identified through the determination of the volatile organic acids (acetic acid, propionic acid, butyric acid, valeric acid, etc.). These compounds occur upon the decomposition of organic matter and are created as intermediate products during methane production, wherein they are immediately converted to methane in the case of an undisrupted methanogenesis. Their enrichment in the fermentation fluid therefore is indicative of a disruption in the decomposition chain (Ross & Ellis 1992). The proof of volatile organic acids is performed via GC; the utilisation of both ion chromatography (IC) and high-pressure liquid chromatography (HPLC) is possible.

Processing of sample

The sample is centrifuged in 50 mL centrifuge tubes for 20 min at 5.300 rpm and 20 °C (device: Avanti 30 centrifuge, Beckman company). The supernatant is first strained through a sieve (mesh width: 0.75 mm) and then filtered with the help of a pressure filtration unit (device: SM 16 249, Sartorius company), in order to free the solution from disruptive fibres and proteins. The filtration unit is equipped with a screening plate, perforated sheet metal, and a nylon membrane filter (pore size: 0.45 µm, diameter: 47 mm, Whatman company or Pall) that is held by a silicone sealing ring. After closing the unit, a pressure of 5 bar is applied and a container is placed below the unit to catch the filtrate. Once the filtration of 7–8 mL of centrifuge supernatant has been completed, approx. 5 mL of the clear filtrate is located in the receiving container. This filtrate is diluted with bi-distilled water in accordance with the expected/assumed acid concentrations and analysed by means of HPLC and/or IC.

Alternative

In order to avoid problems due to contamination of the chromatographic column, the so-called Carrez clarification of the samples can be performed. For this, 1 mL of the centrifugate is mixed with 200 μL of Carrez solution I (15 g potassium hexacyanoferrate $\text{K}_4(\text{Fe}(\text{CN})_6) \times 3 \text{H}_2\text{O}$ in 100 mL distilled water) and intensely shaken (Vortex). After two to five minutes, 200 μL of Carrez solution II, consisting of 23 g zinc chloride in 100 mL distilled water (tip: the velocity of dissolution is improved in a water bath at 70 °C) is added and once again the mixture is intensely shaken. The mixture is subsequently centrifuged for 10 minutes at $10,000 \times g$. The centrifugate is then filtered through a 0.2 μm filter and diluted accordingly prior to the analysis.

A zinc sulphate solution may also be used as the Carrez solution II. This active substance is, however, less active than zinc chloride so that more solution is required for the clarification.

Process of the Analysis

Ion chromatography with suppressed conductivity detection

The IC system DX600 of the Dionex company consists of the quaternary gradient pump GP 50 2, the eluent generator EG 40, the auto sampler AS 50 (for 1.5 mL vials), the conductivity detector CD 25a (with auto-regenerating suppressor) and the analytical separation column IonPac® AS 11 HC (with guard column AG 11 HC, both 4 mm diameter). Chromeleon 6.5 is used as software.

The recommendations of the Dionex company regarding the separation and detection of oxocarboxylic acids (and select anions) can be adopted as operating parameters of the system (c.f. Tab. 4.2-1). A sample chromatogram is depicted in Fig. 4.2-1.

Table 4.2-1: Separation parameters in ion chromatography

Column	IonPac® AS 11-HC	
Flow rate	1.5 mL min ⁻¹	
Temperature	30 °C	
Injection volume	10 μL	
Eluent	NaOH	
	0–8 min: 8–28 min: 28–38 min: 38–39 min: 39–40 min:	Isocratic 1 mM Linear to 30 mM Linear to 60 mM Isocratic 60 mM Linear to 1 mM

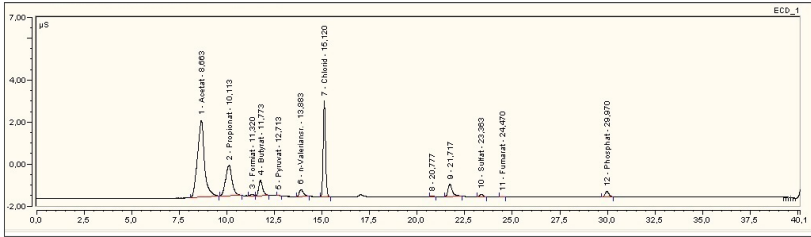

Figure 4.2-1: Sample chromatogram for the determination of the volatile organic acids with the help of an IC (Source: TU Berlin)

High Precision liquid chromatography (HPLC)

The Shimadzu HPLC system consists of the degasser DGU14A, the pump LC10AT, the auto injector SIL10A, the oven CTO10AC and the detector RID10A; the controlling of the individual components is carried out via communications module CBM10A. The column VA 300/7.8 Nucleogel Ion 300 OA (Macherey-Nagel company, dimensions: 4 × 250 mm; guard column: REF 719537) is heated in the oven to 70 °C. The mobile solvent 0.01 N H₂SO₄ moves the injected sample (10 µL) at a rate of 400 µL min⁻¹ through the system and the detection is performed through a measurement of the refractive index (device: RID10A, Shimadzu company). The CLASS-LC10 is being utilised as software.

Solutions of the corresponding salts with concentrations of 28.5–285 mg L⁻¹ are utilised as external standards. The separation of acids is performed under the conditions presented in Tab. 4.2-2. A sample chromatogram is depicted in Fig. 4.2-3.

Table 4.2-2: Separation parameters in high-pressure liquid chromatography (HPLC)

Column	VA 300/7.8 Nucleogel Ion 300 OA
Flow rate	400 µL min ⁻¹
Injection volume	10 µL
Eluent	0.01 N H ₂ SO ₄ (isocratic)

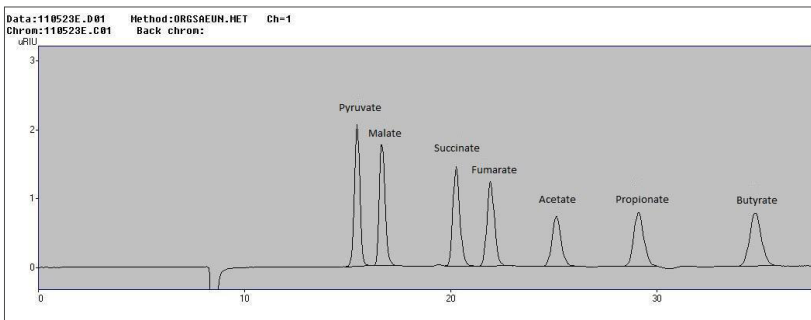

Figure 4.2-2: Sample chromatogram for the determination of the volatile organic acids with the help of an HPLC (Source: UFZ)

4.3 Determination of aldehydes, alcohols, ketones, volatile fatty acids

Erich Kielhorn, Peter Neubauer, Stefan Junne, TU Berlin

Status	The methodology presented describes the processing and GC analysis of biogas samples.
Area of application of the method	Liquid samples without solids, i.e. typically the centrifugate or filtrate of the samples are utilised, since with this method the extra-cellular metabolites, meaning those dissolved in the liquid, are determined.
Advantage	Metabolite concentrations can be detected starting at approximately 1 mg L^{-1} . The labour input for the preparation and analysis is comparatively low. At the same time, the preparation of the sample ensures a degree of purity that reduces column performance loss. A major advantage is the high sensitivity and separation efficiency of the method so that even very small amounts of metabolites can be quantified reproducibly.
Need for research	Detection limits were not investigated so far for all metabolites relevant in anaerobic digestion.

Sample preparation

In order to obtain water-free samples for the GC-MS analysis, the metabolites are extracted from the biogas liquid with chloroform and are derivatised with methyl chloroformate (MCF) prior to transfer into the solvent phase. For better separation of the phases, methanol and a sodium hydrogen carbonate solution (NaHCO_3) are added. As internal standard, 1-propanol can be utilised.

Samples are first centrifuged for 10 min at 4°C and $9,500 \times g$. $200 \mu\text{L}$ supernatant are transferred into an Eppendorf centrifuge tube and mixed with $10 \mu\text{L}$ of 1-propanol solution diluted with distilled water (1:50) as internal standard. Then, $167 \mu\text{L}$ methanol and $34 \mu\text{L}$ pyridine are added. The derivatisation is started by adding $20 \mu\text{L}$ MCF. The mixture is strongly mixed for 30 s (Vortex mixer). Thereafter, another $20 \mu\text{L}$ MCF are added and once again mixed for 30 s.

Now, $400 \mu\text{L}$ chloroform are added in order to extract the metabolites and their derivatives from the reagent mixture. The emulsion is mixed for 10 s. For better phase separation, $400 \mu\text{L}$ 50 mM NaHCO_3 solution are added, followed by 10 s of mixing. The resulting chloroform phase (bottom phase) is carefully transferred with a pasteur pipette into a micro centrifuge tube (1.5 mL). With a molecular sieve bead that is placed in the tube, any residues of water are removed. After a 1 min waiting period, the sample is transferred into GC bottles. Until the measurement, the samples are stored at -20°C .

Materials and devices

For the sample preparation

- 1-propanol $\geq 99.7\%$ (Sigma-Aldrich) #279544
- methanol $\geq 99.9\%$ (Carl Roth) #AE01.1
- pyridine $\geq 99\%$ (Sigma-Aldrich) #CP07.1
- methyl chloroformate (MCF, Aldrich) #M35304
- sodium (Sigma-Aldrich) #528730
- sodium hydrogen carbonate $\geq 99.5\%$ (NaHCO_3 , Carl Roth) #6885.1
- molecular sieve 5 Å (Carl Roth) #8475.1
- GC glass vials 1.5 mL (Fisher) #1072-8684
- micro-inserts 50 μL for 1.5 mL glass vials (Fisher), #1024-4612
- springs for micro-inserts (Fisher) #320 55 76
- 8 mm silicone-coated rubber septums (Fisher) #3146116
- screw tops for glass vials (Carl Roth) #161.1
- pasteur pipettes (Carl Roth) #4518

For the analysis

GC/MS system (Agilent Technologies, Waldbronn, Germany [c.f. Fig. 4.3-1]), consisting of:

- gas chromatograph GC 7890A
- mass spectrometer MSD 5975G

Analytical separation column: FactorFour VF-624ms (Agilent Technologies, Waldbronn) #CP9104

- coating: 6% cyanopropyl/phenyl, 94% dimethylpolysiloxane
- length: 30 m, ID: 0.32 mm
- film: 1.8 μm ,
- temperature limits: $-40\text{ }^\circ\text{C}$ – $300\text{ }^\circ\text{C}$



Figure 4.3-1: GC/MS system (Agilent Technologies, Waldbronn, Germany)

Carrier gas: helium

Execution method

The temperature of the injection chamber is $150\text{ }^\circ\text{C}$; that of the detection chamber is $280\text{ }^\circ\text{C}$. At the start of the analysis, the column has a temperature of $40\text{ }^\circ\text{C}$. Once the sample has been injected, the temperature is increased by $4\text{ }^\circ\text{C min}^{-1}$, up to $150\text{ }^\circ\text{C}$, and maintained for 15 min. Subsequently, an increase in $5\text{ }^\circ\text{C min}^{-1}$ steps is performed, up to the final temperature of $180\text{ }^\circ\text{C}$. Said temperature is maintained for an additional 5 min. $1\text{ }\mu\text{L}$ sample is injected with a 1:20 split (final sample volume $0.05\text{ }\mu\text{L}$).

Analysis of the results

The identification of the substances is performed with the help of a substance database (e.g. the "NIST library"); the quantification is performed with the help of a previously prepared calibration line. The amount of substances can be determined via the peak areas of the chromatogram obtained (c.f. Fig. 4.3-2).

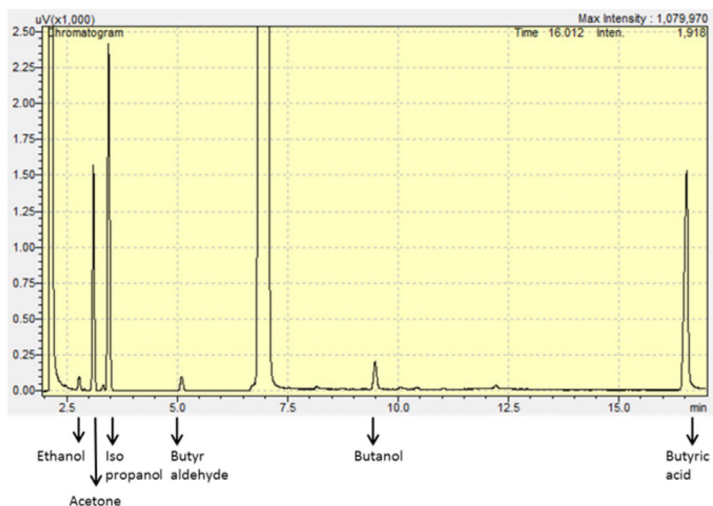

Figure 4.3-2: Sample chromatogram, analysis of aldehydes, alcohols, ketones, and volatile fatty acids

4.4 Examination of samples of solids (substrates) and digestates with HPLC for aliphatic and aromatic acids, alcohols and aldehydes

Martin Apelt, DBFZ

With the help of the method described here, it is possible to test a wide range of analytes in a single sample, which are listed in Tab. 4.4-1:

Table 4.4-1: List of components

Aliphatic acids	Aromatic acids	Alcohols	Aldehydes
Lactic acid Acetic acid Propionic acid Isobutyric acid Butanoic acid Isovaleric acid Valerianic acid	Phenyl acetic acid Benzoic acid	Ethanol 1-propanol 1,2-propanediol	Furfural 5-(hydroxymethyl)furfural (5-HMF)

Status:	This is a not yet validated in-house method of the DBFZ.
Associated standards	(HECHT 2010); HPLC Application ID No.: SI-01153 Agilent; (VDLUGA 1988)
Area of application of the method	Since no interference of the multitude of matrixes has an impact on the analysis results, a wide range of the most diverse matrixes can be tested. At the DBFZ, the determination of the aforementioned components is carried out as in-process control of different fermentation procedures in the area of biogas research and in order to monitor biogas plants already in operation. Furthermore, the testing of the most diverse substrates, that are utilised in the fermentation process, is possible.
Substrates/materials	Testing of digestates from the area of biogas research. Different samples of solids (substrates) that are used in the individual processes.
Limitations of the method	The limitations of the method are imposed by the different calibration ranges (c.f. Tab. 4.4-2). Due to the large calibrating/measurement range, it is possible to analyse virtually all samples without dilution. Since the measurement method – except for phenyl acetic acid and benzoic acid – is not linear over the whole calibration range, two calibration functions are prepared for all other analytes that overlap in their concentration ranges. This way, an exact determination is achieved for the aforementioned calibration range.

Limitations of the method	For the determination of phenyl acetic acid, an additional analysis by means of headspace GC is required, since phenyl acetic acid co-eluates together with the hexanoic acid. If the concentration of hexanoic acid at the headspace GC is below the limit of detection (LOD) of HPLC, the corresponding peak can be quantified as phenyl acetic acid. If, however, in the determination at the headspace GC a concentration of hexanoic acid above the LOD of HPLC is determined, this requires a dilution of the sample. For this, the dilution must be selected such that the concentration of hexanoic acid then achieved will be below the LOD of HPLC.
Advantages	The method is characterised by easy preparation of samples and analytical measurement, which can be applied well for in-process controls with a high throughput of samples. The particular advantage of this method is the determination of lactic acid, aromatic acids, lower alcohols and aldehydes. A low use of additional chemicals for the preparation of samples has a positive effect on the cost effectiveness of this method.
Need for research	To identify process disruptions in biogas plants and fermentation tests more quickly, it will be necessary in the future to identify and quantify additional analytes in the digestates. While important indicators for the progress of a fermentation are determined through the determination of the analytes described, an expansion of the spectrum of analytes would be helpful in order to increase the biogas yield and to identify problems early on. A further optimisation of the method should make it possible to test various saccharides and their decomposition products, and to separate hexanoic acid and phenyl acetic acid.

Reagents

- 5 mM sulphuric acid
- distilled water

Devices and aids

- 1.5 mL HPLC vial with screw cap and 0.5 mL microlitre insert
- 1.5 mL plastic centrifuge tubes
- 1.5 mL plastic centrifuge tubes with 0.2 µm filter insert
- HPLC with refractive index detector (RID) and diode array detector (DAD)
- shaker
- ultrasonic bath

Sample preparation

At a minimum, a double determination is carried out for all samples. In the case of substrates, a minimum of two complete eluates must be prepared for this.

- a) For solid samples (substrates):
Weigh-in 5 g of substrate and eluate with 50 mL distilled water for 24 h on a shaker. Fill eluate through a sieve into a small plastic tube with screw cap.
- b) For digestate samples (e.g. reactor samples):
Prior to the determination, it may be necessary to centrifuge the sample for 10 min at 10 °C and 10,000 rpm. If necessary, subsequent to centrifuging, the sample is strained through a sieve (mesh width approx. 1 mm) in order to remove coarse matrix components.

500 µL of the supernatant or of the filtrate from a) or b) are pipetted as double determination into one Eppendorf tube each with a 0.20 µm filter attachment and centrifuged for 10 min at 10 °C and 15,000 rpm. The filtrate from the Eppendorf tube with filter attachment is pipetted into a 1.5 mL HPLC vial and sealed. If this is not possible, corresponding microlitre inserts for HPLC vials must be used.

Calibration

A separate calibration solution must be prepared for each group of substances. This way, it is possible, in the case of the aliphatic acids, to include hexanoic acid for the determination of phenyl acetic acid. For the calibration of lactic acid, sodium lactate is weighed in and a conversion calculation to lactic acid is performed accordingly. Below, please find the calibration ranges of the individual analytes:

Analysis

A quantitative analysis of the individual analytes is carried out via external standard calibration. For all acids and alcohols, the analysis is performed based on chromatograms from the RID.

Depending on concentration, the aldehyde must be analysed with the RID or DAD at 280 nm. With the RID, very high concentrations of aldehydes can be measured, but the detector features a bad detection sensitivity. Therefore, the analysis in the lower concentration range should be performed with the DAD. In the case of the DAD, please bear in mind that it, in turn, evidences an overload in the case of high concentrations. The respective limits can be found in Tab. 4.4-2.

Table 4.4-2: The calibration utilised

Labelling (Fig. 4.4-1)	Analyte	Detector	Calibration range [mg L ⁻¹]	Retention time [min]	LOD ¹ [mg mL ⁻¹]	LOQ ² [mg mL ⁻¹]
1	Lactic acid	RID	2.35–7064.44	15.9	0.47	1.55
2	Acetic acid	RID	5.22–15669.00	18.4	1.46	4.72
3	1,2- propanediol	RID	5.18–1554.00	20.7	1.80	6.19
4	Propionic acid	RID	1.98–5940.00	21.8	0.64	2.04
5	Isobutyric acid	RID	0.95–2844.00	25.1	0.41	1.28
6	Ethanol	RID	1.97–5920.50	25.9	1.11	3.37
7	Butanoic acid	RID	1.92–5760.00	26.9	0.39	1.28
8	Isovaleric acid	RID	1.86–2790.00	31.6	1.12	2.84
9	1- propanol	RID	4.02–1205.25	32.7	2.65	9.15
	5-HMF	DAD 280nm	2.20–220.00	35.7	1.48	5.19
10	5-HMF	RID	11.00–2200.00	36.0	9.76	34.41
11	Valerianic acid	RID	1.88–2820.00	37.5	0.73	2.02
	Furfural	DAD 280 nm	2.75–275.00	52.0	2.71	10.90
12	Furfural	RID	13.75–2750.00	52.2	10.81	37.72
13	Phenyl acetic acid	RID	14.24–1424.00	55.8	0.11	0.36
14	Hexanoic acid	RID	only for identification	56.3	2.78	9.65
15	Benzoic acid	RID	25.04–2504.00	89.9	4.08	14.24

¹ Limit of detection² Limit of quantification

Device parameters

Table 4.4-3: HPLC settings (Shimadzu)

Eluent	Isocratic with 5 mM sulphuric acid	Column designation	Hiplex H
Detector	RID DAD (for 5-HMF and furfural at 280 nm)	Column dimension	300 × 7.7 mm 8 μm
Flow	0.6 mL min ⁻¹	Guard column	50 × 7.7 mm
Oven temperature	60 °C	Measuring time	95 min
Auto sampler	4 °C	Injection volume	20 μL

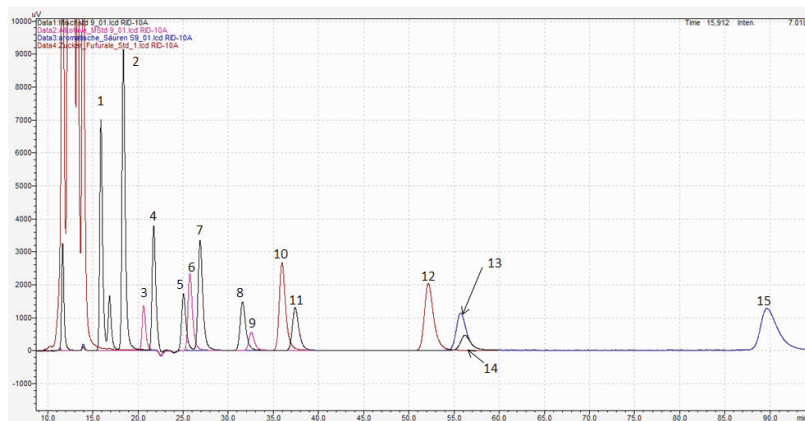

1. Lactic acid	4. Propionic acid	7. Butanoic acid	10. 5-HMF	13. Phenyl acetic acid
2. Acetic acid	5. Isobutyric acid	8. Iso-Valerianic acid	11. Valerianic acid	14. Hexanoic acid
3. 1,2-propanediol	6. Ethanol	9. 1-propanol	12. Furfural	15. Benzoic acid

Figure 4.4-1: Sample chromatogram of all standard mix solutions used on the RID

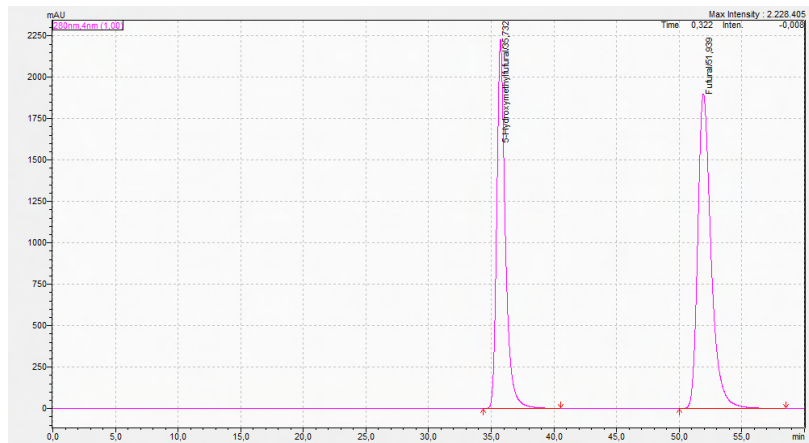

Figure 4.4-2: Sample chromatogram of 5-HMF and furfural at 280 nm

4.5 Determination of sugars and glucose degradation products

Jana Mühlenberg, DBFZ

One parameter that, in addition to others, is characteristic of the fermentability of substrates, is the sugar content. The method frequently used for the determination of reducing sugars with dinitrosalicylic acid (DNA) in some samples produces significantly higher total sugar values than the sum of all the individual sugars that were determined by means of high-pressure liquid chromatography (HPLC). This is caused by the unspecific reaction of DNA with all molecules that feature reducing functional groups (e.g. various aldehydes). The method described here allows the determination of monosaccharides (D-(+)-glucose, D-(+)-xylose, L(-)-galactose, L(+)-arabinose, mannose, D(-)-fructose), a disaccharide (sucrose), sugar alcohols (glycerol, xylitol, D(-)-sorbitol) and that of potential decomposition products which provide for positive results in the DNA test even though they are no sugars.

Status	The method has not yet passed final validation and is still being adjusted with respect to influences by changing matrixes.
Associated standards	Sample preparation from VDLUFA Book of Methods, Volume III; HPLC application of Agilent; addition literature regarding HPLC parameters: (JOURDIER et al. 2012; KORAKLI et al. 2000)
Area of application of the method	The method is suitable for the determination of monosaccharides, disaccharides and sugar alcohols in various substrates. Similarly, biogas reactor contents can be inspected for decomposition products.
Substrates/ materials	Testing of substrates from the area of biogas research, but also of samples from other biomass utilisation processes (e.g. hydrothermal liquefaction of biomasses)
Limitations of the method	Depending on the matrix of the sample, overlaps with other substances may occur. The method is not very flexible since the HPLC column used can only be operated with water as eluent and since the column temperature is limited to 80 °C. Mannose and Fructose are not baseline-separated, but can be analysed.
Advantages	Sugars and decomposition products can be determined in a single analysis. Sample preparation is limited to dilution and filtration and is therefore quick and easy. Water as eluent is not only environmentally friendly but also inexpensive in comparison to other eluents.

Need for research

It may be possible to integrate other decomposition products relevant to the biogas process into the method in order to receive more information from a single analysis. With 90 min, the duration of the analysis is relatively long. New development in column materials in chromatography may, in the future, allow for a shortening of the analysis period. A sample preparation that is geared towards the reduction of matrix effects may also contribute to an improvement of the method. Furthermore, the establishing of an internal standard should be strived for.

Reagents

Millipore water

Devices and aids

- 1.5 mL HPLC vial with screw cap and 0.5 mL microlitre insert
- 1.5 mL plastic centrifuge tubes with 0.2 µm filter insert
- 1.5 mL plastic centrifuge tubes

Device parameters

An HPLC of the Agilent company was used for the analyses. The 1200 series is equipped with a degasser (G1379B), a binary pump (G1312A), an autosampler (G1329A), an autosampler thermostats (G1330B), a column oven (G1316A), a diode array detector (DAD) (G1315D) and a refractive index detector (RID) (G1362A). The individual parameters are compiled in Tab. 4.5-1.

Table 4.5-1: Overview of the parameters for HPLC

Eluent	Ultrapure water, isocratic	Measuring time	90 min
Detector	RID DAD (for 5-HMF and furfural at 280 nm)	Auto sampler	80 °C
Flow	0.35 mL min ⁻¹	Auto sampler	15 °C
Columns	MetaCarb 87P 300 x 7,8 mm MetaCarb 87P (pre-column) 50 x 4,6 mm	Injection volume	10 µL

Sample preparation

At a minimum, a double determination is carried out for all samples. In the case of substrates, a minimum of two complete eluates must be prepared for this.

a) For solid samples (substrates):

Weigh-in 5 g of substrate and elute with 50 mL distilled water for 24 h on a shaker. Fill eluate through a sieve into a small plastic tube with screw cap.

b) For digestate samples (e.g. reactor samples):

Prior to the determination, the sample is centrifuged for 10 min at 10 °C and 10,000 rpm. If necessary, subsequent to centrifugation, the sample is strained through a sieve (mesh width approx. 1 mm) in order to remove coarse matrix components. 500 µL of the supernatant and/or the filtrate from a) or b) are pipetted as double determination into an Eppendorf tube with 0.20 µm filter insert and centrifuged for 10 min at 10 °C and 15,000 rpm. The filtrate from the Eppendorf tube with filter insert is pipetted into a 1.5 mL HPLC vial and sealed. If only little filtrate is present, corresponding microlitre inserts for HPLC vials must be used.

Calibration

A combined calibration solution is prepared for the monosaccharides (except for mannose). Mannose was calibrated separate due to the overlap with fructose. Similarly, separate standards were manufactured for the decomposition products acetaldehyde and hydroxyacetone as well as 5-(hydroxymethyl)furfural (5-HMF) and furfural. The retention times, calibration ranges, detectors used, as well as limits of detection and quantification (LOD and LOQ) are compiled in Tab. 4.5-2.

Analysis

For the quantitative analysis, the external calibration is used. In this, sugar and sugar alcohols are analysed via the refractive index detector (RID). The determination of furfural and 5-HMF is carried out in the lower calibration range via the diode array detector (DAD) at 280 nm. From this, the limits of detection and quantification for furfural and 5-HMF were determined, too. Values above 100 mg L⁻¹ have to be analysed by the RID. If both D-(-)-sorbitol and furfural are present in the sample, there is a slight overlap of the signals in the RID, starting at an amount of approx. 60 mg L⁻¹ furfural. Via a back calculation it is then possible, after analysis of the furfural, to deduct this area share and calculate the amount of D-(-)-sorbitol. If the share of D-(-)-sorbitol is significantly higher than that of furfural, it is also possible to dilute the sample in order to obtain a "furfural-free" RID signal for D-(-)-sorbitol.

Table 4.5-2: Overview of substances with retention time, calibration range, LOD, LOQ, and detector

Analyte	Detector ^{a)}	Calibration range [mg L ⁻¹]	Retention time [min]	LOD [mg L ⁻¹]	LOQ [mg L ⁻¹]
Sucrose	RID	2.48–990.00	19.38	3.77	13.32
D-(+)-Glucose	RID	1.00–1000.00	23.27	6.47	12.58
D-(+)-Xylose	RID	5.04–1008.00	25.13	12.25	42.93
L(-)-Galactose	RID	4.03–806.00	27.74	8.53	30.94
L-(+)-Arabinose	RID	2.45–980.00	30.42	15.32	53.25
L(-)-Mannose	RID	1.10–1096.50	32.22	4.00	15.55
D(-)-Fructose	RID	2.57–1336.00	33.83	6.04	21.30
Glycerol	RID	2.59–1035.00	36.29	6.51	22.94
Xylitol	RID	4.97–993.00	70.11	9.15	32.14
D(-)-sorbitol	RID	2.45–978.00	79.54	6.39	22.89
Acetaldehyde	RID	1.85–370.00	29.20	3.20	12.66
Hydroxyacetone	RID	2.30–460.00	45.04	4.98	21.95
5-HMF	DAD 280 nm	3.50–87.50	62.65	6.15	22.12
	RID	87.50–1750.00	63.04		
Furfural	DAD 280 nm	4.16–104.05	81.75	8.52	30.49
	RID	104.05–2081.00	82.23		

^{a)} RID – refractive index detector; DAD – diode array detector

Sample chromatogram

Using the aforementioned parameters, chromatograms as depicted in Fig. 4.5-1 result.

a)

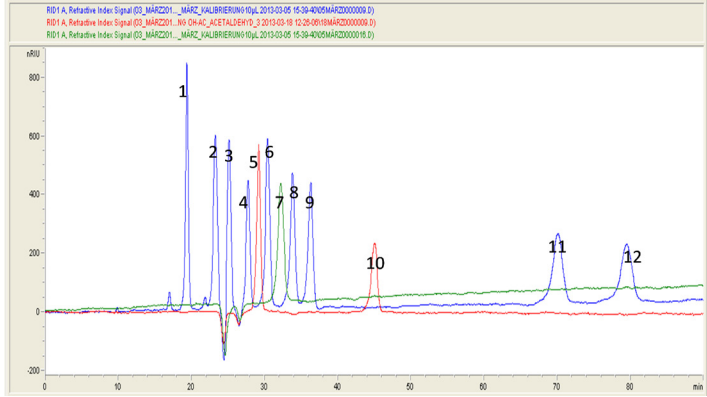

b)

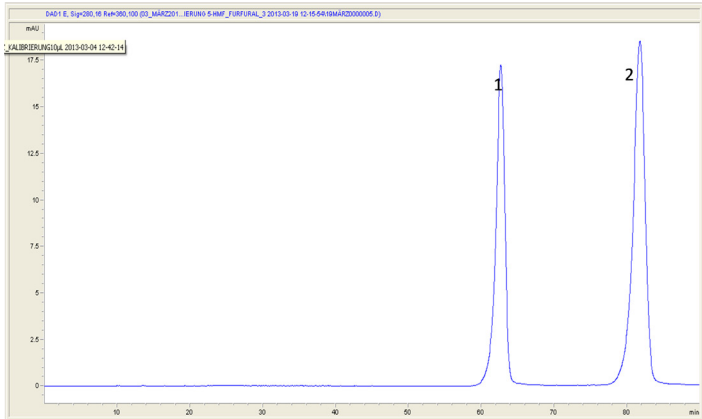

Figure 4.5-1: Affiliation of the substances; (a) RID: 1) sucrose; 2) D-(+)-glucose; 3) D-(+)-xylose; 4) L-(-)-galactose; 5) acetaldehyde; 6) arabinose; 7) mannose; 8) D-(+)-fructose; 9) glycerol; 10) hydroxyacetone; 11) xylitol; 12) D-(-)-sorbitol; (b) DAD (280 nm): 1) 5-(hydroxymethyl)furfural (5-HMF); 2) furfural

4.6 Determination of carbohydrates based on GC-MS analytics

Erich Kielhorn, Peter Neubauer, Stefan Junne; TU Berlin

Status	The method presented is based on a 1986 publication regarding sugar analysis. In this publication, mixtures of pure monosaccharide standards were analysed. In late 2011, the method was adjusted for the analysis of carbohydrates in liquid samples from biogas plants. The main principles of the analysis is published (Li & ANDREWS 1986).
Associated standards	Nitrogen determination according to Kjeldahl
Substrates	Utilised as substrate are liquid samples without solids, i.e. typically the centrifugate or filtrate of the samples. Extracellular carbohydrates, meaning those dissolved in the liquid, are determined with this method.
Limitations of the method	Carbohydrate concentrations can be detected starting at approx. 1 mg L^{-1} . One disadvantage is that the samples must be inactivated directly on-site in order to suppress any further metabolic activity. This is presently done by adding KOH (addition of 2 vol.-% of a 30 % KOH solution). Furthermore, an immediate cooling of the samples is desirable, which can be performed on-site with little effort. The drying of the samples takes several hours so that the analysis of the sample(s) typically takes two days.
Advantages	Other than that, the input of labour for the preparation and analysis is comparatively low. A major advantage is the high sensitivity and separation efficiency of the method so that even small amounts of sugars can be detected and quantified reproducibly.
Need for research	Even though the centrifugate is being analysed, after drying the samples residues remain that cannot be dissolved with the solvent. To that extent, it remains to be determined whether or not the sugars contained are transferred into the solvent completely or only in part.

Sample/data preparation

Since carbohydrates are low-volatility compounds, a two-stage derivatisation of the carbohydrates is performed. In the first step, the aldehyde groups of the carbohydrates are converted into oximes by hydroxylamine. In the second step, the silylation with hexamethyldisilazane is carried out. As internal standard, phenyl- β -D-glucopyranoside is utilised.

The samples are first centrifuged for 10 min at 4 °C and $9,500 \times g$. 1 mL of the supernatant is placed in a GC glass vial and dried for ≥ 8 h in the rotary evaporator under vacuum and at room temperature. The gentle evaporation of the sample serves for removing the water that would interfere with the analysis. Subsequent to the complete evaporation of the water, the remaining total solids are resuspended in 0.5 mL pyridine solution (prepared earlier: 25 mg mL^{-1} hydroxylamine hydrochloride for oxime formation and 1 mg mL^{-1} phenyl- β -D-glucopyranoside as internal standard dissolved in pyridine) and sealed and incubated in the water bath at 75 °C for 30 min. After cooling down, 0.5 mL hexamethyldisilazane and 15 μL trifluoroacetic acid are added. The precipitate that forms is separated by centrifugation at $9,500 \times g$ (room temperature) for 10 min. The supernatant is transferred into GC vials. The samples are stored at -20 °C prior to analysis.

Materials and devices

For the sample preparation:

- pyridine stock solution, consisting of:
pyridine ≥ 99 % (Carl Roth) #CP07.1
hydroxylamine hydrochloride ≥ 98 % (Sigma-Aldrich) #255580
phenyl- β -D-glucopyranoside (Sigma-Aldrich) #78554
- hexamethyldisilazane ≥ 98 % (Carl Roth) #3840.1
- trifluoroacetic acid ≥ 99 % (Carl Roth) #PO88.1
- micro centrifuge tubes 2 mL (Carl Roth) #CK06.1
- transparent GC sample glass vials 2 mL (Carl Roth) #159.1
- glass inserts 100 μL for 2 mL glass vials (Carl Roth), #C516.1
- 8 mm silicone-coated rubber septums (Carl Roth) #164.1
- screw caps for glass vials, (Carl Roth) #161.1
- centrifuge CT15RE® (himac laboratory centrifuge)
- vacuum centrifuge/"Speedvac" (Bachofer)
- vortex mixer (neolab®) and Water bath (GFL)

For the analysis

- GC/MS system (Agilent Technologies, Waldbronn, Germany), consisting of: autosampler AS G26 14A | injector 76 83B | gas chromatograph GC 7890A | mass spectrometer detector MSD 5975G | software G 1701 EA
- analytical separation column: Agilent J&W DB-5MS (Agilent Technologies, Waldbronn, Germany) #122-5523
coating: phenyl-arylene polymer, comparable to (5%-phenyl) methyl polysiloxane
length: 30 m, ID: 0.25 mm, film: 0.25 μm , temperature limits: -60 to 325/350 °C
- carrier gas: helium
- isopropanol

Execution method

For the analysis of the carbohydrates, a gas chromatograph GC 7890A (Agilent) with a mass spectrometer is utilised. The separation of the carbohydrates is achieved via a quartz glass column (coated with phenyl-arylene polymer, comparable to (5%-phenyl) methyl polysiloxane), through which the carrier gas helium is flowing. The addition of sample corresponds to 0.2 μL . 2 μL sample are injected with a 1:10 split (final sample volume 0.2 μL). The temperature of the injection chamber is 155 °C; that of the detection chamber is 300 °C. At the start of the analysis, the column has a temperature of 155 °C. Once the sample has been injected, the temperature is increased by 4.5 °C per minute, up to a final temperature of 280 °C, and maintained constantly for another 10 min.

Analysis

The analysis is performed with the "GCMSD Data Analysis" software programme from Agilent. Both the identification of an unknown substance as well as its quantification are possible. Based on the mass fraction of a substance determined by the mass spectrometer, the unknown molecule can be identified via a pre-installed substance library ("NIST"). Subsequent to the identification, the quantification is performed by first analysing a standard with a defined concentration and then creating a calibration line. Via the peak areas of the chromatogram obtained, the amount of the substances contained can be determined.

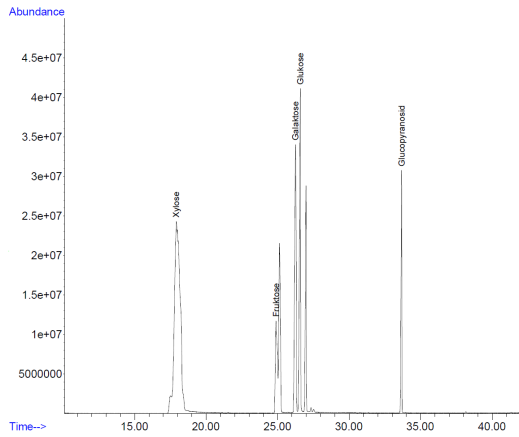

Figure 4.6-1: Sample chromatogram, analysis of carbohydrate standards

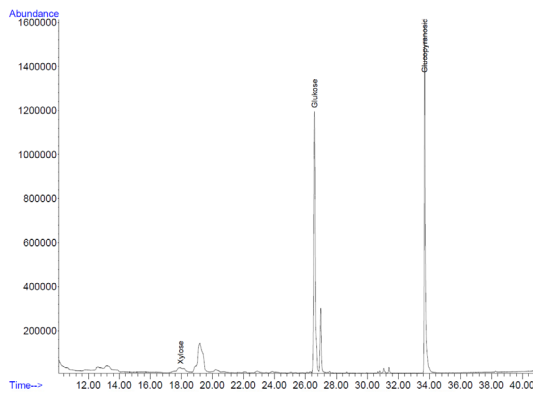

Figure 4.6-2: Sample diagram, liquid sample from the hydrolysis tank of a biogas plant

4.7 Determination of total Kjeldahl nitrogen and crude protein

Michael Dittrich-Zechendorf, DBFZ

Status	The method is an in-house method that is carried out by modeling it after the prescribed method of VDLUFA, Book of Methods III, Testing of Feedstuffs, Determination of Crude Protein, Official Method, Hamburg 1988 (VDLUFA 1988).
Associated standards	Nitrogen determination according to Kjeldahl
Area of application of the method	Determination of the crude protein content of feedstuffs based on determined nitrogen contents (according to Kjeldahl)
Disadvantages	Lengthy. May be potentially falsified due to, for example, melamine (or other nitrogen sources) (non-specific method) The fixed factor must be adjusted, depending on the sample, where applicable.
Advantages	Nitro, nitroso and azo compounds are not being detected.
Need for research	For this method, there is no need for research.

Through an acidic thermal decomposition under catalyst involvement, protein(s) and other compounds containing nitrogen are split into ammonia. Ammonia is released by means of alkaline water vapour distillation and captured in boric acid. Subsequently, a quantitative determination of the ammonia takes place by means of sulphuric acid titration. The share of ammonia determined allows for conclusions regarding the nitrogen bound in the protein. For this, the factor 6.25 is used for the conversion of the nitrogen content to the crude protein content. The method is carried out according to the determination according to Kjeldahl.

Devices and chemicals

- devices: Turbosog, Turbotherm, Kjeldatherm, Vapodest 50sc
- decomposition vessels and accessories
- 1.5L beaker
- 250mL wide-neck Erlenmeyer flask
- drying cabinet
- precision scale
- cucible
- desiccator

- boric acid 2%
- sulphuric acid (nitrogen-free) 0.025 mol L⁻¹ (normality: 0.05 mol L⁻¹)
- soda lye (nitrogen-free) 32%
- ammonia sulphate (NH₄)₂SO₄ at least 99,5% (p. a.)
- catalyst tablets (CuSO₄ × 5 H₂O, Na₂SO₄, Se)
- aqua dist.

Preparation of the analysis

The analysis is carried out on sample wet weight (fresh matter). Both liquid and solid samples can be analysed. At a minimum, a double determination is carried out for each sample.

Execution of the analysis

Thermal decomposition

For the analysis, approximately 0.3 g_{TS} (m₁) are weighed-in with an accuracy of 0.1 mg. Distilled water is used as blank reading, and ammonia sulphate [(NH₄)₂SO₄] as standard substance. Two catalyst tablets are placed in each decomposition vessel, covered with 20 mL 98% sulphuric acid, and placed in the glass on a heating block. The suction extraction facility is placed on top of this. The samples are decomposed for 55 min at 230 °C and subsequently for 1:15 h at 390 °C, wherein the solution should have taken on a clear green colouring. Once the decomposition has ended, let it cool down for approx. 20 min. Subsequently, approx. 90 mL boiling water (aqua dist.) are layered underneath, running down the side of the glass.

To prevent the crystallising out of the sulphate, the samples are once again placed on the still warm heating block.

Alkaline water vapour distillation

The decomposition vessels are placed in the distillation device, and subsequent to addition of 66 mL soda lye, distilled for 5 min at 100% steam output. Within the process, the distillate is transferred into 60 mL boric acid. Then the boric acid is titrated with 0.1 N sulphuric acid until pH = 5.

Calculation of the total Kjeldahl nitrogen content

$$\text{TKN} = \frac{(V_1 - V_0) \cdot c \cdot f \cdot 0.014}{m \cdot 100}$$

08

TKN	Total Kjeldahl nitrogen content	% FM
V ₁	Volume of the sulphuric acid consumed when titrating the sample	mL
V ₀	Volume of the sulphuric acid consumed when titrating the blank reading	mL
c	Normality of the acid	mol L ⁻¹
f	Factor of the acid	
m	Mass of the sample	g

Calculation of the protein content

$$CP = TKN - \left(NH_4^+ - N \cdot \left(\frac{100 - TS}{1000} \right) \right) \cdot 6.25$$

09

CP	Protein content	% FM
TKN	Total Kjeldahl nitrogen content	% FM
$NH_4^+ - N$	TAN (total ammonia nitrogen)	$g L^{-1}$
TS	Total solids content of the sample	%

For all samples, the dry matter must be determined in order to be able to put the result in relation to the total solids. In addition, the ammonia nitrogen content (TAN) must be measured in order to calculate the protein content.

4.8 Determination of the protein content

Lucie Moeller, UFZ; Kati Görsch, DBFZ

Status	This method was developed following the method for the determination of the crude protein content according to Dumas.
Associated standards	Determination of crude protein according to Dumas.
Substrates/ materials	This method is suitable for samples with total solids contents of up to approx. 7 %.
Measuring range	0.1–100 mg L ⁻¹ TN (total nitrogen)
Disadvantages	A TOC/TN analyser is necessary in order to determine the nitrogen content.
Advantages	The method is quick and easy to execute.
Need for research	For this method, there is no need for research.

For the description of the properties of the foams generated during biogas production, a protein determination is required. Due to the characteristics of samples originating from biogas plants, the utilisation of spectrophotometric methods for protein determination (e.g. Bradford, Lowry) is difficult and leads to measuring inaccuracies. For this reason, an analysis for the determination of the content of N-protein (DUMAS 1831) was developed.

The total protein content of a sample is calculated based on the following formula:

$$\text{Total protein} = 6.25 \cdot (\{\text{TN}\} - \{\text{NH}_4\text{-N}\} - \{\text{NO}_3\text{-N}\} - \{\text{NO}_2\text{-N}\})$$

10

{TN}	Total nitrogen from the homogenised sample	mg L ⁻¹
{NH ₄ -N}	Total ammonia nitrogen (TAN) from the filtrate	mg L ⁻¹
{NO ₃ -N}	Nitrate nitrogen from the filtrate	mg L ⁻¹
{NO ₂ -N}	Nitrite nitrogen from the filtrate	mg L ⁻¹

For the determination of the total, ammonium, nitrate, and nitrite nitrogen, several sub-steps are required. Nevertheless, in comparison to other sample determination methods for intensely coloured samples (e.g. Kjeldahl), this method is relatively quick to execute. A comparison of the results from this method with those of the conventional, more laborious method according to Kjeldahl (DIN EN 25 663) showed a deviation of 5 %.

Determination of the TN content from the homogenised sample

Processing of sample

The sample is homogenised with the help of a conventional immersion blender. Of this, two times 5 mL are filled in measuring cylinders (in the case of very liquid samples with solids contents of less than 5%, the utilisation of a 5 mL pipette is possible). The homogenic sample is transferred into 50 mL volumetric flasks and filled up with distilled water to the calibration mark. Of these 1:10 dilutions once again two times 5 mL each are filled into volumetric flasks and filled up to 50 mL, so that four samples (each with a 1:100 dilution) can be measured. These dilutions are subsequently filtered through a 250 µm mesh sieve in order to free the solutions of interfering fibres.

The samples are measured for TN by means of a TOC analyser.

Measuring process

For the determination of the TN content, the TOC-V_{CSH/CSN} device with a TN unit (Shimadzu company) was used. The measuring principle of the device is based on a combustion of the sample at 720 °C, wherein the nitrogen present in the sample is converted into nitrogen monoxide which is detected by chemoluminescence. Due to the difficulty of measuring 5 mL homogenised sample, a relative error of ± 15% should be taken into consideration.

Determination of the ammonia nitrogen concentration of the filtrate

Processing of sample

The sample is centrifuged for 20 min at 5,300 rpm and 20 °C in 50 mL centrifuge tubes (device: Avanti 30 centrifuge, Beckman company). The supernatant is strained through a sieve (mesh width: 720 µm) and transferred into a pressure filtration unit (device: SM 16 249, Sartorius company) with nylon membrane filter (pore size: 0.45 µm, Whatman company or Pall). The exact description of the device is provided in Ch. 4.2 "Determination of organic acids". Depending on the anticipated ammonia nitrogen concentration, the filtrate is diluted with distilled water (based on experience, at least 1:1,000).

Measuring process

For the determination of the ammonia nitrogen (TAN) content, a photometric test of the Merck company is utilised (Spectroquant, in accordance with DIN 38406 E5, measuring range: 0.01–3 mg L⁻¹ NH₄-N). The photometric measurement is carried out in a quartz cuvette (10 mm side length) with the Multilab P5 device (WTW company).

Determination of the ammonium and nitrite nitrogen concentrations from the filtrate

For nitrate, the sample is treated in accordance with the provisions of the Spectroquant nitrate test (Merck company, in accordance with DIN 38405 D9, measuring range: 1.0–25.0 mg L⁻¹ NO₃-N). The photometric measurement against a blank is carried out in single-use cuvettes (10 mm side length) with the Cadas 200 device (Dr. Lange company).

The presence of nitrite in the sample can be checked with the help of a test strip (Merckoquant nitrite test, Merck company, measuring range: 0.5–10 mg L⁻¹).

4.9 Determination of crude fat

Michael Dittrich-Zechendorf, DBFZ

Status	The method is an in-house method that is carried out modelled after the prescribed method of VDLUFA, Book of Methods III, Testing of Feedstuffs, Determination of Crude Fat, Ch. 5.1.1, Official Method, Procedure B, Hamburg 1988 (VDLUFA 1988).
Associated standards	Determination of crude fat, official method
Area of application of the method	Determination of crude fat in feedstuffs. Not suitable for oilseeds.

The sample is heated with hydrochloric acid in order to open up (decompose) proteins and release bound lipids. The decomposition solution is filtered and, after drying, the fat remaining in the filter is extracted with hexane. The solvent is distilled off and the dried residue is weighed. The fat content is calculated from the difference between the weighing-in and weighing-out.

Devices and chemicals

- Soxhlet extraction unit Makro and Multistat device
- precision scale
- hydrolysis automaton "Hydrotherm"
- pleated filter with an average pore diameter of approx. 5 µm
- drying cabinet
- desiccator
- weighing paper, fat-free
- crucible
- pH indicator paper
- wadding, chemically pure and degreased
- extraction beaker(s)
- extraction sleeves
- sleeve holder(s)
- compressor at least 4.5 bar
- water supply at least 0.5 bar
- hydrochloric acid 3 mol L⁻¹
- hexane
- aqua dist.
- where applicable, liquid N₂
- where applicable, dry ice

Preparation of the analysis

Prior to the analysis, the fresh samples are ground to ≤ 1 mm; where applicable, they are embrittled for this by means of liquid nitrogen and solid CO_2 (dry ice). A double determination is carried out. The dry matter of the dried sample must be determined in order to be able to put the result in relation to the total solids.

Execution of the analysis

Hydrolysis

Approximately 2.5 g of a fresh sample – accurate to 0.1 mg – are placed on the weighing paper, which is then folded together. The paper, together with the sample, is put into a hydrolysis beaker to prevent baking onto the beaker's bottom while heating it up. Subsequent to the addition of 100 mL 3 mol L^{-1} hydrochloric acid, an automatic heating to boiling temperature takes place and is held for 1 h at mild simmering. It has proven advantageous to continue the simmering process until the complete decomposition of the substrate. Where applicable, rinse the border that occurred into the glass with some HCl and continue the simmering process. Subsequent to the completion of the hydrolysis, the decomposition mixture is drained into the prepared pleated filter and rinsed with hot distilled water. The pleated filters are rinsed 16 times with 40 mL distilled water, each. The filters should be pH-neutral (testing by means of Unitest paper). The filters are then placed on watch glasses and dried over night in the drying cabinet at 50°C . Depending on the number of samples, the extraction beakers are dried with three boiling stones, each, for at least 1 h in the drying cabinet at 105°C , or – preferably – over night at 50°C .

Extraction

Subsequent to the cooling down in the desiccator, the extraction beakers are weighed accurate to 0.1 mg and the mass (a) is recorded. Subsequent to the cooling down in the desiccator, the dried filters are transferred into an extraction sleeve and covered with fat-free wadding. The prepared sleeve is placed in the appropriate holder and [then] placed into an extraction glass. Into this glass hold with round-nose pliers, 140 mL of fresh hexane are added. The glass is immediately placed in the ready-to-operate extraction unit. The extraction takes place according to the programme described in Tab. 4.9-1.

After the completion of the programme, the extraction beaker is removed from the extraction unit and the extraction sleeves with the corresponding holders are removed and disposed of (and/or reused). The extraction beakers are dried in horizontal position for 2 h at 50°C in the drying cabinet. After cooling down to room temperature in the desiccator, a weighing accurate to 0.1 mg is carried out and the mass (b) is recorded. Drying and weighing must take place immediately one after the other.

Table 4.9-1: Programme of the extraction unit

Programme step	Programme parameter(s)	Comment
T category	135 = < 200–300 °C	
Hot plate temperature	150 °C	
Lowering interval	4 min	
Lowering impulse	3 s	
Boiling phase	30 min	
Removal by distillation A	4 intervals	Subsequent to A the solvent level should be at least 10 mm below the sleeve
Extraction time	1 h	
Removal by distillation B	4 intervals	Subsequent to B the solvent level should be at least 10 mm below the sleeve
Removal by distillation C	2 min	

Calculation of the fat content

$$CF = \frac{b - a}{(0.01 \cdot TS_{md} \cdot m) \cdot 100}$$

11

CF	Crude fat content	% _{TS}
a	Mass of the empty extraction vessel	g
b	Mass of the extraction vessel after the extraction	g
TS _{md}	Total solids of the dried and milled sample	%
m	Mass of the dried and milled ample	g

4.10 Determination of crude fibre

Michael Dittrich-Zechendorf, DBFZ

Status	The method is an in-house method that is carried out modelled after the prescribed method of VDLUFA, Book of Methods III, 2nd Supplement, Hamburg 1988 (VDLUFA 1988).
Associated standard	Determination of crude fibre, official method
Area of application of the method	This method determines the acid-insoluble and alkali-insoluble, fat-free, organic share in feedstuffs.
Disadvantages	Non-specific method, no indications regarding the individual fibre fractions.
Need for research	For this method, there is no need for research.

The dried sample is treated by boiling in H_2SO_4 and KOH. The undissolved residue is weighed out after drying and then turned to ash. The difference between the ash content and the undissolved residue is referred to as crude fibre. These skeletal substances essentially include: cellulose, hemicellulose, pentosans, lignin, cutin and pectin.

Devices and chemicals

- fibretherm FT 12 device
- fibrebag & accessories
- drying cabinet
- muffle furnace
- precision scale
- crucible & desiccator
- sulphuric acid 0.13 mol L⁻¹
- potash lye 0.23 mol L⁻¹
- hexane
- aqua dist.
- boiling stones

Preparation of the analysis

The samples must be dried in the drying cabinet at 105 °C for approx. 24 h and subsequently ground to ≤ 1 mm. Furthermore, for each sample a crucible must be calcined empty at 500 °C for 2 h. A double determination is carried out. In addition, corresponding to the number of samples, Fibrebags must be dried in the drying cabinet at 105 °C for 1 h.

Execution of the analysis

Subsequent to the drying, the empty weight of the Fibrebags is determined. Then, approx. 1 g of dried sample must be weighed, accurate to 0.1 mg. A glass spacer is carefully inserted into the Fibrebags and together are placed in the sample carousel. All Fibrebags are thoroughly rinsed with a spray bottle filled with hexane. This way, excess fat is eluted from the samples. The sample carousel should be dried in the drying cabinet (105 °C) for approx. 5 min and be subsequently placed in the boiling container.

Table 4.10-1: Method for the determination of crude fibre

1	Dosage	H ₂ SO ₄	1 L
2	Heating	45 %	0 h 30 min
3	Suctioning off		2 min/30 s
4	Washing cycle 1/2		
5	Washing cycle 2/2		
6	Dosage	KOH	1 L
7	Heating	40 %	0 h 30 min
8	Cooling	91 > 85 °C	
9	Suctioning off		2 min/30 s
10	Washing cycle 1/2		
11	Washing cycle 2/2		
12	Dosage	H ₂ O wash	1 L
13	Heating	50 %	0 h 5 min
14	Cooling	90 > 60 °C	
15	Method completed		

To determine the dried mass of the Fibrebags, first, the empty weight of an empty crucible calcined at 500 °C is determined. After removal of the spacer, the Fibrebag is placed in the crucible rolled up. The crucibles are dried for approx. 24 h at 105 °C, cooled down in the desiccator, and weighed. The ashing of the Fibrebags is carried out at 500 °C for at least 2 h. After cooling down, the samples are weighed. In addition, the dry matter of the analysis sample must be determined in order to be able to put the result in relation to the total solids.

Result calculation

$$\text{CFC} = \frac{(m_4 - m_1) - (m_5 - (m_6 - m_3))}{(m_2 - m_1) \cdot \text{TS}_{\text{md}}} \cdot 100 \cdot 100$$

12

CFC	Crude fibre content	% _{TS}
m ₁	Mass of the empty dried Fibrebag	g
m ₂	Mass of the dried Fibrebag with sample	g
m ₃	Mass of the empty crucible of the blank reading	g
m ₄	Mass of the crucible & Fibrebag & sample after drying	g
m ₅	Mass of the crucible & Fibrebag & sample after calcination	g
m ₆	Mass of the crucible & Fibrebag after calcination of the blank reading	g
TS _{md}	Total solids of the dried and milled sample	%

Table 4.10-2: Method for the determination of ADF

1	Dosage	ADF solution	1.3 L
2	Heating	34 % (device-dependent)	1 h
3	Suctioning off		2 min/30 s
4	Washing cycle 1/2		
5	Washing cycle 2/2		
6	Dosage	H ₂ O wash	1.3 L
7	Heating	50 % (device-dependent)	0 h 5 min
8	Cooling	90 > 60 °C	
9	Suctioning off		2.5 L
10	Dosage	H ₂ O wash	1.3 L
13	Heating	55 % (device-dependent)	0 h 2 min
14	Cooling	90 > 60 °C	
15	Method completed		

4.11 Process specification for the determination of ADF and ADL

Michael Dittrich-Zechendorf, DBFZ

Status	The method is an in-house method that is carried out modelled after the prescribed method of VDLUFA, Book of Methods III, 2nd Supplement, Hamburg 1988 (VDLUFA 1988).
Associated standards	Determination of ADF and ADL, official method
Area of application of the method	This method determines the acid-insoluble components and the crude lignin of a sample.
Need for research	For this method, there is no need for research.

By boiling the dried samples in acidic ADF solution, cellulose, lignin and lignin-*N*-compounds are not eluted from the feedstuff. This undissolved residue is weighed out after drying. The residue remaining in the filter crucible in the determination of the ADF is treated at room temperature for 3 h with 72% sulphuric acid. Subsequently it is rinsed with hot water to the neutral point, dried, and weighed. After ashing the organic substance, the substance is weighed again; the loss on ignition corresponds to the "crude lignin".

Devices and chemicals

- fibretherm FT 12 device, fibrebag (ADF) & accessories
- drying cabinet and Muffle furnace
- precision scale
- 5 L beaker
- crucible & desiccator
- acidic ADF solution
- hexane
- 72% sulphuric acid
- aqua dist.

Preparation of the analysis

The samples must be dried in the drying cabinet at 105 °C for approx. 24 h. Furthermore, for each sample two crucibles must be calcined empty at 500 °C for 2 h. The dried samples are ground with a mill to ≤ 1 mm. A double determination is carried out. The Fibrebags must be dried in the drying cabinet at 105 °C for 1 h.

Manufacturing of detergents for the ADF determination

Devices

- 5 L volumetric flask
- 50 L volumetric bulb pipette
- top unit scale
- glass funnel
- 250 L beaker
- piston pipette
- small weighing bowl(s)

Chemicals

- aqua dist.
- sulphuric acid (H_2SO_4) 98 %
- *N*-cetyl-*N,N,N*-trimethyl ammonium bromide

Manufacturing of the ADF solution

In a 5 L volumetric flask, approx. 2 L distilled water are placed and 136 mL concentrated sulphuric acid are pipetted in. In addition, 100 g *N*-cetyl-*N,N,N*-trimethyl ammonium bromide are transferred into the volumetric flask. Subsequent to intermixture and cooling down, it is filled up with distilled water up to the calibration mark. The solution is stored in the dark at 18–20 °C.

Execution of the ADF analysis

Subsequent to the drying at 105 °C, the empty weight of the Fibrebags is determined and recorded (m_1). Then, approximately 1 g of dried sample must be weighed in accurate to 0.1 mg. The mass of the sample in the Fibrebag must be recorded (m_2). A glass spacer is carefully inserted into the Fibrebags and both are placed in the sample carousel. All Fibrebags are thoroughly rinsed with hexane. This way, excess fat is eluated from the samples. The duration and sequence of the process steps of the Fibretherm FT 12 can be found in Tab. 4.11-1.

After completion of the method, the Fibrebags must be dried in the drying cabinet over night at 105 °C and the mass must be recorded (m_4).

If ADL (crude lignin) is to be determined, the "Execution of ADL analysis" must be carried out thereafter. If lignin does not need to be determined, at this point the ashing in the muffle furnace is carried out at 500 °C for at least 2 h. Subsequent to cooling down of the sample in the desiccator, the sample is weighed and the weight is recorded (m_5). The ash determination obtained here is, for the most part, identical to the ash determination from the TS/VS determination (Ch. 3.1).

Execution of the ADL analysis

In preparation, dry crucibles and Fibrebags at 105 °C for 24 h. For the ADL determination, additionally the Fibrebags weighed for the determination of the ADF (prior to the ashing!) are hung in a sample carousel and secured. Subsequently, the sample carousel with the Fibrebags is placed in a 5 L beaker and covered at room temperature with 72 % sulphuric acid. The sulphuric acid is stirred every hour and during this period is kept for 3 h at a temperature of 20–23 °C. Subsequently, it is rinsed with hot water to the neutral point and dried for 24 h at 105 °C (m_7).

Table 4.11-1: Method for the determination of ADF

1	Dosage	ADF solution	1.3 L
2	Heating	34 % (device-dependent)	1 h
3	Suctioning off		2 min/30 s
4	Washing cycle 1/2		
5	Washing cycle 2/2		
6	Dosage	H ₂ O wash	1.3L
7	Heating	50 % (device-dependent)	0 h 5 min
8	Cooling	90 > 60 °C	
9	Suctioning off		2.5L
10	Dosage	H ₂ O wash	1.3L
13	Heating	55 % (device-dependent)	0 h 2 min
14	Cooling	90 > 60 °C	
15	Method completed		

The ashing of the Fibrebags is carried out at 500 °C for at least 2 h in the muffle furnace. Subsequent to cooling down in the desiccator, the samples are weighed out and the mass is recorded (m_3). In addition, the dry matter of the analysis sample must be determined in order to be able to put the result in relation to the total solids.

Result calculation

$$\text{ADF} = \frac{(m_4 - m_1) - (m_5 - (m_6 - m_3))}{((m_2 - m_1) \cdot \text{TS}_{\text{md}}) \cdot 100 \cdot 100} \quad 13$$

ADF	Share of acid detergent fibre	% _{TS}
m_1	Mass of the empty dried Fibrebag	g
m_2	Mass of the dried Fibrebag with sample	g
m_3	Mass of the empty crucible of the blank reading	g
m_4	Mass of the crucible & Fibrebag & sample after drying	g
m_5	Mass of the crucible & Fibrebag & sample after calcination	g
m_6	Mass of the crucible & Fibrebag after calcination of the blank reading	g
TS_{md}	Total solids of the dried and milled sample	%

$$\text{ADL} = \frac{(m_7 - m_1) - (m_5 - (m_6 - m_3))}{((m_2 - m_1) \cdot \text{TS}_{\text{md}}) \cdot 100 \cdot 100} \quad 14$$

ADL	Share of acid detergent lignin	% _{TS}
m_7	Mass of the ADL-crucible & Fibrebag after drying	g

4.12 Determination of Neutral Detergent Fibre (NDF)

Michael Dittrich-Zechendorf, DBFZ

Status	The method is an in-house method that is carried out modelled after the prescribed method of VDLUFA, Book of Methods III, 2nd Supplement, Hamburg 1988 (VDLUFA 1988).
Associated standard	Determination of NDF, official method
Area of application of the method	For the determination of components insoluble in neutral detergent solution

By boiling the dried samples in neutral NDF solution, hemicellulose, cellulose, lignin and lignin-N-compounds are not eluted from the feedstuff. This undissolved residue is weighed out after drying and turned to ash. The difference between the ash content and the undissolved residue is referred to as neutral detergent fibre (NDF). Particular attention must be paid to the adherence to the pH value.

Devices and chemicals

- fibretherm FT 12 device, fibrebag (NDF) & accessories
- drying cabinet and Muffle furnace
- precision scale, crucible & desiccator
- NDF solution
- hexane
- aqua dist.

Preparation of the analysis

The samples must be ground to ≤ 1 mm and dried in the drying cabinet at 105 °C for approximately 24 h. Furthermore, for each sample a crucible must be calcined empty at 500 °C for 2 h. A double determination is carried out. In addition, corresponding to the number of samples, Fibrebags must be dried in the drying cabinet at 105 °C for 1 h.

Manufacturing of detergents for the NDF determination

Devices and chemicals

- 5 L volumetric flask
- 5 L & 1.5 L beaker
- glass funnel
- 50 mL volumetric bulb pipette
- top unit scale and small weighing bowl(s)
- magnetic stirrer with magnetic stir bar
- aqua dist.

- EDTA disodium salt (EDTA disodium salt dihydrate also possible) p. a.
- disodium tetraborate decahydrate p. a.
- dodecylsulphate sodium salt p. a.
- triethylene glycol p. a.
- sodium dihydrogen phosphate p. a.
- soda lye/sulphuric acid p. a.
- antifoaming agent (TANAFOAM 1573)

Manufacturing of the NDF solution

Approximately 2 L distilled water and a magnetic stirrer are placed in a 5 L beaker. 93 g (103 g EDTA disodium salt dihydrate) and 34 g disodium tetraborate decahydrate are transferred into the 5 L beaker. The solution is stirred on the stirring disk until all solids have been dissolved. Subsequently, 150 g dodecylsulphate sodium salt is added into the beaker in the same manner and 50 mL triethylene glycol are pipetted in while stirring.

Approximately 1 L distilled water is placed in a 1.5 L beaker and – while stirring until complete dissolution – 22.8 g sodium dihydrogen phosphate are added into the beaker: Thereafter, this phosphate solution in the 5 L beaker is filled up with distilled water to approximately 4.5 L and 2 mL of antifoaming agent is added. The pH value is measured and adjusted with soda lye/sulphuric acid to be between 6.9 and 7.1. The solution is transferred into the 5 L volumetric flask by means of the glass funnel and filled up to the calibration mark with distilled water. The shelf life of the solution is four weeks.

Execution of the analysis

Subsequent to the drying, the empty weight of the Fibrebags is determined (m_1) and approximately 1 g of dried sample is weighed in accurate to 0.1 mg. The mass of the Fibrebag filled with the sample is recorded (m_2). A glass spacer is carefully inserted into the Fibrebags and both together are placed in the sample carousel. All Fibrebags are thoroughly rinsed with hexane. This way, excess fat is eluated from the samples. After drying for approx. 2 min in the exhaust, the Fibretherm is started with the settings listed in Tab. 4.12-1.

Once the method has been completed, the spacer is removed from each Fibrebag, whereupon care must be taken that none of the samples are discharged. The Fibrebag is placed in the crucible rolled up and dried for approximately 24 h at 105 °C. Subsequent to the drying, it is left to cool down in the desiccator and the mass is determined. The ashing of the Fibrebags is carried out at 500 °C for at least 2 h. After cooling down in the desiccator, the samples are weighed. In addition, the dry matter of the analysis sample must be determined in order to be able to put the result in relation to the total solids.

Result calculation

$$\text{NDF} = \frac{(m_4 - m_1) - (m_5 - (m_6 - m_3))}{((m_2 - m_1) \cdot \text{TS}_{\text{md}}) \cdot 100 \cdot 100} \quad 15$$

NDF	Share of neutral detergent fibre	% _{rs}
m ₁	Mass of the empty dried Fibrebag	g
m ₂	Mass of the dried Fibrebag with sample	g
m ₃	Mass of the empty crucible of the blank reading	g
m ₄	Mass of the crucible & Fibrebag & sample after drying	g
m ₅	Mass of the crucible & Fibrebag & sample after calcination	g
m ₆	Mass of the crucible & Fibrebag after calcination of the blank reading	g
TS _{md}	Total solids of the dried and milled sample	%

Table 4.12-1: Method for the determination of NDF

1	Dosage	NDF solution	1.3 L
2	Heating	35%	1 h
3	Suctioning off		2 min/30 s
4	Washing cycle 1/2		
5	Washing cycle 2/2		
6	Dosage	H ₂ O wash	1.3L
7	Heating	55%	0 h 5 min
8	Cooling	91 > 60 °C	
9	Dosage	H ₂ O wash	1.3L
10	Heating	55%	0 h 2 min
11	Cooling	90 > 60 °C	
12	Method completed		

5 Methods for gas analysis

5.1 Measuring methods for determining gas flow in raw biogas

Robert Binder, Manuela Charatjan, Michael Krafzig, Binder Engineering GmbH

Status	The various methods had been developed and tested. They are established and already being used in process monitoring.
Associated standards	DIN 1343, DWA-M 264, DIN EN ISO 5167
Scope of the method	<ul style="list-style-type: none"> • Metrological recording of the gas quantity produced allows optimization of feeding cycles and thus management of gas storage facilities with load-dependent power feed into the electrical grid. • It can be used for official and statutory verification of the produced amount of biogas, <p>Precondition is the use of standardised reference variables, such as the standard volume.</p>
Measuring range and measuring point	<ul style="list-style-type: none"> • Sensors are available in different lengths and sizes, can be used in nominal widths from DN 25, there is no upper limit. • All typical measuring points including immediately downstream of the respective fermenter (main digester, secondary digester), downstream of the digestate storage tank, in the manifold, downstream of the gas cooler, upstream and downstream of the sulphur filter, upstream of the CHP plant and immediately upstream of the gas pretreatment/gas infeed can be used with thermal dispersion sensors, if there is no custody transfer equipment required. • Typical nominated gas speed range depends on the measuring point: <ul style="list-style-type: none"> ○ directly after the digester from 0.25 to 2 m s⁻¹ at very low gas pressure of 1–3 mbar only ○ in front of CHP stations 8–15 m s⁻¹ at higher gas pressure of 50–100 mbar ○ for biomethane at feeding points into natural gas grid 8–10 bar • Requirements on explosion protection for the devices must be taken into account.

Advantages

Advantages of the thermal dispersion measuring method are:

- The produced amount of gas in direct relation to the standard temperature and standard pressure according to DIN 1343 is determined.
- No pressure and temperature compensation of the signal is necessary.
- Moisture content needs to be compensated afterwards, it can be done by various technical means.
- It is especially suitable for measuring points immediately downstream of the fermenter. Due to its function principle, it yields very accurate readings even at low pressures and gas velocities.

Overview measuring methods

Unlike many other gases, raw biogas puts unusually high demands on the sensor for flow measurements, since the gas is wet and contains corrosive trace gases. In addition, the commonly used large cross-section gas piping at the fermenters means that the velocity can be close to zero at low gas production volumes, with a gauge pressure in the pipe of only a few millibars. Due to the nature of the process, the gas composition almost constantly changes as a result of changing substrate composition, feeding cycles and intermittent operation of the agitators. Many years of experience have been gained with flow meters in sewage sludge fermentation, whereby some points as the humidity and corrosion problems show a close concordance to practical biogas use.



Figure 5.1-1: Principle of vortex method (Source: ABB)

The current state of the art regarding suitable measuring methods that are also used in biogas flow measurement is published (DWA-M 264 2015). The best known are the vortex method, the ultrasonic method and the thermal dispersion method.

The volume of a certain mass of gas depends to a large extent on its pressure and temperature. The first two methods are limited to measure the biogas volumetric flow rate at operating pressure and temperature.

The vortex sensor measures only the volumetric flow rate. It has a solid body in the gas flow. Downstream to this body the gas flow breaks away. The frequency of the eddies is detected. A minimum gas speed is required to build up the eddies and high effort must be spent to detect low frequencies precisely.

Ultrasonic flow meters are typically of flanged version and measure only the volumetric flow rate. The transit time difference principle allows to detect the gas speed. Operator must take special pipe precautions for the case of repair. Accuracy of flow metering depends on the gas speed and is typically worse at low one.

To obtain comparative values, the reading (operating volume flow rate) must therefore be converted to a (mass-related) standard pressure and standard temperature. As basis, the conditions 0 °C, 101.325 kPa and 0% relative humidity are typically used (DIN 1343:1990-01). This requires an additional pressure sensor and temperature sensor. Total accuracy depends on accuracy of each of the three sensors.

In contrast, the thermal dispersion method allows the mass flow to be measured directly at standard pressure and standard temperature. It uses a heated resistance sensor and a reference sensor, both are positioned within the gas flow. The gas flowing past the heated sensor cools the sensor.

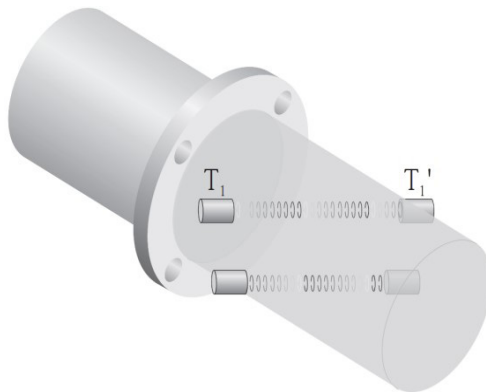

Figure 5.1-2: Principle of ultrasonic method (Source: Endress & Hauser)

Every passing molecule has a specific mass with a specific heat capacity and therefore removes a specific amount of heat (calorimetric principle). The maximum temperature difference between the two sensors, and therefore the maximum signal, occurs when the gas flow is zero. The higher the gas mass flow, the smaller is the temperature difference and therefore the signal level.

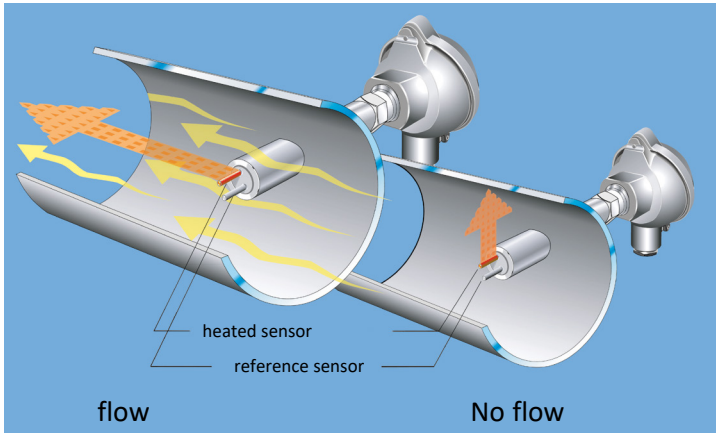

Figure 5.1-3: Principle of thermal dispersion method (Source: Binder GmbH)

This is a second key difference to the ultrasonic and vortex sensors, with which the signal level increases with increasing gas velocity. There is a minimum required flow velocity, which is often not reached at measuring points directly downstream of the fermenter or which results in incorrect readings.

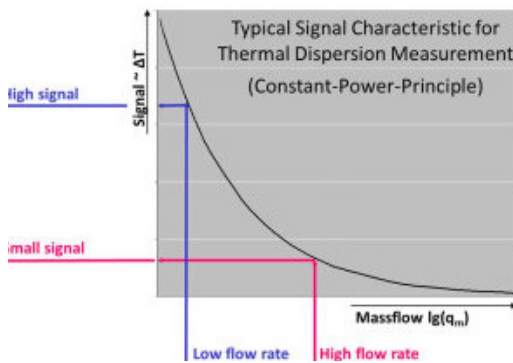

Figure 5.1-4: Signal level of thermal mass flow meter depending on gas flow rate (Source: Binder GmbH)

Influence of humidity

One problem common to all measuring methods: Biogas is humid at all points in the biogas plant, so that the condition of 0% relative humidity specified by DIN 1343 cannot be fulfilled. Furthermore, the humidity varies significantly. Immediately downstream of the fermenter, the biogas is water vapor saturated (100% rel. humidity). At a gas temperature of 37 °C, it results in a volumetric proportion of about 6% in the gas, i.e. all flow meters indicate values that are too high if the desired result is the standard volumetric flow rate or mass flow. As the gas temperature increases, the moisture content also increases exponentially (DWA-M 264 2015). Because the proportion of moisture at water vapor saturation depends on the gas temperature, it can be calculated and compensated as long as the gas temperature is known.

On a biogas plant, the gas is typically cooled and the resulting condensate separated. This reduces the moisture content along the flow path up to the point of processing. Prior to utilization in a combined heat and power (CHP) plant, the gas pressure is usually raised by a fan and slightly heated in the process. This reduces the relative humidity to below 100%, so that the gas is only partially saturated. The calculation formula can then no longer be applied. If a very accurate gas flow measurement is required, a moisture sensor must be used to determine the dew point temperature. The dew point is the temperature at which the gas would be water vapor saturated. With the equation and the dew point temperature, the proportion of moisture can also be calculated and compensated for the gas flow upstream of the CHP plant.

Influence of changing methane concentration/gas composition

The gas flow meters are usually supplied ready to use by their manufacturers, i.e. they are scaled and adjusted (colloquially: calibrated) for the expected installation scenario. In addition to the gas flow measurement range, the pipe routing, inner diameter and installation position (recommendation for humid gasses: fitted to the side of a horizontal pipe), the gas composition must also be taken into account when calibrating (a methane molecule removes a different amount of heat than a carbon dioxide molecule).

This will result in a deviation in the reading if the methane concentration varies. However, in biogas plants at steady operation this deviation is minor because the methane concentration fluctuates only about ± 1 to 3% vol. The gas humidity has a greater impact on the measurement signal.

During batch processing in solids waste treatment plants, on the other hand, the methane concentration fluctuates to a much greater extent. If an accurate gas flow measurement is required here, a combination of biogas analysis and a compensation of the gas flow signal by the current gas composition is unavoidable. A measurement in the manifold can be implemented easily, since the gases from all fermenter boxes are mixed here, thereby reducing the fluctuation in gas quality.

Influence of installation situation/piping details

The greatest influencing factor on measuring accuracy, however, is the installation position. The immersion sensor with its two sensor tips is typically positioned in the middle of the pipe. The flow profile at the installation location must be even and unaffected by other factors, such as vibration or pulsation. This necessitates a certain minimum distance from pipe fittings, such as bends, T-junctions, diameter reductions or expansions, shutters and control valves, as these affect the flow profile. Otherwise, deviations of 30% and more in the readings falsify the actual value.

The minimum inlet and outlet pipe sections required for highly accurate readings are published (DIN EN ISO 5167-1 2003). Acceptable accuracies (e.g. $\pm 2\%$ of the reading $+0.1\%$ of the full scale) for the various measuring methods are listed in DWA-M 264. A formation of condensation in the gas stream must be avoided as water droplets catching on the heated sensor will yield too high a value (normally full scale) until they are fully evaporated. Flow conditioners can reduce the required length of straight piping but require a minimum flow velocity to work and cause a corresponding pressure drop.

Summary

In summary, the suitability of the measuring methods for the various installation locations in a biogas plant can be described as follows: Devices using the thermal dispersion principle can be installed anywhere as long as the requirements for straight piping are fulfilled. They are superior to the other measuring methods, especially immediately downstream of the fermenters. They measure the gas flow directly at standard pressure and standard temperature. No signal compensation is required. At installation locations with water vapor saturation, the moisture content can be easily calculated and compensated based on the gas temperature. If a moisture compensation is to be performed in the gas flow upstream of the CHP station, a dew point sensor can be used. This sensor must work reliably over a long service life.

Vortex counters and ultrasonic sensors require a minimum flow velocity that is usually not available directly downstream of the fermenter. Their use at this location will result in significant measuring errors, but in front of CHP stations they can be used too.

5.2 Measuring methods for determining gas quality in raw biogas

Robert Binder, Manuela Charatjan, Michael Krafzig, Binder Engineering GmbH

Status	The method has been developed and tested. It is established and is already being used in process monitoring.
Associated standards	DIN 1343, VDI 3475
Scope of the method	<ul style="list-style-type: none"> • The metrological recording of the gas quality produced allows optimization of feeding cycles and thus management of gas storage facilities with load-dependent power feed into the electrical grid. • It can be used for official and statutory verification of the produced amount of biogas. • This knowledge can be applied to ensure reliable operation with minimized emissions (VDI 3475).
Measuring range and measuring point	<ul style="list-style-type: none"> • Gas can be sampled at any point in the biogas plant and then routed to the analyzer station through hoses or permanently installed stainless steel pipes, • Alternatively, acceptable results can be achieved with mobile hand-held devices, if they are properly used. • If measurements with hand-held devices are carried out outdoors directly at the fermenter or near gas pipes, the design of the hand-held device must be explosion-proof. • Measuring cells with different measuring ranges exist for each gas component. • The measuring accuracy generally depends on the full scale of the cell, a suitable measuring method and range must be chosen. • CH₄ and CO₂ are typically analyzed using NDIR technology • O₂, H₂S, H₂ and NH₃ are typically analyzed using electrochemical cells. • To ensure accurate readings, pressure- and temperature-compensation needs to be integrated (H₂S cells must be protected additionally against overload). • Suitable gas pre-treatment units (e.g. gas cooler, coalescence filter, flaming arrestors) protect the analyzer from soiling and moisture.

Advantages	<ul style="list-style-type: none"> ● Knowledge of the current gas composition helps in monitoring the fermentation processes. ● Analysis is also used to monitor the quality of the gas prior to its use, e.g. to reduce the strain on machines and power units (Sulphur content) or to help set the ideal operating point (methane content) to increase the CHP's efficiency. ● Where air is injected into the fermenters or the Sulphur filter, a gas analysis can be used to monitor the raw biogas for oxygen to prevent an explosion-prone gas mixture.
Disadvantage	<ul style="list-style-type: none"> ● Unlike the use of gas flow meters, analysis methods are always associated with regular maintenance of the gas cells and other parts in the analyzer, such as pumps and valves. ● Through recalibration, occurring measurement drift can be compensated within certain boundaries as long as wear is not yet too advanced. ● cross-sensitivities of the electrochemical measurement to other gas components must be avoided by the use of a suitable electrolyte solution, or else the signal must be compensated.
Further benefit	<ul style="list-style-type: none"> ● Coupling of the analysis with flow meter can improve the accuracy of the biogas flow readings through signal compensation based on the current gas composition. ● Especially in plants in which the gas composition varies significantly – for example in solids waste digesters, mechanical-biological waste treatment and co-digestion plants the fluctuation in gas composition is much greater than in wet fermentation plants, especially if a high measuring accuracy is required. ● Coupling of the analysis with biogas flow meters allows an energy content calculation of the biogas flow. ● Because custody transfer flow meters for biogas with varying gas composition are not available on the market, the sale of raw biogas can be invoiced only based on its energy content (unless the gas quality corresponds to natural gas after a biogas upgrade plant). ● A particularly high accuracy and long-term stability of readings can be realized through suitable measures in these cases (e.g. permanent connection of a testgas bottle and auto-calibration of gas cell on a regular time base).

Details of NDIR method

The typically used measuring methods for determining biogas quality are NDIR (non-dispersive infrared absorption) for CH₄ and CO₂ concentrations and electrochemical methods for O₂, H₂S, NH₃ and H₂.

The non-dispersive infrared measuring principle is particularly suitable for analyzing gas mixtures containing CH_4 and CO_2 . Here, the gas is channeled through an optically accessible measuring chamber. The infrared sensor emits light of a known spectrum and intensity through the measuring chamber. The detector on the other side of the chamber receives the remaining light. The gas molecules in the measuring chamber absorb a particular wavelength depending on the gas constituent. With an increasing concentration in the gas the intensity at the receiver is decreasing accordingly.

The wavelengths of CH_4 and CO_2 as well as water damp differ significantly. Therefore, these components can be measured very well with the NDIR method even in one gas chamber with an adjusted length.

Some hydrocarbons, such as methane, ethane and propane, absorb light of the same or similar wavelengths. In these cases, with overlapping spectra, the concentration of the individual constituents cannot be determined by a single wavelength measurement unless the evaluation is performed with secondary signals. Thus, mixtures of biogas and natural gas cannot be analyzed readily, as further measures are required.

Details of electrochemical method

An electrochemical cell consists of a measuring chamber that contains two or three electrodes and is filled with an ion-conducting electrolytic solution. On the outside, a diaphragm is fitted, which allows the gas to be analyzed to pass into the measuring chamber and to the working electrode. There, the gas component is electrochemically converted so that electrons flow to the counter electrode. The resulting electrical current is proportional to the amount of gas converted at the working electrode and therefore to the concentration of the constituent in the gas. The electrolyte solution as a consumable depletes over time.

The reference electrode maintains a constant voltage between the working and counter electrode. The voltage level is specific to the gas as well as the electrodes' materials and the electrolytic solution, which are chosen specifically for each gas to optimize selectivity and minimize cross-sensitivities.

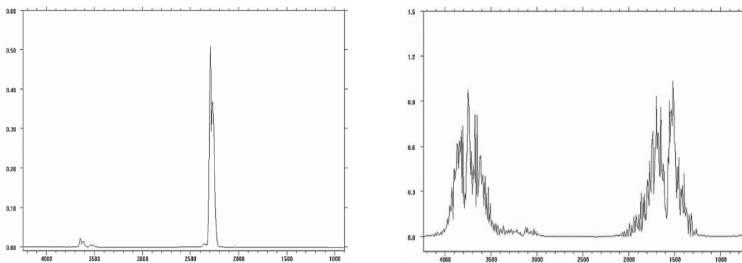

Figure 5.2-1: IR spectra of CO_2 and water vapor (from left to right) (Source: ANSYCO)

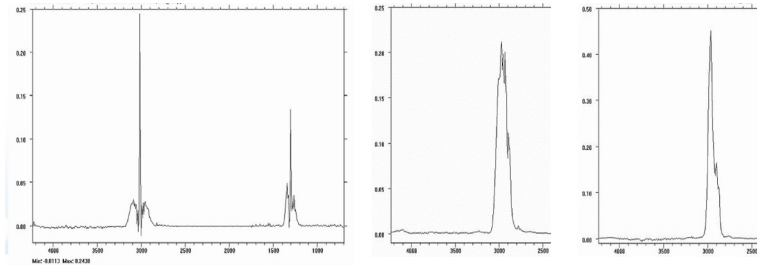

Figure 5.2-2: IR spectra of methane, ethane and propane (from left to right) (Source: ANSYCO)

Some electrolyte solutions, e.g. in H_2S gas cells require additional oxygen. If there is not enough oxygen in the gas, the affected constituent can only be measured periodically, and sufficient oxygen can be made available by intermediate flushing with air.

If the pipe length between gas sampling point and installation location of the analyzer station are long, it must be ensured that the gas being analyzed is current (long lead times) and that enough oxygen remains in the cell to yield an accurate reading.

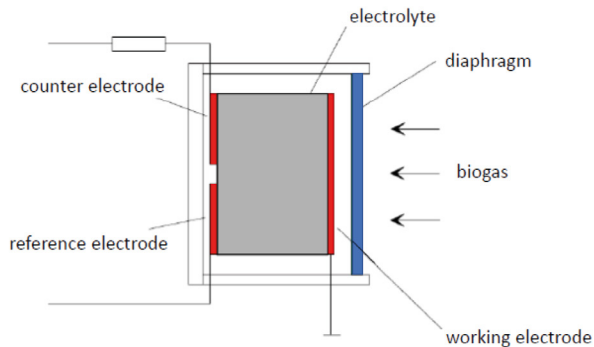

Figure 5.2-3: Schematic representation of an electrochemical cell (Source: Binder GmbH)

Cross-sensitivity

When measuring ammonia, cross-sensitivities are particularly pronounced if the gas contains H_2S (which is usually the case). If ammonia is to be measured accurately, the H_2S concentration must be measured at the same time and the NH_3 signal corrected accordingly.

The general data in the manufacturer's data sheet can be used for this purpose. Alternatively, the cross-sensitivity of each cell itself can be determined in a test installation, which yields a more accurate result but is also more expensive.

Measure for high long-term accuracy/service

Gas cells are usually scaled and calibrated to the biogas plants by the manufacturer before delivery using test gas. To be precise, the stated accuracy therefore represents a repetition accuracy. The cell manufacturers' accuracy data typically relates to the full scale of the cell and not to the measured value (reading). The ageing of the electrochemical cells due to electrolyte consumption leads to a measuring drift, which can be corrected through recalibration. Using a test gas of known composition and as long as wear is not too advanced, accuracy can be kept. IR measuring cells do not experience this kind of wear, but are prone to contaminants in the biogas that can accumulate in the measuring cuvette, if the particle filter in front is not replaced in time. Due to the optical evaluation principle, this can result in measuring errors. The service life of the IR diode must also be observed. The gas sensors require regular calibration (VDI 3475 2010).

Mobile analyzers can be easily tested with test gas in the laboratory, provided the manufacturer has made calibration menus accessible for external labs. Test and recalibration of analyzer stations is generally more complicated unless they are equipped with a test gas inlet and a calibration function as standard equipment. For normal accuracy requirements, a manual calibration function operated via menus on the graphic display is sufficient. If a much higher accuracy is required due to the nature of the project or because of a very high measuring frequency, a permanent connection of test gas cylinders to the analyzer station and an automatic calibration function that runs at fixed time intervals is recommended.

In general, an analyzer station should be designed such that typical spare and wear parts can be easily replaced on site. No manufacturer has a service station in every country to be able to provide cost-effective on-site service at close proximity to the customer. Returning devices to the manufacturer for recalibration or servicing and operating the plant without instrumentation in the meantime would be inconvenient and expensive for the operator.

Sampling points and frequency of use

Regarding the question, which gas component should be measured at which point, the VDI GUIDELINE "Emission control – Agricultural biogas facilities" (VDI 3475 2010) can be consulted: This guideline urgently recommends to analyze the composition of the biogas for methane, hydrogen sulphide and oxygen both in its raw state and upstream of the CHP plant at least once a day. This allows changes in the biogas and correct functioning of the cleaning measures to be monitored. If the substrate composition changes or if the feed is not constant over time, resulting in variations in the gas composition, the cycle times must be adjusted.

Removing H₂S upstream of the CHP unit not only protects the plant's components against corrosion and extends oil change intervals; it also reduces SO₂ emissions in the exhaust gas. Special requirements regarding gas quality (< 20 ppm H₂S) and therefore function

monitoring of the filters apply where oxidizing catalytic converters are used, which would become toxic at higher concentrations or corrode due to Sulphur trioxide. In these cases, gas cells with suitably small measuring ranges must be used to be able to measure the low concentrations reliably and with sufficient accuracy. These measuring cells must be protected against overload through filter penetration in the analyzer station.

Combination of gas flow measurement and analysis

Coupling the analysis with biogas flow meters can improve the accuracy of the biogas flow readings through signal compensation based on the current gas composition. Especially in plants in which the gas composition varies significantly – for example in solids waste digesters, mechanical-biological waste treatment and co-digestion plants – the fluctuation in gas composition is much greater than in wet fermentation plants. In these cases, coupling makes sense especially if a high measuring accuracy is required.

Coupling the analysis with biogas flow information allows a calculation of the energy content of the biogas flow. Because custody transfer flow meters for biogas with varying gas composition are not available on the market, the sale of raw biogas or feed into small local biogas grids can be invoiced only based on its energy content (unless the gas quality corresponds to natural gas after a biogas upgrade plant).

A particularly high accuracy and long-term stability of readings can be realized through suitable measures in the following cases:

- The installation of the flow meter in a spooling piece of pipe reduces the effects by insufficient straight inlet pipe length and disturbed flow profile.
- Use of a special hot tapping unit for the flow meter, to keep insertion depth and sensor orientation
- A special calibration of the flow meter with higher number of measuring points increases measuring accuracy.
- CH_4 is continuously analysed in the analyzer cabinet.
- A test gas bottle with precisely formulated test gas for auto-calibration of the gas cell is permanently connected.
- Flow signal based on pipe diameter, gas speed and actual CH_4 concentration in the gas (after basic investigation of all these influences in a closed calibration loop) are permanently corrected.
- Energy contents based on actual (compensated for humidity and CH_4 deviation) flow and CH_4 -concentration are calculated.
- Further requirements/recommendations are plausibility check of flow and concentration, further measures for manipulation-safe installation of the flow meter, use of an uninterruptible power supply (to send out an alarms if power supply is interrupted), use of a redundant gas pump (in case of fail), data transmission not only to the local main PLC but also to central data center.

Summary

In summary, biogas analysis places higher demands on the equipment, monitoring of wear and required service compared to gas flow metering.

Monitoring the gas composition can detect early process malfunctions based in substrate composition or feeding/load failures, respectively.

The combination of gas flow and gas composition can be used for calculation of energy content in the gas stream. If biogas shall be sold and since custody transferred flow meters are not available for this application, specially designed measuring systems can be used to determine the energy content in the gas with accuracies better than 3%.

5.3 Sampling and measurement of siloxanes

Ute Merrettig-Bruns, Bettina Sayder, Edda Möhle, Fraunhofer Institute for Environmental, Safety, and Energy Technology UMSICHT

Status	The method was tested and good results were achieved, but further validation of the method is still needed
Standard	The method depends on DIN EN ISO 16017 1 (“Sampling and analysis of volatile organic compounds by sorbent tube/thermal desorption/capillary gas chromatography – Part 1”).
Area of application	The method can be applied during biogas sampling.
Advantages	Long storability of samples (samples are stable for several weeks when refrigerated), good handling, easy sampling, short sampling duration, no solvents needed during sampling
Need for research	Further validation of the method in field tests is required.

In the context of biogas upgrading and biogas utilization processes volatile organic compounds like volatile organic silicon substances (siloxanes) are the source of various problems. While Trimethylsilanol (TMSOH) is probably formed during the anaerobic fermentation of siloxanes or long-chain silicones, siloxanes are hydrophobic chemical compounds with low water solubility, offering useful properties (e.g. thermal stability, surface activity, hydrophobicity) for several applications. For instance, siloxanes can be found as ingredients in consumer products such as shampoos or cosmetics. Furthermore, they are also used in various industrial processes, for example as anti-foam agents. However, siloxanes induce several problems in the energetic use of biogas. Herein, the gas engines can be seriously damaged due to formation of silicon dioxide from siloxanes and TMSOH during the combustion of biogas. Nowadays, varying methods exist for sampling and analyzing volatile silicon components. The method described below shows an adsorptive technique using Orbo tubes filled with a special polystyrene phase.

Devices and chemicals/aids

- gaschromatograph: Agilent Technologies GC 6890 N with MS 5975 B
- tubes: Orbo tubes Supelco ORBO 1103 Poropak Q 150/75 mg, Fa. Restek
- ultra-sonication

Reagents

- hexaethyldisiloxane (HEDS), CAS 994-49-0, alfa aesar, 99 %
- trimethylsilanol (TMSOH), CAS 1066-40-6, sigma-aldrich, 98.5 %
- hexamethylcyclotrisiloxane, (D3), CAS 541-05-9, sigma-aldrich, 98 %
- octamethylcyclotetrasiloxane, (D4), CAS 556-67-2, sigma-aldrich, 98 %
- decamethylcyclopentasiloxane, (D5), CAS 541-02-6, sigma-aldrich, 97 %

- dodecamethylcyclohexasiloxane, (D6), CAS 540-97-6, sigma-aldrich, 99 %
- hexamethyldisiloxane, (L2), CAS 107-46-0, sigma-aldrich, 98 %
- octamethyltrisiloxane, (L3), CAS 107-51-7, sigma-aldrich, 98 %
- decamethyltetrasiloxane, (L4), CAS 141-62-8, sigma-aldrich, 97 %
- dodecamethylpentasiloxane, (L5), CAS 141-63-9, sigma-aldrich, 99.6 %
- n-heptane, CAS 142-82-5

Sample preparation

Before sampling, the Orbo tubes are spiked with 100 μL ISTD (0.2 g L^{-1} HEDS in heptane) and closed with caps until sampling starts. To avoid breakthrough of the siloxanes, two tubes are connected in series. After sample collection, the contents of the two tubes are transferred into two separate headspace vials, each extracted 15 min by ultra-sonication with 2 mL heptane. Next, an aliquot of the heptane extract is analysed by GC-MS. Testing the efficiency of the extraction, orbo tubes are spiked with defined concentrations of a siloxane mixture and ISTD and are analyzed as described before.

Calibration

The concentration of the calibration standards range between 0.1–100 mg L^{-1} . The concentration of the internal standard ISTD (HEDS) is 10 mg L^{-1} .

- ISTD stock solution I1: 10 g L^{-1} in heptane (0.1 g in 10 mL)
- ISTD stock solution I2: 0.2 g L^{-1} in heptane (1 mL of I1 in 50 mL)
- 100 μL I2 dissolved in 2 mL heptane corresponds to 10 mg L^{-1} HEDS
- Siloxane mixture stock solution: 1 g L^{-1} in heptane (0.01 g of each siloxane in 10 mL)
- Siloxane mixture solution: 10 mg L^{-1} in heptane (100 μL of siloxane stock solution to 10 mL)

A nine-point calibration curve is prepared using siloxane mixture stock solution and siloxane mixture solution with the following concentration levels of the single compounds: 0.1 – 0.25 – 0.5 – 1 – 2.5 – 5 – 10 – 50 and 100 mg L^{-1} . Each calibration solution is spiked with ISTD HEDS (500 μL ISTD solution I2).

The internal standard-normalized response ratios for the siloxane compounds were linear from 0.1 to 100 mg L^{-1} with a correlation coefficient (R^2) \geq 0.998. Samples with concentrations lower than 10 mg L^{-1} are quantified over a calibration curve between 0.1–10 mg L^{-1} with the detection limit of 0.1 mg L^{-1} as the lowest calibration point.

Analysis

Siloxanes are analyzed using an Agilent 6890 N GC coupled with MS 5975 B. Under optimum GC conditions, an aliquot of extract (0.5 μL) was injected into the GC inlet operating split mode (5:1, split flow 10 mL min^{-1}) at an initial pressure of 2.6 bar and temperature of 200 °C. Helium was used as a carrier gas at a constant flow rate of 1 mL min^{-1} . Further, a DB Wax column (60 m x 0.25 mm x 0.5 μm) was used and the samples were analyzed using the following temperature program: 90 °C for 5 min, 90–230 °C at 15 °C min^{-1} .

A quadrupole mass spectrometer with an electron impact (EI) ionization source (70eV) was used. The MS source and MS quadrupole were maintained at 230 °C and 150 °C, respectively. The GC-MS data were acquired in selected ion mode. Retention times for each analyte, molecular ions, and major fragment ions used for compound identification are summarised in Tab. 5.3-1. The target molecules were identified by comparison of retention time, molecular ion peak, and major fragment ions with those of the corresponding standards. For quantitation purposes, analyte responses were normalized to the response of internal standard (HEDS).

Table 5.3-1: Retention time, Target ion and Qualifier ion of siloxanes

	Retention time (min)	Target ion (m/z)	Qualifier ion (m/z)
HEDS	9.28	189	161
TMSOH	5.68	75	45
L2	3.28	147	73
L3	3.60	221	73
D3	3.81	207	96
D4	4.31	281	265
L4	4.59	207	295
D5	5.83	355	267
L5	7.27	281	147
D6	8.46	341	73

Nine-point calibration curves were used in quantification. The instrument detection limit (IDL) for the target analytes is the lowest calibration point at 0.1 mg L⁻¹ (Fig. 5.3-1).

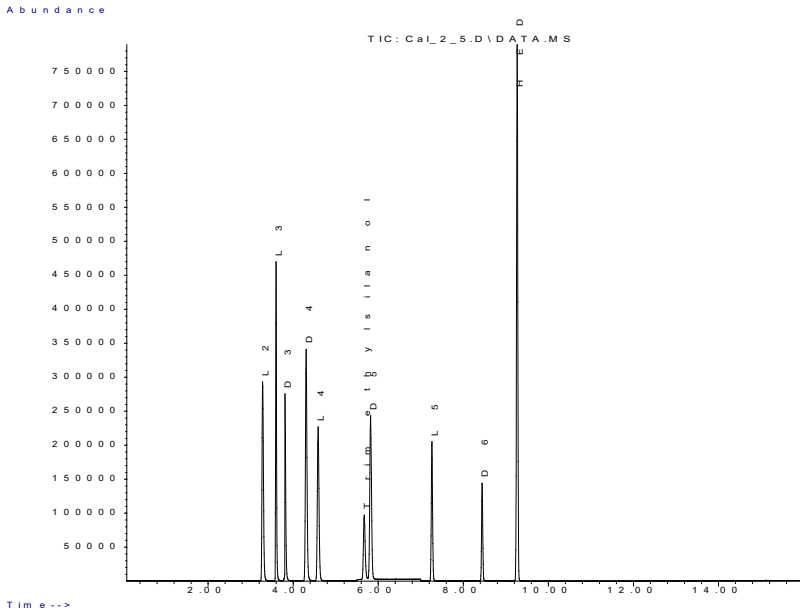

Figure 5.3-1: Chromatogram for standard solution, concentration 2.5 mg L^{-1} (Source: Fraunhofer UMSICHT)

The concentration of the gas sample (c_{Analyt} in mg m^{-3}) is calculated based on Eq. (18).

$$C_{\text{Analyt}} = V_{\text{Elution}} \cdot \frac{C_{\text{GCMS}}}{V_{\text{sample}}}$$

18

C_{Analyt}	Concentration of gas sample	mg m^{-3}
C_{Analyt}	Detected concentration by GC-MS	mg L^{-1}
V_{Elution}	Elution volume	L
V_{Sample}	Sample gas volume	m^3

Device parameters

Gaschromatograph Agilent Technologies GC 6890 N with MS-5975:

- injection volume: 0.5 μL split 5:1
- column: J&W 122-7063 DB Wax 60 m x 0.25 mm x 0.50 μm
- run-time: 90 °C, 5 min hold, 15 °C min^{-1} to 230 °C, 2 min hold,
runtime: 16.33 min
- carrier gas: helium
- flow: const. flow 1 mL min^{-1}
- MS: SIM-Mode
- EM-voltage: +200

Execution method

For the sampling step, two adsorption tubes loaded before with an internal standard are serially connected and placed into the sampling side stream for a few minutes. The tubes are flushed with a defined volume of sample gas and kept cool afterwards. Depending on the gas volume to be drawn, a pump, a mass flow controller (MFC) or a gas sample bottle may be used. After completing the entire sampling, the Orbo tubes are eluted with heptane and the obtained eluate is analyzed by GC-MS (Fig. 5.3-2). Typical sampling durations are between 2 min and 10 min, with flow rates between 100 and 1400 mL min^{-1} . The determination limit depends on the smallest calibration standard and the sample volume taken.

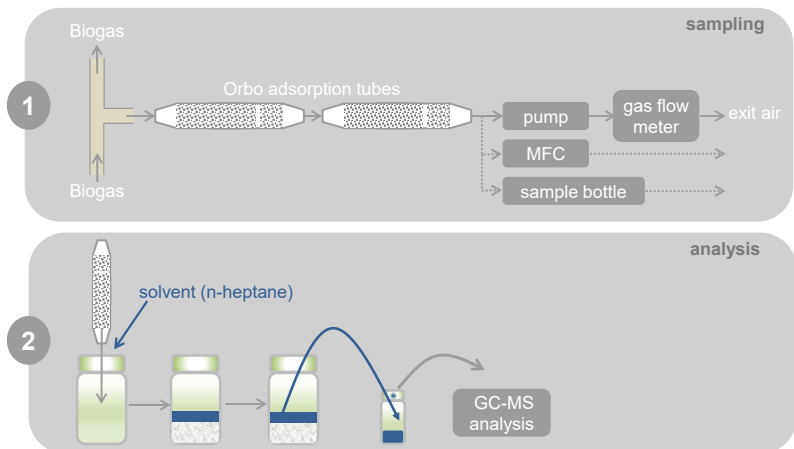

Figure 5.3-2: Sampling and analysis (Source: Fraunhofer UMSICHT)

To check the efficiency of this method a sampling was performed with a gas mixture of defined concentrations of different siloxanes in Methane (CH_4) as shown in Tab. 5.3-2. The total content of silicon was 15.7 mg m^{-3} .

Table 5.3-2: Composition of specifically constructed first test gas cylinder (CH₄)

Organic silicon compounds	Theoretical concentration in the first test gas cylinder [mg Si m ⁻³ CH ₄]
TMSOH	2.5
L2	2.2
D3	2.7
L3	2.2
D4	1.7
L4	2.5
D5	1.9
Total Silicon	15.7

The samples were taken with a mass flow controller (MFC) for a period of three and six minutes, respectively. The results showed that about 90% of the total silicon content were found using this procedure. However, a component-specific match was found only partially. The determined amount of components was in the range of 64–109% with TMSOH as lowest and L2 as highest value (Fig. 5.3-3). All values of the second tubes were below the determination limit of 2 and 1 mg m⁻³ respectively.

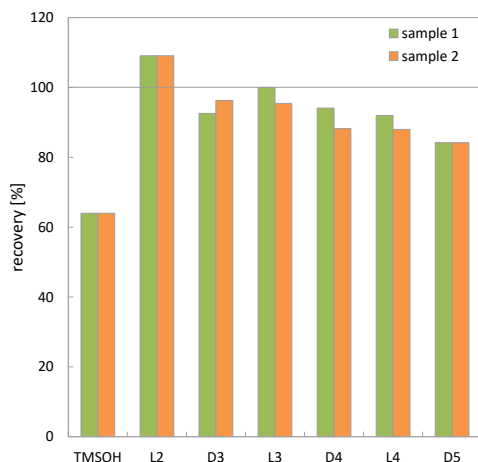

Figure 5.3-3: Sampling and analysis (Source: Fraunhofer UMSICHT)

A second test gas cylinder was filled with siloxanes and Nitrogen (N₂). The composition of the second test gas cylinder is shown in Tab. 5.3-3.

Table 5.3-3: Composition of specifically constructed second test gas cylinder (N₂)

Organic silicon compounds	Theoretical concentration in the second test gas cylinder [mg Si m ⁻³ N ₂]
TMSOH	2.0
L2	4.5
D3	6.7
L3	6.7
D4	8.9
L4	8.9
D5	11.0
L5	11.1
D6	13.2
Total Silicon	73.0

The first two samples were taken with a mass flow controller (MFC) for a period of nine and three minutes, respectively. Sample 3 and sample 4 were taken with a water-filled sample bottle (1000 mL) which was connected to the tubes. The defined volume of water was drained over a period of about 4 minutes. This caused a vacuum, which drew the gas through the tubes. The recovery rate decreases with increasing molecular size (Fig. 5.3-4).

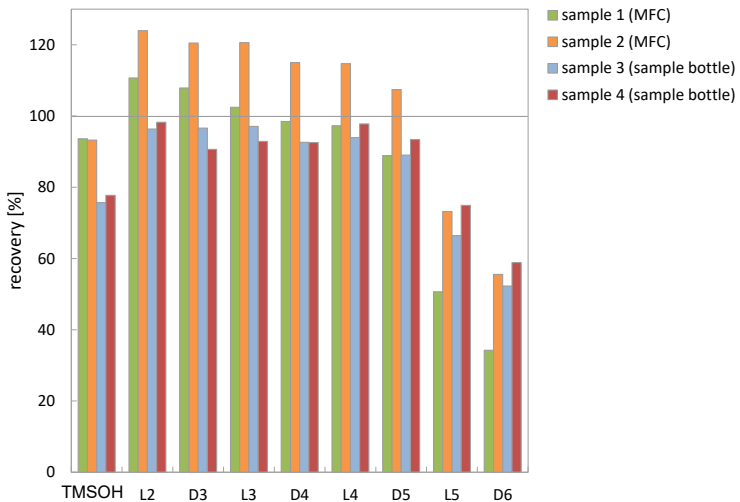

Figure 5.3-4: Results of sampling at the second test gas cylinder (Source: Fraunhofer UMSICHT)

The average recovery rates of total silicon were 87 %, 103 %, 85 % and 86 % for sample 1, 2, 3 and 4, respectively. The measured values for the two tubes connected in series for the four samples are shown in Tab. 5.3-4. For most of the second tubes the measured values were below the determination limit of 0.1 mg m^{-3} .

Table 5.3-4: Concentration of siloxanes in the first and second in series connected tube

Organic silicon compounds	Concentration [mg m^{-3}]							
	Sample 1.1	sample 1.2	sample 2.1	sample 2.2	sample 3.1	sample 3.2	sample 4.1	sample 4.2
TMSOH	4.9	1.1	4.9	1.1	3.9	1.0	3.9	1.0
L2	14.2	0.2	15.6	0.5	12.3	0.2	12.5	0.2
L3	19.2	< 0.1	22.6	< 0.1	18.2	< 0.1	17.4	0.2
D3	19.0	< 0.1	21.3	< 0.1	17.0	< 0.1	16.0	< 0.1
D4	23.2	< 0.1	26.8	0.2	21.8	< 0.1	21.3	0.4
L4	23.9	< 0.1	27.8	0.3	23.1	< 0.1	23.4	0.6
D5	25.8	< 0.1	30.9	0.3	25.9	< 0.1	26.5	0.6
L5	15.4	< 0.1	21.9	0.3	20.0	0.2	22.2	0.6
D6	11.9	< 0.1	19.1	0.2	18.2	< 0.1	20.0	0.5

Additionally, a field test with two samples was performed at a wastewater treatment plant. The first sample was taken for a period of four minutes, the second sample for two minutes and the third sample for two minutes. The obtained results are shown in Fig. 5.3-5. The measured values were about $0.14\text{--}10.3 \text{ mg m}^{-3}$ with L3 as lowest and D5 as highest value. The standard deviation was for L3, D4, L4 and D5 in the range of 0.8–9.7 %, for L5 about 29 % and for D6 about 34 %, related to the mean value. L2, D3 and TMSOH were not detected. All values of the second tubes were smaller than 0.05 mg m^{-3} . In conclusion, the field tests using our adsorptive sampling technique with Orbo tubes showed very promising results. The advantages of this methodology are long storability of the sample tubes, good handling and a short sampling duration. Furthermore, no solvents are needed during sampling.

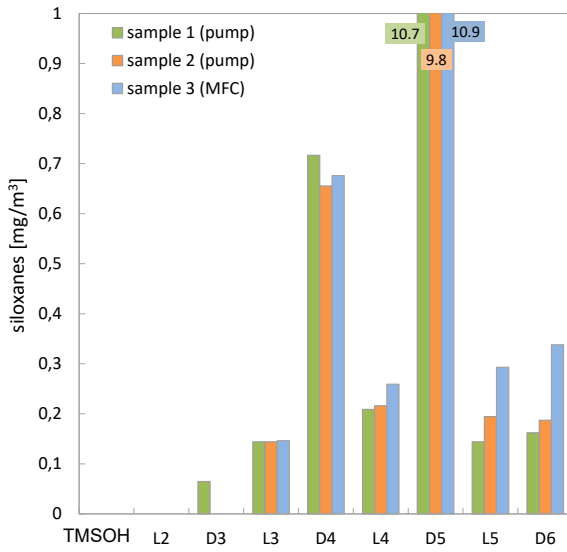

Figure 5.3-5: Results of sampling at a wastewater treatment plant (Source: Fraunhofer UMSICHT)

5.4 Determination of methane emission potential of liquid manure during storage at ambient temperature

Britt Schumacher, Walter Stinner, Katrin Strach, DBFZ; Thomas Amon, ATB

Status	The storage test stand and the practical implementation has been applied successfully in a research project with liquid cattle manure. The method of data evaluation is under development and highly dependent on the focus of the study.
Associated Standard	VDI GUIDELINE 4630 (2016)
Substrates	The method is applicable for liquid manure or slurries, which tend to form methane during storage without inoculum. An application for solid manure would be conceivable in principle, but has not been tested yet.
Limitations of the method	The long-term test takes time (several months) and the amount of substrate (approx. 500 kg) is high. Automatic measurements keep the personnel capacities low.
Advantage	Easy applicable and more controlled framework conditions compared to measurements in full scale on slurry lagoons, ponds or large open tanks with at the same time relatively realistic conditions concerning ambient temperature. The long measuring period gives more insight on the manure's emission behaviour over time than short campaigns as applied in method 5.5 by Cuhls et al. and method 5.6 by Westerkamp et al.. This storage method can be conducted supplementary to the aforementioned methods. The method is expandable to other emissions than methane emission.
Need for research	Application for other slurries and solid manure etc., correlation of this method and full scale storage, efficient data evaluation
Necessary sample preparation	A treatment of the sample would influence the results and should be avoided.
Sample quantities	Approx. 500 L
Special characteristics	<p>Safety note: All gas outlets behind gas meter and gas analyzer should be connected with hoses to lead the gas out of the room and into the open air due to safety reasons (danger of suffocation, danger of explosion, due to high amounts of gas)! Beside biogas, hydrolysis gas can also be produced.</p> <p>If possible, the gas should be collected and used (e.g. burned) due to climate reasons. However, the emitted gas is the same amount, which would be emitted during usual storage.</p>

During storage of liquid manure in stables, ponds, lagoons, or large open tanks often biogas (including methane) is formed. It is assumed, that the emission potential and the usable energetic potential of manure varies in dependency of the manure's composition. Depending on temperature profile during storage and storage time degradation takes place and occurring emissions (if not collected and used) reduce the usable energetic potential of the manure. Furthermore, no matching correlation between these potentials could be described, due to the different framework conditions of simple storage on one hand and controlled anaerobic digestion with suitable inoculum on the other hand.

Hence, the methane emission potential of manure during storage at ambient temperature as well as the biochemical methane potential at 39 °C and the methane emission potential at 20 °C are tested by means of this methodology at selected times during storage (aging) of liquid manure.

The aim of manure storage test at ambient temperature is to get an insight as realistic as possible on the manure's emission behaviour over long times during the seasons. The flanking biochemical methane potential at 39 °C and methane emission potential at 20 °C at defined temperatures and intervals enable comparisons of different samples from one manure over the time and also between various slurries.

Devices and chemicals/aids

The following equipment for the test stand was used:

- 8 x 120 L gas-tight barrels (filled to 50% with liquid manure to avoid foam in gas hoses)
- insulation material
- 5 temperature sensors (PT 100 Almemo) including data-logger Almemo 2590-9 V5 (Ahlborn Mess- und Regelungstechnik GmbH, Holzkirchen, Germany)
- 4 gas meters drum-type gas meter TG05/5 (Dr.-Ing. RITTER Apparatebau GmbH & Co. KG, Bochum, Germany)
- biogas analyzer (CH₄, CO₂, H₂S; Biogas-Analysator BM2000, Ansyco GmbH, Karlsruhe, Germany), a hydrogen sensor is advisable
- storage room with ambient temperature (garage)
- scale for up to 150 kg
- eudiometers for methane emission potential test at 20 °C
- AMPTS-device (Bioprocesscontrol, Lund, Sweden) for Biochemical methane potential test at 39 °C
- freezer (-20 °C) for storing the manure samples for BMP-Test
- equipment for associated analytics: total solids (TS, dry matter), volatile solids (VS, organic dry matter), pH-value, total ammonia nitrogen (TAN), volatile organic compounds (VOC); (see sections 3 Methods for the determination of fundamental parameters and 4 Methods for the determination of chemical parameters)

Sampling of cattle manure

The cattle manure was gathered from a stable's collecting pit, which was stirred three times a day and emptied every day. Hence, only fresh manure was collected. The liquid manure was taken out of the pit with a 5-L-ladle. The manure was put into 10 x 60 L plastic barrels for transportation from the stable to the storage test stand, which was filled with the manure at the same day. The barrels for transport were equipped with gas outlets in the lids to avoid overpressure due to the formed biogas.

The first sampling took place in May after the winter season's, when manure tanks are usually completely depleted and only fresh slurry is stored. It was assumed that an additional sampling in October and investigating of fresh liquid manure for the winter season shows the minimum emission in comparison to the maximum emission from the May-sample because of the varying ambient temperature.

Method execution

The method consists of three tests.

Test	Temperature/Inoculum	Duration
Manure storage test stand (barrels) = methane emission potential test	Ambient temperature, without inoculum	Summer sample 40 week, winter sample 20 weeks
Methane emission potential test (eudiometer)	20 °C, without inoculum	60 days
Biochemical methane potential test (AMPTS)	39 °C, with inoculum	Test termination criterion: < 0.5% new gas formation/3 day

The storage test began after the determination of sampling date (considering seasonality and representativity), sampling and transport. Sample preparation and treatment were avoided to keep the conditions realistic.

The fresh sample was analyzed concerning total solids (TS), volatile solids (VS), pH-value, total ammonia nitrogen (TAN), and volatile organic compounds (VOC). The weight of the barrels at the beginning and end of the storage as well as the empty weight of the barrels was determined for a mass balance.

The emission potential (20 °C, without inoculum) of the fresh sample was analyzed immediately over 60 days (VDI 4630, 2016), further details see below. A sample for biochemical methane potential (BMP) (39 °C, with inoculum) was stored in a freezer (-20 °C) until the end of the whole storage test after 40 weeks to investigate the sample from the start together with all following samples (interval of 10 weeks) with the same inoculum.

Manure storage test stand (barrels) – methane emission potential test at ambient temperature

For the storage 8 x 120-L-barrels were used, 4 of the 8 gas-tight barrels were equipped with 3 sockets (2 for gas meter and gas analyzer, 1 in the middle for the temperature sensor). One additional temperature sensor measures the air temperature in the not air-conditioned storage room (garage). Fig. 5.4-1 shows the piping and instrumentation diagram of the manure storage test stand separately for summer and winter sample, each at starting time. All temperature sensors have been connected to a data logger. The other 4 barrels had one gas outlet, which was connected to a second barrel (pairs of barrels, see Fig. 5.4-1).

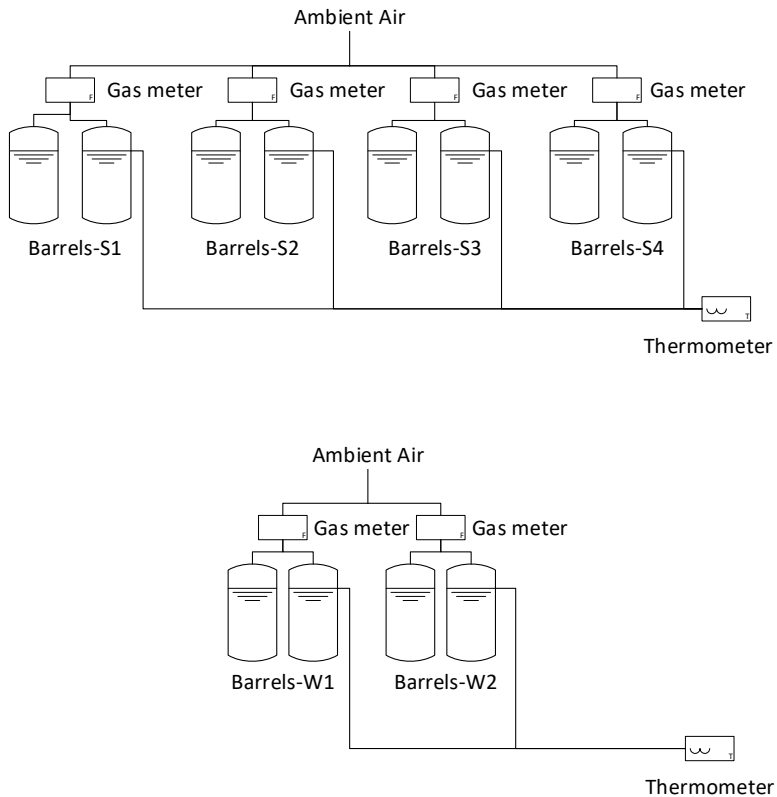

Figure 5.4-1: Piping and Instrumentation Diagram of the manure storage test stand (Source: DBFZ Masula)



Figure 5.4-2: Manure storage test stand (Source: DBFZ 2018)

The temperature was measured automatically every hour. The gas quantity and quality were determined manually on a daily base during the first weeks and later on a weekly base. Fig. 5.4-2 gives an impression of the manure storage test stand at ambient temperature at DBFZ.

Safety note: All gas outlets behind gas meter and gas analyzer should be connected with hoses to lead the gas out of the room and into the open air due to safety reasons (danger of suffocation, danger of explosion, due to high amounts of gas)! Beside biogas, hydrolysis gas can also be produced.

The barrels were filled with the liquid cattle manure in May. The weight of the barrels at the beginning and at end of the storage as well as the empty weight of the barrels were determined for a mass balance. The storage of one pair of barrels have to be finished and samples have to be taken and analyzed with an interval of 10 weeks as explained for the sample at the begin, Fig. 5.4-3. The sampling mode of 10 week should ensure an even distribution of the samples, while the number of samples and the amount of 500 L of slurry needed is manageable. The storage period of 40 weeks was chosen because the manure storage phase ends in spring in Germany and then the manure application on agricultural land starts. After 20 weeks, two pairs of barrels (with summer samples) were emptied and then used for a fresh liquid manure sample (winter sample, from October for the next 20 weeks until the end of the test), because seasonal differences in the composition of the manure as well as differences in ambient temperature were expected.

It is assumed, that in temperate climates the daily/weekly temperature fluctuation of slurries during full-scale storage is reduced (buffered), due to the high volumes of slurry tanks. Therefore, the barrels were insulated to buffer temperature fluctuations to come close to a full-scale environment. Nevertheless, the temperature varies in practice during the storage period over several months and should therefore not kept constant during the test.

Methane emission potential test at 20 °C

The methane emission potential test at a set temperature of 20 °C enables a comparison between samples of different storage periods from one manure and also between various manure samples. At the beginning of the manure storage test in barrels at ambient temperature and later every 10 weeks samples for the emission potential were put into common batch tests (eudiometer, 400 mL net volume) without inoculum with a set temperature of 20 ± 2 °C over 60 days in triplicates. The procedure is similar to residual gas tests according to VDI 4630 (2016), see also Ch. 8.9 Determination of the residual gas/residual methane potential.

Fig. 5.4-3 visualizes the timetable of sampling for one summer sample over 40 weeks and one winter sample over 20 weeks, including manure storage tests in barrels and the subsequent methane emission potential at 20 °C (eudiometer). Simultaneously to methane emission potential samples, the samples for the biochemical methane potential are taken every ten weeks, but they are stored in a freezer for comparative analyzing with inoculum at the end of the storage test, Fig. 5.4-4. The amount of methane and biogas is needed, if a mass balance is envisaged or carbon dioxide is of relevance in data evaluation.

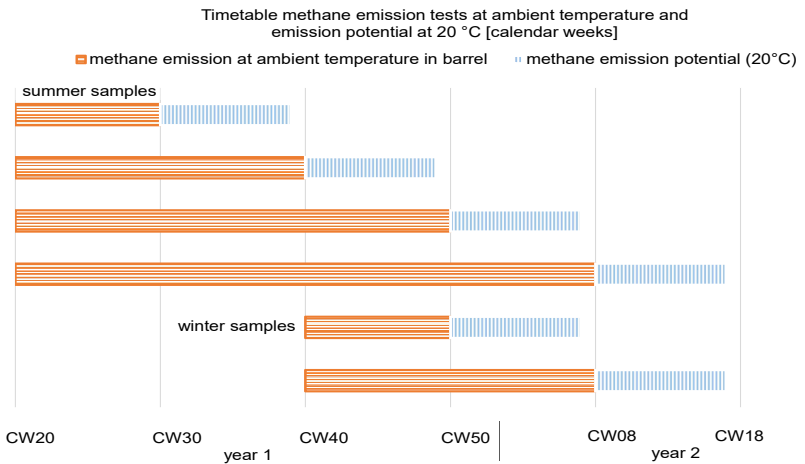

Figure 5.4-3: Timetable sampling of manure storage test at ambient temperature and methane emission potential test at 20 °C (Source: DBFZ)

Biochemical methane potential test (BMP) at 39 °C

In contrast to the emission potentials at ambient temperature or at 20 °C, the biochemical methane potential test at 39 °C shows the energetic potential of the manure under optimal conditions in terms of microbiological consortium from the inoculum, nutrient supply (including trace elements) and constant mesophilic temperature. The alteration of the liquid manure's BMP during the storage period of 40 weeks was in the focus of this methodology. The defined conditions (temperature, inoculum) allow a comparison to other manures or in between samples of one manure.

At the end of the manure storage test (in February of the following year) (Fig. 5.4-4), the BMP-tests with ca. 2-L-samples (kept in a freezer until usage) run simultaneously for all samples in triplicates with a temperature of $39\pm 1\text{ }^{\circ}\text{C}$ using the same inoculum. The BMP-tests were conducted in accordance to VDI GUIDELINE 4630 (2016) (test termination criterion: $< 0.5\%$ new gas formation/3 day), see also Ch. 8.4 Gas yield test (batch) (MARC LINCKE, BJÖRN SCHWARZ, FRAUNHOFER IKTS).

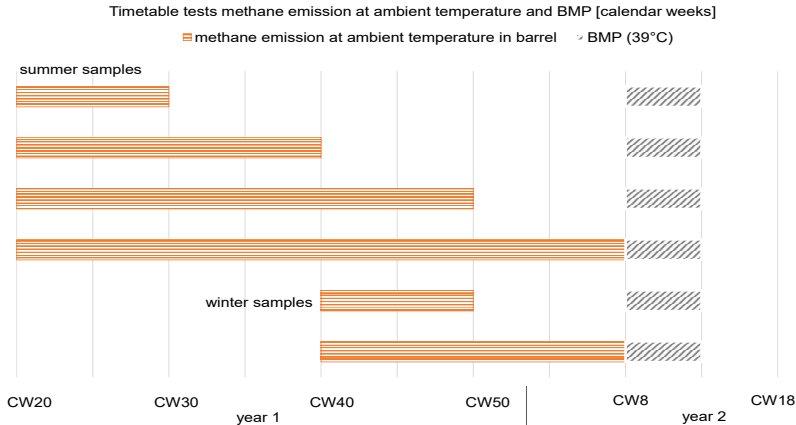

Figure 5.4-4: Timetable sampling of manure storage test at ambient temperature and BMP test at $39\text{ }^{\circ}\text{C}$ (Source: DBFZ)

Data analysis

The methane emission potential of manure during storage at ambient temperature as well as the biochemical methane potential at $39\text{ }^{\circ}\text{C}$ and the methane emission potential at $20\text{ }^{\circ}\text{C}$ at selected times during storage (aging) of liquid manure are detectable by means of this methodology.

The data analysis of

- manure storage test stand (barrel) = methane emission test at ambient temperature,
- methane emission potential test at $20\text{ }^{\circ}\text{C}$ (eudiometer), and
- biochemical methane potential test at $39\text{ }^{\circ}\text{C}$ /energetic loss (AMPTS)

is done in accordance with VDI GUIDELINE 4630 (2016). The gas volumes are standardised (dry gas, 273 K, 1013 hPa). Fig. 5.4-5 shows exemplary the methane emission at ambient temperature of one test with cattle manure, which was measured in the manure storage test stand at DBFZ as sum curve from May to February of the following year. Furthermore, Fig. 5.4-5 visualizes the ambient temperature as weekly averages. Nevertheless, whenever possible the measurements should be conducted at least on a daily bases.

Further analysis are executed according to the Ch. 8.9 Determination of the residual gas/residual methane potential and 9.4 Mass balancing. The methods of more detailed data evaluation (e.g. modelling) are currently under discussion or development and highly dependent on the aim of the investigation.

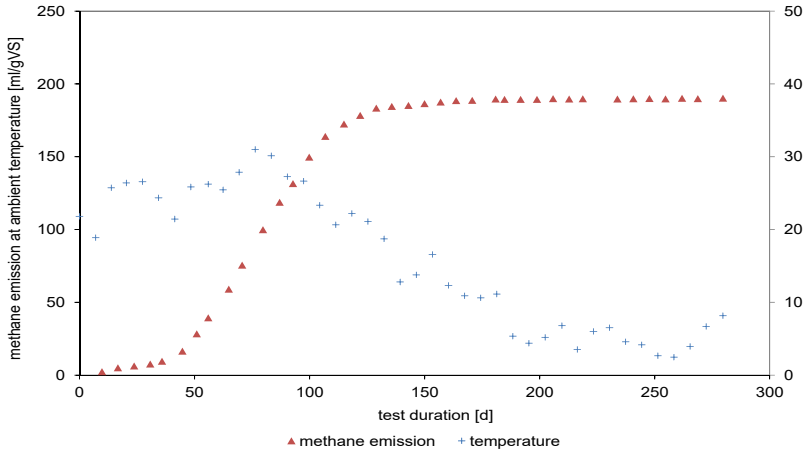

Figure 5.4-5: Methane emission at ambient temperature measured in the storage test stand - Example: sum curve of one test (May - February) with cattle manure on a weekly base (Source: DBFZ)

Outlook

Sampling & seasonality

Taking regard to the more detailed sampling method, described by Stinner (Ch. 3.1), the sampling for the test of storage effects on emissions and yield reduction should follow the following principles. The results of the investigation are strongly dependent on fresh manure. Therefore, it must be possible to take a fresh adequate mixture of faeces, urine and the related litter. This is impossible at stables with manure cellar. In case of dairy cattle, the ideal manure removal system for generating fresh samples, is slider system with manure pit. Fresh and representative samples can be taken from the pit after mixing or from the pipe outlet after the pit. Working safety issues have to be taken under regard (see detailed description of sampling method Ch. 3.1). To generate a fresh representative mixture of faeces and urine, the storage pit needs to be cleared before. It must be taken into regard, that no residues of old manure (e.g. solid crusts, sticking at the walls) get part of the sample. Regular components of the manure, like litter from cattle boxes can be tolerated, but should be described (e.g. kind and amount of litter per animal per day). Irregular components, e.g. fodder residues, cleared once per day or ones every two days, water from milking parlour, should be avoided to become part of the sample. In cases of stables with other manure removal systems, sampling has to take care to generate samples of representative mixture of urine and faeces by complete clearing of manure storage before collection of material to take sample. Collection over short time (below a week) and avoiding of irregular components in the manure.

The planning of the experiments needs to take into regard the seasonal pattern of storage for the specific mass flow and framework conditions. As an example, under moderate climate, manure storages are typically emptied in spring, varying from February to begin of May in the northern hemisphere, depending on cropping system and site conditions (site specific vegetation period of crops, carrying capacity and traffic carrying ability of the soil). Depending on the further cropping fertilizing needs and legal framework conditions for organic fertilizer application, the storage is then filled over the rest of the year or especially during autumn and winter. The planning of the experiment need to implement these specific mass flow storage seasonalities and has to describe it specifically in the method of each measuring.

Manure storage test stand (barrels) - methane emission potential test at ambient temperature

Different framework conditions might cause the necessity of an adaption of seasonal storage time, insulation of the manure storage test stand or temperatures of the subsequent batch-tests, dependent on the kind of slurry, seasonality of mass flows, climate zone and used or planned downstream biogas technology. If differences in temperature between the years are very high, a climatic chamber could be used to simulate the average seasonal and daily fluctuations for specific regions. Beside biogas, hydrolysis gas can also be produced. Hence, hydrogen should be detectable. Low temperatures can cause leaks, while low gas flows can cause inaccuracies in gas quantity measurement.

Methane emission potential test at 20 °C and biochemical methane potential test (BMP) at 39 °C

There is various equipment for the batch test on the market available, which have different options to measure methane or biogas yields. Hence, the tests are not bound to eudiometer and AMPTS. Methane emission potential test at 20 °C should last 150 days or fulfill the test termination criterion $< 0.5\%$ new gas formation/3 day, because 60 days were not sufficient.

Further work is needed to investigate the correlations between various temperatures of manure and its emissions as well as the effects of temperature variance per day and per year, which is dependent on climatic conditions, manure management, cubage, and filling level of the storage tank. Measurements in practice, laboratory tests and modelling together will lead a deeper understanding in the formation of methane emission. This database facilitates the development of strategies to reduce emissions.

5.5 Emission measurements on plants for biological waste treatment

Carsten Cuhls, gewitra - Ingenieurgesellschaft für Wissenstransfer mbH; Torsten Reinelt, Jan Liebetrau, DBFZ

Status	Established sampling configuration and measurement methods. The measurement methods are applied in accordance with the applicable VDI guidelines and DIN/EN standards, c.f. associated standards, and are continuously being developed further both process-dependent and with respect to measuring technology.
Associated standards	VDI 3481 Sheet 3, VDI 3481 Sheet 4, DIN EN 13526, DIN EN 12619, DIN EN ISO 21258, DIN EN ISO 25139, VDI 2469 Sheet 1, VDI 3496 Sheet 1
Application range of the method	Monitoring of specific, channeled and diffuse emission sources.
Limitations of the method	Channeled and diffuse emission source: in accordance with the applicable VDI guidelines and DIN/EN standards, c.f. associated standards, e.g. measurement ranges
Advantages	Measurement method for diffuse emission sources: Higher representativeness of the tunnel measurement method (measurement method with wind tunnel) with respect to the sampling due to the larger encapsulated area of the wind tunnel used. Both convective and diffuse emissions are detected.
Need for research	Due to existing associated standards, no current need for research.

For the emission measurement at biowaste treatment plants, channeled and open emission sources have to be fundamentally differentiated. Waste treatment plants are usually equipped with exhaust air collection systems which channel the exhaust air from the encapsulated areas to an exhaust gas treatment. Afterwards, the cleaned air is released into the atmosphere. The exhaust gas treatment usually consists of a biofilter; at times, an acidic scrubber is installed, as well.

For the analysis of the emissions from the encapsulated emission sources, the exhaust flow of the air collection systems is investigated directly, if possible. The volume flows and the concentrations in the corresponding pipe systems are measured.

Gas sampling systems

Channeled emission sources

The gas sampling from encapsulated process components along with exhaust air collection systems are carried out directly in the respective exhaust air duct.



Figure 5.5-1: Gas sampling from open biofilters (Source: gewitra)



Setup of the wind tunnel above the sampling site



Ambient air supplied to the wind tunnel with two separately installed fans and supply air ducts (front view of the wind tunnel)



Exhaust air from the wind tunnel with the sampling hose (rear view of the wind tunnel)



Exhaust air measuring technology with sampling pump and analysers as well as online acquisition of measured values

Figure 5.5-2: Emission measurements with the tunnel measurement method (wind tunnel) at open composting plants (Source: gewitra)

Open emission sources

Open biofilter

The gas sampling from open biofilters is carried out in the exhaust gas flow after passing through the biofilter material. To catch the exhaust gas flow, a thin film is placed on the biofilter material. Then it is sealed on the sides with sand bags so that the foil bulges due to the exhaust gas flow. The gas sampling line is installed underneath the foil (c.f. Fig. 5.5-1).

Open compost heaps

For the emission measurements at open compost heaps and/or non-encapsulated composting plants, a wind tunnel designed by the gewitra GmbH is being utilised. The simulation of the wind is carried out through a mild air flow generated by means of a fan (c.f. VDI GUIDELINE 3475 Sheet 1 and VDI GUIDELINE 4285 Sheet 1).

The emission measurements are performed with an aerated tunnel on the heap surface of the respective sampling site (compost heap). The tunnel covers a surface area with a width of 6 to 8 m and a length of up to 10 m (c.f. Fig. 5.5-2). Longitudinally and at the entrance area, the tunnel is sealed towards the ground with the use of sand bags. To ensure a free and realistic down gradient of the supplied ambient air, the exit area of the tunnel is not sealed. At the tunnel entrance, two fans are installed that pull in the ambient air from an area with as little preload as possible. At the tunnel exit and/or in the rear internal area of the tunnel, the sampling of the target gases is carried out.

Measured target gases

Carbon compounds

Total carbon (TC)

The concentration of organic substances in the exhaust gas, except for dust-like organic substances, are stated as total carbon (TC). The parameter TC consists of the non-methane volatile organic compounds (NMVOC) and the carbon fraction in methane (CH_4C). As such, by definition, TC combines the volatile organic compounds (VOC). For the measurement of the organic compounds, the flame ionisation detector (FID) is being utilised with hydrogen as fuel gas and propane as a reference.

Volatile Organic Compounds (VOC)

The volatile organic compounds (VOC) include a multitude of substances that all feature a carbon structure. They can have very diverse impacts on the environment. As formers of photochemical oxidants, they lead – together with nitrogen oxides – to the formation of ozone; furthermore, they are also of importance as carriers of intensely smelly substances and as substances hazardous to health.

Non-methane volatile organic compounds (NMVOC)

The non-methane volatile organic compounds (NMVOC) is the total parameter for organic and carbon-containing substances that evaporate easily or are already present as a gas at low temperatures, wherein the gas methane (CH_4) is excluded.

The parameter NMVOC is determined from the difference between TC and the carbon fraction in the methane ($\text{CH}_4\text{-C}$).

NMVOC are mostly formed as metabolites of both aerobic and anaerobic degradation and conversion processes from organic substances contained in the waste material. They may be contained in traces in the waste material in the form of solvents and solvent-containing products.

Due to their volatile characteristics, NMVOCs enter from the waste material into the exhaust gas and/or environment through stripping processes. The gaseous expulsion is intensified by high temperatures and high flows as a result of the stripping effect.

The NMVOC emissions of biological waste treatment consist of the following components which have a total stake of more than 90 % of the NMVOCs: Sulphur compounds (carbon disulphide, dimethyl sulphide, dimethyl disulphide), nitrogen compounds (basic amines), aldehyde (acetic aldehyde, 3-methylbutanal), ketones (acetone, 2-butanone, 2-pentanone), alcohols (ethanol, 2-propanol, 2-butanol, 2-methylpropanol), carbonic acids (formic acid, acetic acid, propionic acid, valerianic acid), esters (methyl acetate, ethyl acetate), terpenes (mycrene, α -pinene, β -pinene, limonene, α -thujone).

Methane (CH_4)

Methane (CH_4) is the largest organic individual component in the sum parameter TC. Methane is odourless and explosible.

The explosion range of methane/air mixtures exists at an oxygen content greater than 11.6 Vol.-% and a methane content in accordance with IEC 6007920 between 4.4 Vol.-% (100 % LEL) and 16.5 Vol.-% (100 % UEL) and/or a methane content in accordance with PTB, EN 50054 between 5.0 Vol.-% (100 % LEL) and 15.0 Vol.-% (100 % UEL).

Methane is a greenhouse gas. The global warming potential value (GWP value) of methane is 28 (c.f. Section "Carbon dioxide equivalent" at the end of this chapter).

Nitrogen compounds

Ammonia (NH_3)

Ammonia (NH_3) is generated by the process of ammonification in the decomposition of organic nitrogen compounds. Ammonia (NH_3) is generated in the decomposition of organic nitrogen compounds such as proteins or urea. It is in a pH value-dependent balance with the ammonium ion (NH_4^+). The emissions of ammonia increase in the case of an

increase of the pH value > 7, in the case of temperatures > 45 °C or in the case of high aeration rates and drop in the case of comparatively high C/N ratios.

Ammonia has the following characteristics:

- Ammonia is volatile so that a part can enter the atmosphere through evaporation, in particular from highly alkaline materials. Ammonia can be noticed by the penetrating salmiac-like odour.
- At an approx. neutral pH value, ammonia exists as ammonium ion (NH_4^+).
- Ammonia dissolves in water while establishing the balance $\text{NH}_3 + \text{H}_2\text{O} \rightleftharpoons \text{NH}_4^+ + \text{OH}^-$ which depends on the pH value and shifts to the right with dropping pH value.
- Ammonia and/or ammonium ions (NH_4^+) are cationic and are, due to their positive charge, severely absorbed to negatively charged clay minerals.

Nitrous oxide (N_2O)

Nitrous oxide is a greenhouse gas that is generated in presence of ammonia in biological waste treatment and. The GWP value of nitrous oxide is 265 (c.f. Section "Carbon dioxide equivalent" at the end of this chapter).

Measurement method

Overview

The measurement methods which are utilised for the emission measurements of the individual substances correspond to the requirements of the respective VDI guidelines and standards in accordance with Tab. 5.5-1

Table 5.5-1: Measurement methods utilised

Substance	Acquisition of measured values	Measurement method	Measuring device, sampling	Guideline, standard
Total carbon	Continuous, online data	FID method	Bernath Atomic 3006	VDI 3481 Sheet 3, VDI 3481 Sheet 4, EN 13526, EN 12619
Methane, nitrous oxide	Continuous, online data	IR method	ABB Advance Optima URAS 14	VDI 2469 Sheet 2
Methane, nitrous oxide	Discontinuous, laboratory analysis	GC method with autosampler	Sampling with evacuated vials	VDI 2469 Sheet 1
Ammonia	Discontinuous, laboratory analysis	Wet-chemical method with sulphuric acid	Sampling with Desaga pump and 2 gas-washing bottles	VDI 3496 Sheet 1

Continuous measurements

Total carbon

The sampling for the continuous determination of TC is carried out by a heated line that leads to an FID.

The analysis values are continuously being recorded during sampling (A/D converter LABCOM 16 and MemoComp software, Breitfuss company).

Methane, nitrous oxide

The sampling for the continuous determination of methane (CH_4) and nitrous oxide (N_2O) is carried out by a sampling line that leads to the gas analyser with online data acquisition. The gas sample passes through a condensate trap and is continuously measured by means of ND infrared spectroscopy (gas pump and gas analyser Advance Optima URAS 14, ABB company). The analysed values are continuously being recorded during sampling (A/D converter LABCOM 16 and MemoComp software, Breitfuss company).

Discontinuous measurements

Methane, nitrous oxide

For the discontinuous determination of methane (CH_4) and nitrous oxide (N_2O), gas samples are directly taken by evacuated headspace vials (20 mL) from the sampling line by means of a double cannula through a butyl septum. Prior to sampling, the headspace vials are evacuated to a residual pressure of 6 mbar with a rotary valve vacuum pump (Vacuubrand, type RE 2). The residual pressure is checked by a digital vacuum meter (Greisinger Electronic, GDH 12 AN).

For the analysis of N_2O and CH_4 , a gas chromatograph (SRI 8610 C) is utilised. N_2O is measured by an electron capture detector (ECD), while CH_4 is measured by an FID. The quantification of the sample is carried out with external standards. For the emission measurements, mixed standards with rated concentrations of 0.27 ppmv, 1.5 ppmv and 2.7 ppmv N_2O and/or 1.7 ppmv, 7.5 ppmv and 16.5 ppmv CH_4 (Air Products speciality gases) are utilised. For the calculations of the N_2O concentrations, a linear progression of the calibration function is assumed up to 4 ppmv, while the signal for concentrations > 4 is following a polynomial of the 2nd degree. The signal progression of the FID for CH_4 is linear in the relevant range of concentration. Standards are measured after 20 samples each in order to perform an adjustment of the calibration over the course of time.

Ammonia

The sampling for the determination of ammonia (NH_3) is carried out by a sample line that is passed – without gas refrigeration – through two gas washing bottles filled with sulphuric acid (pump by Desaga company). The sampling of the target gas takes an average of 30 min and is carried out by absorption in sulphuric acid in accordance with VDI GUIDELINE 3496 Sheet 1. Subsequently, the concentration of ammonia nitrogen is determined in the laboratory wet-chemically from the taken sample. The result is a half hour average.

Measurement of the volume flows

The volume that flows within the pipes are detected by a vane anemometer or Pitot tube sensors. For this, 10 individual measurements are carried out from which the arithmetic mean is calculated. The used vane anemometer is of type 1416, with a measurement range of 0.7–20 m s⁻¹; the used Pitot tube with manometer is an AIRFLOW Pitot tube with digital manometer model DM30 with the measurement range at -3,000–3,000 Pa. During the emission measurement, the constance of the volume flows is ensured so that a continuous measurement can be omitted.

Evaluation of the measured values

Mass concentrations

In accordance with the Technical Instructions on Air Quality Control, Section 2.5 a) (TA Luft), the mass concentration refers to the mass of emitted substances relative to the volume of exhaust gas at standard temperature and pressure (273.15 K; 101.3 kPa) after the deduction of the water content of water vapour.

The mass concentrations of the substances TC, methane and nitrous oxide are continuously being recorded online with a scanning interval of 1 s and are being logged as average per minute and/or per 30 s. Simultaneously, exhaust gas samples for the determination of CH₄ and N₂O are taken discontinuously from parallel points of measurement. The parameter NMVOC refers to the concentration of total carbon in the measured gas less the carbon concentration of methane in accordance with VDI 3481 Sheet 4.

During the measurement period, the mass concentration of ammonia is taken discontinuously. The sampling of the exhaust gas flow is carried out over a duration of 30 min through absorption in sulphuric acid in accordance with VDI GUIDELINE 3496 Sheet 1 and is subsequently analysed in the laboratory.

The mass concentrations of the measured substances are stated in the unit mg per m³ of dry air at standard temperature and pressure (mg m⁻³ STP) as half hour averages (HHAVs) and as daily averages (ADs).

Mass flows

The mass flow (emissions mass flow), in accordance with the Technical Instructions on Air Quality Control, Section 2.5 b) (TA Luft), refers to the mass of the emitted substances relative to time. The mass flow states the emissions occurring during an hour of operation of the plant as intended under the typically practised operating conditions.

The mass flows are calculated by means of volume flows and occurring concentrations in the corresponding pipe systems.

The mass flows of the measured substances are determined by multiplying the mass concentration with the exhaust gas volume flow of dry air at standard temperature and pressure in the unit m³ (STP) per h. The mass flows are specified in the unit g per h.

Emission factors

The emission factor, in accordance with the Technical Instructions on Air Quality Control, Section 2.5 d) (TA Luft), refers to the ratio of the mass of the emitted substances to the mass of the processed substances. The emissions of the whole plant that occur during operation as intended under the typically practised operating conditions (regular operation) are included in the mass ratio.

The emission factors of the measured substances are determined by dividing the sum of the mass flow over the measurement duration in the unit g by the wastes fed during the measurement period into the biological treatment stage in the unit Mg. The mass ratios, and thereby the emission factors, are specified in the unit g per Mg of wet mass.

Carbon dioxide equivalent

The carbon dioxide equivalent (CO₂-eq.) represents a unit of measure for the comparison of emissions of different greenhouse gases, but does not imply the same reaction with respect to a climate change. The equivalent CO₂ emissions are determined by multiplying the emissions of a greenhouse gas for a specified period of time with its GWP. For a mixture of greenhouse gases, the GWP is determined by adding up the equivalent CO₂ emissions for each individual gas. The following also applies to the analyses of the project at hand: The objective of composting of biowastes and green wastes is the decomposition of organic substances and the creation of stable humus forms. The carbon dioxide released as microbial metabolite during the biological stabilisation processes does not originate from a fossil source, but rather from a renewable resource and therefore does not enter the balance as a climate-relevant greenhouse gas, but rather acts as a climate-neutral.

In accordance with the Fifth Assessment Report (AR5), the following GWP values are assumed for a period of 100 years (c.f. Tab. 5.5-2) for the calculation of the carbon dioxide equivalent: **CH₄ = 28; N₂O = 265** (IPCC 2013). The CO₂-eq., determined from the emissions factors of methane and nitrous oxide, is specified in the unit kg per Mg wet mass.

Table 5.5-2: Comparison of the GWP values for a period of 100 years in accordance with the Fifth Assessment Report (AR5), Fourth Assessment Report (AR4), Third Assessment Report (TAR) and Second Assessment Report (SAR) of the Intergovernmental Panel on Climate Change (IPCC)

Report	Reference	Methane	Nitrous oxide
Fifth Assessment Report (AR5)	[IPCC 2013]	28	265
Fourth Assessment Report (AR4)	[IPCC 2007]	25	298
Third Assessment Report (TAR)	[IPCC 2001]	23	296
Second Assessment Report (SAR)	[IPCC 1996]	21	310

5.6 Determination of the total emissions from biogas plants by means of optical remote sensing

Tanja Westerkamp (former DBFZ)

Status	Established measurement method for the detection of emissions from animal husbandry and landfills. The measurement method is applied in accordance with the applicable VDI guideline, c.f. associated standards, and is continuously being developed further both with respect to measuring technology and in terms of the simulation.
Associated standard	VDI 4285
Area of application of the method	Quantitative determination of diffuse and spatially spreaded emission sources
Limitations of the method	No localisation of individual source, lower limit of detection of the measuring devices, dependency on meteorological conditions.
Advantages	Measurement method detects the concentrations of methane and ammonia in the down wind of the source area and allows for the determination of the emission rate of the whole site.
Need for research	Need for research with respect to the limits of the micro-meteorological simulation model.

In addition to stationary emission sources such as the exhaust air from CHPs or gas processing, biogas plants also feature diffuse sources. Those include leakages and diffusion of gas as well as emissions from open storage of substrates and digestate. In order to measure the total emissions of a biogas plant, optical remote sensing represents a suitable method. With the help of a tunable diode laser absorption spectrometer (TDLAS), the concentrations of methane and ammonia in the down wind of the plant can be detected over several hundred meter long measurement paths in the ground level atmosphere. At the same time, the weather conditions are recorded, wherein the measurement of the wind by means of 3D sonic anemometer is of decisive importance. The measurement values are entered into the simulation software "Windtrax" for the determination of the emission rates of the plants via inverse dispersion.

Measurement technique

For the measurement of gas concentrations in the atmosphere over long distances, in principle, several measurement methods are suitable. Introduced here is a TDLAS system in combination with a weather station that is equipped with a 3D sonic anemometer. The devices are depicted in Fig. 5.6-1.



Figure 5.6-1a: Weather station (Source: DBFZ)



Figure 5.6-1b: To the left: reflector modules, to the right: laser spectrometer (Source: DBFZ)

TDLAS

Depending on structure and complexity, molecules feature a certain number of vibrational modes. The vibrations are excited through absorption of light in the middle infra-red range. In addition, harmonic overtones occur in the near infra-red range. Organic molecules in particular feature characteristic absorption spectra in this spectral range. With the help of semiconductor laser diodes it is possible to measure individual absorption lines of certain molecules over a range of a few nanometres in order to determine the concentration of the target substance in the optical path of the laser. In accordance with the Beer-Lambert law, the intensity of the laser beam decreases exponentially dependent on the wave number which is the reciprocal wavelength of the laser light, as follows:

$$I(\tilde{\nu}, L) = I_0(\tilde{\nu}) \exp(-\sigma(\tilde{\nu}) NL) = I_0(\tilde{\nu}) \exp(-S \phi(\tilde{\nu} - \tilde{\nu}_0) NL)$$

19

I	Transmitted intensity
I_0	Intensity of output
$\tilde{\nu}$	Wave number
σ	Absorption cross-section
N	Particle density
L	Optical path length
S	Line thickness
ϕ	Lineshape function
$\tilde{\nu}_0$	Wave number of the line centre.

In addition to the thickness and shape of the absorption line, the length of the absorption path, meaning the distance between the laser and the detector, and the density of the gas analysed also have an influence on the strength of the absorption. As such, it depends directly on the number of molecules in the beam's paths. In the case of a uniform spatial distribution of the gas to be detected, the resolution therefore improves with the length of the absorption path. Consequently, the measuring path should be as long as possible, but should not extend too far outside of the area of the emitted plume in order to obtain an optimal resolution. These facts are schematically depicted in Fig. 5.6-2.

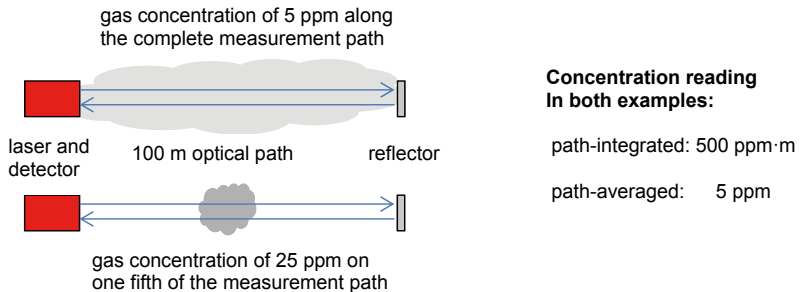

Figure 5.6-2: Schematic depiction of path-integrated and path-averaged concentration information
(Source: DBFZ)

The resolution of the Open Path TDLAS devices of the manufacturer Boreal Laser Inc. for methane and ammonia is specified with $1 \text{ ppm} \cdot \text{m}$. In the case of an optical path length of 10 m, the resolution therefore would be 0.1 ppm, in the case of a 1,000 m measuring path, it would be 0.001 ppm. However, with increasing path length, the influence of atmospheric interferences increases. The limit of detection for a path of 200 m length is specified with 0.03 ppm.

The system is designed such that the laser and a photo diode used as detector are located in a shared housing. Central element is the laser diode suitable for the respective target gas. Its laser beam hits a beam separator. The one partial beam exits the housing, crosses through the air to be measured, is reflected by a reflector module at a distance of up to 500 m, and is detected by the photo diode upon re-entry into the housing. The other part of the beam is passed through an internal reference cell. Another photo diode detects this beam that crossed through the reference cell. Subsequently, the measuring signal and the reference signal are compared in order to determine the gas concentration on the measuring path. This way, a continuous calibration is performed. With the help of a software-controlled pan and tilt unit, the lasers can automatically point several reflector units in sequence. A required equipment for the analysis of the measurements is a laser distance meter for distances of up to 500 m.

Weather station

For the determination of emission rates based on measured concentrations, the measurement of the wind conditions near the ground is indispensable. In the case of utilisation of the simulation software Windtrax, the use of a 3D sonic anemometer is a well suited option for this purpose. Furthermore, the ambient temperature and pressure at the measurement site must be recorded.

Measuring set-up

For the estimation of the total emissions at the biomethane plant, long measuring paths are set up in the down wind plume of the plant at a height of approx. one to two meters. Depending on the size of the plant, the distance from the plant, and the wind speed, distances between spectrometer and reflector of approx. 100 m to up to 500 m can be utilised. It must be taken into consideration that the measurements are carried out in sufficient distance from the plant in order to avoid turbulence interference at the place of the concentration measurements. However, the distance should not be selected too large, since the concentration of the gases to be measured decreases with increasing distance. It might be that an interference-free measurement is not possible for all plants and any wind direction since additional constructions or trees may interfere. Furthermore, it must always be clarified to what extent the option exists to be able to set up the measurement devices on neighbouring fields. In the summer months, arable crops that grow tall (e.g. maize) may be potentially an obstruction. Also important are measurements of the background concentrations. Methane, in particular, occurs naturally in the atmosphere. Since the concentration features a diurnal variation, it is recommended that the background should be measured simultaneously or at least at different times of the day.

Inverse dispersion modelling

Methods of forward and inverse dispersion calculations that are based on Lagrange stochastic models (VDI 3945 BLATT 3 2000; SCHÜRMANN 2007; VESALA et al. 2008; WILSON & SAWFORD 1996) have been evaluated for numerous areas and found application in there. In such models, particles are considered on their path along trajectories, i.e. the flight paths from the perspective of the particles. The simulation of a multitude of such trajectories allows for the numeric determination of emission flows if influencing meteorological parameters are taken into account. A differentiation must be made between two approaches: The forward model and the backward model.

Forward-calculating Lagrange models determine the dispersion of a substance from a defined point source or area source. This method is, for instance, required by the "Technical Instructions on Air Quality Control" (TA LUFT 2002). An exemplary implementation is with the software AUSTAL2000 (ING.-BÜRO JANICKE ENGINEERS' OFFICE 2011). However, if one wants to derive the source strengths of diffuse sources from measured concentrations with the help of a forward model, this approach is very CPU-intensive since a multitude of simulated particles will not pass the position of the concentration measurement (SCHMID 2002). In order to receive statistically meaningful results, therefore a very large amount of trajectories must be determined, in particular in the case of area sources.

FLESCH et al. (1995) therefore developed a method to calculate backwards in time, starting at the points of measured concentrations. The model simulates the flight paths of thousands of air parcels backwards, starting from the site of the concentration measurement, and determines for each parcel at which location it last touched the ground. In this way, a catalogue of the distribution of the touchdown results. When the location and the dimensions of the emission source are given the fraction covered by touchdowns is calculated. By now, this method is established as backward-Lagrangian Stochastic (bLS) model and is implemented in the freeware Windtrax (THUNDER BEACH SCIENTIFIC 2011). A big advantage of this method is based on the simple test setup. The concentration measurements in the down wind plume can be carried out at a height of one to two meters above the ground (HARPER et al. 2011).

In addition to the measured concentrations as well as location, size and shape of the source area, the following meteorological input data are required for the calculations in Windtrax: Temperature, ambient pressure, wind direction and wind speed in three dimensions. When using a 3D sonic anemometer, all required micro-meteorological parameters for the simulation such as the roughness length z_0 , the Obukhov length L , and the friction rate u^* as well as the standard deviations of the wind speeds are calculated from these data. The roughness length refers to the height at which the wind speed disappears in the ground level atmosphere due to the logarithmic wind profile. It is dependent on the characteristics and plant cover height of the ground. It can be determined from the structure of turbulent fields in proximity to the ground (FOKEN 2003). The Obukhov length is a measure of the stability of the atmosphere. It specifies the relationship between the dynamic, thermal, and buoyant lift processes. In the case of a stable stratification, i.e. for instance during clear, calm nights, L is positive. In the case of an unstable stratification, for instance on sunny afternoons, L is negative. In the case of a neutral stratification, as it occurs in the case of a cloudy sky and/or strong wind, $|1 L^{-1}|$ approaches 0. The friction rate is linked with the wind speed and is a measure for the vertical transport of a horizontal movement near the ground.

Numerous experiments were able to show that Windtrax is well suited for the determination of diffuse emissions, taking into consideration certain restrictions. For one, this method was tested in different gas release experiments, c.f., for example, (CRENNA et al. 2008; FLESCH et al. 2005a; GAO et al. 2010; MCGINN et al. 2006). The amounts of gas calculated were subsequently compared to the amount of gas actually released. An overview of the results from 12 such studies provided a mean value of 98% for the relationship of the calculated emissions to those released. The mean value of the standard deviations is 21% (HARPER et al. 2010). For another, with this method, the emissions of herds of cattle (LAUBACH & KELLIHER 2005; LAUBACH 2010) and cattle sheds (FLESCH et al. 2005b), pig farms with bioethanol production (HARPER et al. 2010) as well as of a biogas plant (FLESCH et al. 2011) were determined and in part compared to other methods.

For using inverse dispersion modelling by means of Windtrax for the determination of the emissions rates of biogas plants, the following restrictions result (FLESCH et al. 2004):

- The mathematical model Windtrax is based on the Monin-Obukhov similarity theory. From this, the restrictions with respect to the applicability of the model do result. Experience has shown that measurements are only usable if $u^+ \geq 0.15 \text{ m s}^{-1}$ and $|L| \geq 10 \text{ m}$.
- An idealisation of three-dimensional structure as ground level area sources requires a distance of the concentration measurements from the source of approx. ten times the height of the obstacles. This distance also must be adhered to due to the disturbance of the wind field by the structures.
- The distance between the source and the measurement should be small enough that the concentrations can be measured accurately enough, taking the background into consideration.
- The positioning of the measuring installation should be carried out such that the effective area of influence of the trajectories covers at least 50% of the source area. This point must in particular be adhered to in the case of changes of the wind direction during the measurements.
- It is recommended that the measurements (concentration and meteorological data) are averaged over 10 to 30 min.

Measurement results

The measured concentration values are specified as path-integrated concentration in the unit ppm*m. In the case of a background concentration of 2 ppm in the air and a path length of 500 m, this results in a path-integrated concentration of 1,000 ppm*m. Assuming good visibility, the measuring accuracy in this example is at a few ppm*m. The measuring of the length has an accuracy of one meter. Deviations from the natural background of more than 10 ppm*m are usually detectable well. For the above example, this means that an average concentration increase of 20 ppb can be detected on the measuring path.

The background of ammonia in the atmosphere near the ground is very low but depends on the ground's plant cover. The values are at the limit of detection of the measuring device. In order to be able to prove a concentration increase due to the biogas plant, a measured value that is increased by at least 20 ppm*m should be present.

The increase of the measured value through emissions from the system is directly connected to the distance of the measuring path from the plant and to the wind speed. Without a micro-meteorological dispersion model, a direct statement regarding the emissions rate based on the measured concentration is not possible. Windtrax features a graphical user interface in which a schematic of the measuring setup is drawn. Measured concentrations and weather data can be provided via an input file. Recommended are mean values of 10 to 30 min. Depending on the CPU power, the number of simulated particles, and the number of measuring series, the simulation may run from a few minutes to several hours. The results can be written to an output file. As result, an emission rate of the plant is received, for example, in kg h^{-1} as well as the corresponding standard deviation. In addition, micro-meteorological indicators are an additional metric for the quality of the simulation. The emission factors for a respective plant can be derived via the determined emission rate, the density of the measured gas at standard conditions and the production rate of the plant.

5.7 Monitoring of operational methane emissions from pressure relief valves of biogas plants

Torsten Reinelt, Jan Liebetrau, DBFZ

Status	The method is recently developed and established for emission monitoring of biogas plants. (REINELT et al. 2016) presented the development of the method. To date, the method is not part of an official standard. The method was used for long-term monitoring (up to two years) of pressure relief valves (PRV) on agriculture biogas plants within German research projects.
Standard	The method is included in the guideline "Recommendations for reliable methane emission rate quantification at biogas plants" (CLAUSS et al. 2019).
Area of application of the method	The method was custom-built for the qualitative and quantitative determination of operational and time-variant methane emissions from PRVs of biogas plants. Depending on the design of the PRV, a transmission of the method to other gas-producing facilities (e.g. in the natural gas sector) is possible.
Disadvantages	The refitting of a PRV is usually challenging to realise due to two main reasons: <ol style="list-style-type: none"> 1. The measurement equipment has to pass the requirements of at least gas explosion protection category II causing usually higher costs for the sensors. 2. Since a PRV is an important safety device, its functionality (e.g. the pressure limit) must not be changed by the refitting with explosion proof sensors. Consequently, a measurement setup has to be checked by a technical expert in accordance to the relevant national standards (e.g. the Industrial Safety Regulation in Germany).
Advantages	The method allows the long-time monitoring of PRVs and consequently the determination of representative methane emission factors for this specific source. The method also enables the identification and implementation of specific emission mitigation measures focusing on the biogas storage management and the mode of operation of the biogas plant.
Need for research	There is a need for research with respect to the reduction of measurement uncertainties and for the development of a method to estimate the emission potential of PRVs by using only operational data.

The compensation of imbalances between gas production and combustion of biogas in the gas utilization requires the intermediate storage of the produced biogas. The biogas is mostly stored in low-pressure membrane gasholders which are often integrated in the membrane domes of the digesters. Furthermore, external gasholders are common.

However, each gasholder has to be equipped with at least one PRV avoiding unacceptable pressure conditions which possibly cause damages on the membrane gasholders. But each release event of a PRV simultaneously causes the emission of raw biogas into the atmosphere, which should be avoided as far as possible due to ecological, economical and safety reasons. Since the emission behaviour of a PRV is very time-variant and depends on many influencing factors (e.g. seasonal factors like the ambient temperature), a permanent emission monitoring is recommended. A couple of possible and in field operation tested measurement methods are described in the following section.

Measurement methods

In (REINELT et al. 2016) and (REINELT 2017b) two possible measurement methods for the long-term monitoring of PRVs are presented. The methods are based on the measurement of the flow velocity and/or the temperature in the exhaust pipe of a PRV. Both methods have to be distinguished based on the measurement principle. The flow velocity method quantifies directly the released methane emission rates from the investigated PRV. The temperature method only registers the number and duration of PRV release events. For emission rate estimations, assumptions for flows within the pipe have to be used.

Flow velocity method

The monitoring of the flow velocity in the exhaust pipe of a PRV delivers an exact measurement of the released methane emission rates. A detailed description of the method is given in (REINELT et al. 2016). When the PRV emits, the sensor registers the flow velocity of the gas within the exhaust pipe, which can be related to the cross-sectional area of the pipe. In consideration of the discontinuously measured methane content in the corresponding gasholder, the released methane volume flow can be calculated according to Eq. 20.

$$\dot{V}_{\text{CH}_4} = \frac{c_{\text{CH}_4}}{100} \cdot \bar{v} \cdot \frac{\pi}{4} \cdot d_i^2 \cdot t \quad 20$$

\dot{V}_{CH_4}	Released methane volume flow under process conditions	$\text{m}^3 \text{h}^{-1}$
c_{CH_4}	Methane content in the gasholder	%
\bar{v}	Mean flow velocity	m s^{-1}
d_i	Inner diameter of the PRV exhaust pipe	m
t	Time constant for conversion of $\text{m}^3 \text{s}^{-1}$ in $\text{m}^3 \text{h}^{-1}$	3,600 s h^{-1}

Then the methane volume flow is numerically integrated for each release event. For the conversion of the methane volume in dry condition of a single release event, a saturation of vapour of the released biogas volume can be assumed. Afterwards, the saturation vapour pressure is determined by the Magnus formulae (SONNTAG 1990) according to Eq. 21.

$$E_w(\vartheta) = 6.112 \text{ hPa} \cdot \exp\left(\frac{17.62 \cdot \vartheta_{\text{biogas}}}{243.12 \text{ }^\circ\text{C} + \vartheta_{\text{biogas}}}\right) \quad 21$$

$E_w(\vartheta)$	Released biogas volume flow under process conditions	hPa
$\vartheta_{\text{biogas}}$	Biogas temperature measured in the exhaust pipe of the PRV during a release event	$^\circ\text{C}$

Finally, the methane volume is converted to normal conditions by Eq. 22.

$$V_{\text{CH}_4} = V_{\text{CH}_4(\text{real})} \cdot \frac{(p_{\text{air}} - E_w(\vartheta)) \cdot 273.15 \text{ K}}{1013.25 \text{ hPa} \cdot (273.15 \text{ K} + \vartheta_{\text{biogas}})} \quad 22$$

V_{CH_4}	Released methane volume in normal conditions and dry (standardised)	$\text{m}^3 \text{ STP}$
$V_{\text{CH}_4(\text{real})}$	Released methane volume in process conditions	m^3
p_{air}	Atmospheric pressure measured on-site the biogas plant	hPa

Besides the quantification of the released methane volume, the flow velocity method is also able to determine the frequency and duration of the single PRV release events. Possible flow velocity sensors are vane anemometers or vortex sensors. The use of vortex sensors should be usually preferred compared to vane anemometers. A vortex sensor has a higher durability because it has less moving parts compared to a vane anemometer.

Fig. 5.7-1 shows the intraday release events from an investigated PRV that is monitored by the flow velocity and temperature sensors. Both methods agree with regard to their signal behaviour during the release events.

Temperature method

The temperature method uses the temperature difference between the stored biogas in the gasholder and the ambient temperature. When the PRV starts to emit, the released biogas causes a positive rising temperature flank. As long as the PRV actively emits, the temperature remains on an elevated level compared to the ambient temperature. After the end of a release event, the cooling of the temperature to the ambient level causes a decreasing temperature flank (Fig. 5.7-1). The height of the temperature flanks and thus the signal strength essentially depends on the seasonal temperature conditions and the material of the exhaust pipe. For the determination of a single release event, the positive and negative slopes of the temperature flanks (first derivative) have to be used. Before the first derivative is calculated, the temperature data have to be smoothed by a mathematical filter (sliding average). For a grey plastic exhaust pipe, a positive limit slope of $+1 \text{ K min}^{-1}$ (corresponds to $+0.0167 \text{ K s}^{-1}$, green line in Fig. 5.7-2) and a negative limit slope of -0.5 K min^{-1} (corresponds to -0.0083 K s^{-1} , orange line in Fig. 5.7-2) can be recommended.

In contrast to the flow velocity method, the temperature method does not allow a direct quantification of the released methane volume. Only a qualitative monitoring including the number and the duration of release events is possible.

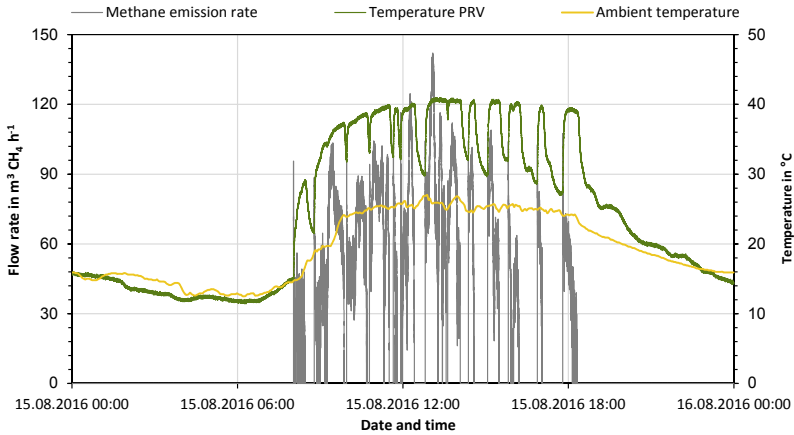

Figure 5.7-1: Triggering of a PRV in the course of the day; In the exhaust pipe of the PRV, a flow velocity sensor (black line) and a temperature sensor (red line) were installed. Both signals correspond to each other. Modified from (REINELT 2017a)

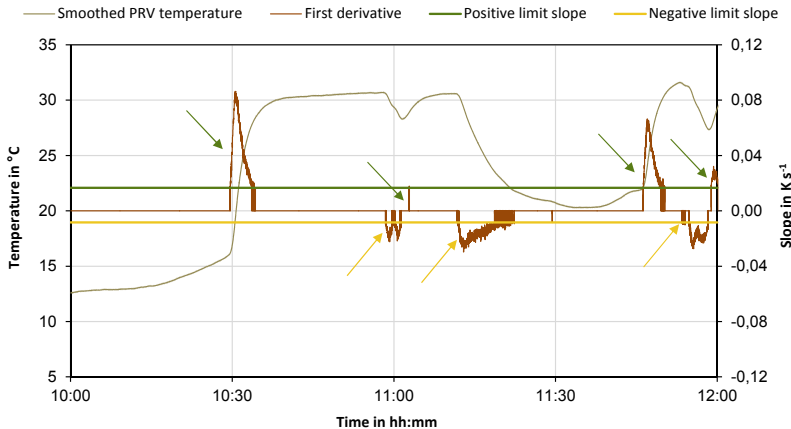

Figure 5.7-2: Calculation of the duration of a triggering event based on temperature data.

Measurement setup

Independent from the used method, the chosen sensors have to be installed in the exhaust pipe of the investigated PRV. An exemplary measurement setup is shown in Fig. 5.7-3 carried out at the PRVs of a German biogas plant with one main digester and one gastight covered digestate storage.

The following explanations are related to the measurement setup shown in Fig. 5.7-3.



Figure 5.7-3: Exemplary measurement setup at the PRVs of an agricultural biogas plant; Left: Flow velocity and temperature sensor installed at the PRV of the main digester (cp. Fig. 5.7-1); Centre: Temperature sensors installed at PRVs of the gastight covered digestate storage; Right: Data logger; Figure modified from (LIEBETRAU et al. 2017)

PRV of the main digester – quantification of the released methane emission rates

An explosion-proof flow velocity vortex sensor (type: VA 40 m s⁻¹ p3 ZG8 Ex-d, co. Höntzsch GmbH, Waiblingen, Germany) was installed in the exhaust pipe (length 1 m, inner diameter 0.152 m) of the PRV. The sensor was positioned at a height of 0.75 m to ensure the best possible ratio between inlet and outlet zone. With the chosen configuration, the inlet zone is five times the hydraulic diameter and the outlet zone is 1.67 times the hydraulic diameter of the PRV exhaust pipe. As verification of the flow velocity signal (cp. Fig. 5.7-1), an additional temperature sensor was installed at a height of 0.3 m (Type: TWL-113AGBG4AA0, co. KOBOLD Messring GmbH, Hofheim, Germany). Both sensors were connected to a data logger (Type: MSR 160B7, Co. MSR Electronics GmbH, Seuzach, Switzerland) with integrated power supply in a cast aluminium box. The methane content in the stored biogas was randomly analysed four times by a portable biogas monitor (Type: BM 2000, co. Geotechnical Instruments Ltd., Leamington Spa, UK). The methane content was averaged (51.8 ± 1.6%) and assumed to be constant during the PRV release events.

PRV of the gastight covered digestate storage – determination of the frequency of release events

Due to safety reasons caused by the high biogas storage capacity of the gasholder, the digestate storage had two PRVs. Both valves were refitted with one temperature sensor in a height of 0.75 m (Type: TWL-113AGBG4AA0, Co. KOBOLD Messring GmbH, Hofheim, Germany) each. Both sensors were connected to a data logger (type: LogTrans 16, Co. Umwelt- und Ingenieurtechnik GmbH, Dresden, Germany) with integrated power supply in a cast aluminium box.

General comments to the chosen measurement setup

The measurement setup as shown in Fig. 5.7.-3 was part of a long-term monitoring of the PRVs of an agricultural biogas plant within the research project "BetEmBGA". Main purpose was the quantification of operational methane emissions that are released by PRVs for the first time. However, flow velocity sensors are usually much more expensive than temperature sensors. Therefore, only the PRV of the main digester was refitted with a flow velocity sensor because it was assumed that the share of this PRV on the overall methane emission is higher compared to that of the digestate storage. To detect whether the digestate storage had release events at all, the PRVs of this gasholder were refitted with additional temperature sensors.

However, depending on the on-site conditions of other biogas plants and the purpose of the investigation, the measurement setup might be changed. Following aspects have to be considered:

Flow velocity method:

- This method is first choice if the precise quantification of the released methane emission rates is the main purpose of the investigation.
- The dimension of the PRV exhaust pipe (cross-sectional area, length) influences the type of the preferred flow velocity sensor. For pipes with an inner diameter $d_i \leq 0.15$ m a vortex sensor is recommended because of its durability. However, if $d_i \geq 0.15$ m, a vane anemometer with a big impeller is recommended, since it has a lower detection limit.
- The position of the flow velocity sensor in the PRV exhaust pipe should be chosen as compromise between the necessary inlet/outlet zones (accuracy) as well as the necessary wind protection (possible spurious signal).

Temperature method:

- This method can be used if only a qualitative determination of the frequency of PRV release events is the main purpose of the investigation or an estimation of emission rates is sufficient.
- The material of the PRV exhaust pipe (e.g. plastic or stainless steel) influences the signal strength of the method due to a different self-heating depending on the material of the PRV exhaust pipe.

Safety issues

A PRV is a very important safety unit serving as the very last possibility for the compensation of unacceptable pressure conditions of the gasholders. Consequently, the operational capability of the PRV has to be ensured anytime. Therefore, the refitting with monitoring sensors must not change the methane release behaviour of the PRV. In particular, the pressure drop has to be considered, which can be caused by an installed sensor or by an extended exhaust pipe. Thus, the limit pressure of the PRV can increase. Additionally, PRVs are usually rated as a gas (not dust!) explosion zone (e.g. in Germany: 1 m zone 1 around the opening of the exhaust pipe and 3 m zone 2 around the opening of the exhaust pipe).

Consequently, the used measurement equipment has to be explosion proof (category II or I) and accredited for at least gas explosion zone 1 or zone 0. For legal security of the biogas plant operator and the measurement institution, the measurement setup has to be checked by a technical expert according to the legal regulations in the respective country.

Uncertainties

Both methods have uncertainties, which should be considered by the user. They are listed below:

Flow velocity method:

- If a vane anemometer is used, the stopping time of the impeller has to be considered that could lead to an overestimation of the measured methane emission volume (REINELT et al. 2016).
- In case the PRV is connected to a service access with a submerged agitator, the vibrations during mixing intervals could cause spurious signals.
- So far, the methane content of the gasholder is analysed discontinuously and assumed to be constant during methane release events. An optimisation is an additional sampling probe at the PRV with a continuous gas sampling for the biogas analysis. However, the effort for this gain of accuracy is disproportional high.
- For a general exclusion of spurious signals of the flow velocity sensor, an additional temperature sensor always should be installed in the same PRV.

Temperature method

- The temperature sensor and the resulting temperature flanks have to be calibrated depending on the construction material (stainless steel or plastic) and the colour of the exhaust pipe because both affects the self-heating of the exhaust pipe (e.g. by sunshine) and hence the signal strength of the temperature flanks. For grey coloured plastic pipes, slopes of $+1 \text{ K min}^{-1}$ (positive flank) and -0.5 K min^{-1} (negative flank) can be recommended for temperature sensors with dip tubes.
- The duration of release events determined by the temperature method is overestimated (about 48%) compared to the flow velocity method due to the evaluation with slopes of the temperature flanks.

5.8 Measurement of volatile organic trace compounds

Jorge Iván Salazar Gómez, Andrea Gerstner, Alisa Jovic, Fraunhofer UMSICHT

Status	The method was tested and good results were achieved, but a validation of the method presented still has to take place.
Associated standards	The sampling and the subsequent measurement of the VOCs is carried out based on DIN EN ISO 16017 1 ("Sampling and analysis of volatile organic compounds by sorbent tube/thermal desorption/capillary gas chromatography - Part 1").
Substrates/materials	Application in the case of volatile organic trace compounds in gaseous state (biogas sampling generally at room temperature).
Limitations of the method	An exact measuring range has not yet been determined (validation required), potential overloading of the thermal desorption tubes (connection in series required), time-consuming conditioning of the 2-bed and 3-bed thermal desorption tubes before and after sampling, too high water vapour content may interfere with the adsorption process (condensate trap required).
Advantages	Longer storability of samples (if refrigerated, the samples can be stored for several weeks). Good usability/handling, easy sampling, short sampling durations. No consumption of solvents. Good applicability in case of volatile substances and low substance concentrations in biogas. Special coating of metal surfaces prevents adsorption of reactive compounds. Sharp and well-defined peaks of VOCs due to the high heating rates of the TD-tubes and a cold trap during desorption.
Need for research	Validation of the method is still required.

In addition to the main components methane and carbon dioxide, biogas contains a series of volatile organic compounds (VOCs). This includes, among others, sulphur-containing compounds such as methanethiol, organosilicon substances (siloxanes) or terpenes such as limonene and pinene. The quantitative analysis of the VOCs can provide important indications regarding the processes in the digester and may help in the conceptualisation of necessary gas purification processes, where applicable. The concentrations of the individual VOCs in biogases typically amount to only a few ppm. Therefore, the enrichment of the VOCs in the so-called thermal desorption tubes (TD tubes) is sensible in order to improve the limit of detection and limit of quantification. The subsequent measurement of the VOCs is carried out by means of gas chromatograph mass spectrometer (GC-MS). The utilisation of an MS ensures a sufficient sensitivity of the method of analysis. Furthermore, it is possible to quickly identify unknown substances in a complex gas mixture qualitatively.

Sampling

The sampling is carried out with thermal desorption tubes made of stainless steel. These are coated with Silcosteel® in order to prevent reactive compounds from adsorbing on the metal surface and/or decomposing due to the high temperatures of the desorption process. The TD tubes contain a few mg of one or more adsorbents. In the latter case, the materials are layered one after another based on increasing adsorption strengths (“sandwich package”). This ensures that even particularly volatile compounds are retained in the last adsorbent layer of the tube.

The sampling and the subsequent measurement of the VOCs is carried out based on DIN EN ISO 16017¹. Prior to sampling, the TD tubes must be conditioned, i.e. they are heated in the laboratory at temperatures of 20–30 °C above the actual desorption temperature in order to remove any potentially adsorbed compounds. A TD tube conditioned in this manner is connected gas-tight on-site – with hoses made of Tygon® – to both the sampling site at the biogas plant/system and to the sampling pump. Tygon® hoses exhibit the necessary inertness for sampling. Additionally, a condensate trap can be installed between the sampling site and the tube in order to remove excess water vapour from the biogas that could disturb the adsorption process. It must be taken into consideration that polar compounds, such as alcohols, may be partially separated along with the condensated water. Before the TD tube is connected to the sampling point, all lines carrying gas as well as the condensate trap should be purged with biogas for 10 min in order to obtain a representative sample. When sampling, the exact volume flow is adjusted via a flow meter (Fig. 5.8-1).

Once the necessary flow-through has been set, a sufficient gas volume is suctioned into the tube. The amount of gas should be controlled such that the TD tube is not overloaded and that a breakthrough of the VOCs at the outlet of the tube is prevented. To check whether a breach occurred, two TD tubes can be connected in series. If VOCs are detected in the second TD tube, substances have broke through. The optimal flow rate and sampling duration depends on the individual gas composition at the respective biogas site and must be determined in preliminary tests, where applicable. Typical sampling durations are between 30 s and 10 min, wherein flow rates are adjusted between 50 and 100 mL min⁻¹.

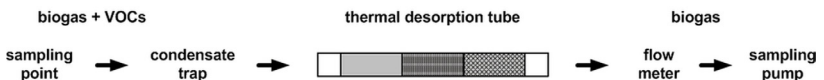

Figure 5.8-1: Schematic depiction of the VOC sampling with a 3-bed TD tube (Source: Fraunhofer UMSICHT)

¹ DIN EN 304:16017-1: "Sampling and analysis of volatile organic compounds by sorbent tube/thermal desorption/capillary gas chromatography - Part 1".

Thermal desorption and GC-MS measurement

The TD tube loaded with the material to be tested is slowly heated in the thermal desorption unit (TD unit) of the GC-MS to the final desorption temperature (300 °C). The desorbed VOCs are enriched in the carrier gas flow (helium) and are adsorbed onto TENAX® in the cold trap of the TD unit and are subsequently once again desorbed at a high heating rate. Through this step (focussing), afterwards narrow peaks in the chromatogram, i.e. well analysable substance peaks are achieved. All transfer lines and valves of the TD unit are also passivated with Silcosteel®. Finally the transfer to the GC, the separation of the VOCs on the capillary film column of the GC and the detection of the individual substances in the MS (Fig. 5.8-2) take place. For qualitative/quantitative analysis of the substance peaks, calibration curves are determined with the help of TD tubes that were loaded with liquid calibration standards.

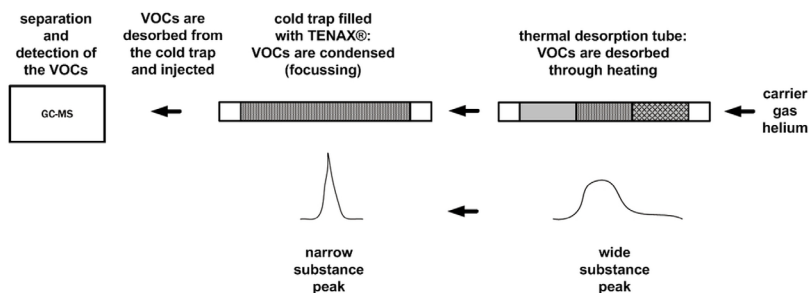

Figure 5.8-2: Schematic depiction of the thermal desorption with subsequent analysis
(Source: Fraunhofer UMSICHT)

Materials and devices

Calibration standards

Liquid calibration standards are commercially available and offered by a series of companies. Typically, these standards contain multiple VOCs, that are dissolved in a suitable solvent (e.g. methanol). Furthermore, it is also possible, to have manufacture custom-made calibration standards. All calibration standards feature a certificate so that they can be traced back to primary standards. The calibration standards typically feature concentrations of 1,000–5,000 µg mL⁻¹. For the dilution of calibration standards, highly pure solvents are required: e.g. methanol ≥ 99.9% and/or acetonitrile ≥ 99.8%. For the calibration of the GC-MS, 5 to 10 standard solutions that cover the anticipated concentration range must be prepared per calibration curve through dilution of the calibration standards. By the loading with the standard solutions, conditioned TD tubes are fixated on a special device (Calibration Solution Loading Rig). Afterwards, the required amount (usually 1 µL) of the respective standard solution is injected into the TD tube. By flushing with inert gas (helium or nitrogen), the excess solvent is removed from the TD tube. In this, a gas flow of 50–100 mL/min and a flushing duration of 20 s to 1 min has proven to be optimal.

TD tube

For the sampling, three different types of commercial TD tubes are utilised: TD tubes with Tenax® TA, 2-bed tubes with Tenax® TA and UniCarb™ as well as 3-bed tubes with Tenax® TA, UniCarb™ and Carboxen™-1000. Through the utilisation of multi-bed tubes, very volatile VOCs can be detected. However, since the post-treatment of these tubes is considerably more laborious than that of simple Tenax® tubes, they are only utilised when required, otherwise Tenax® tubes are predominantly used.

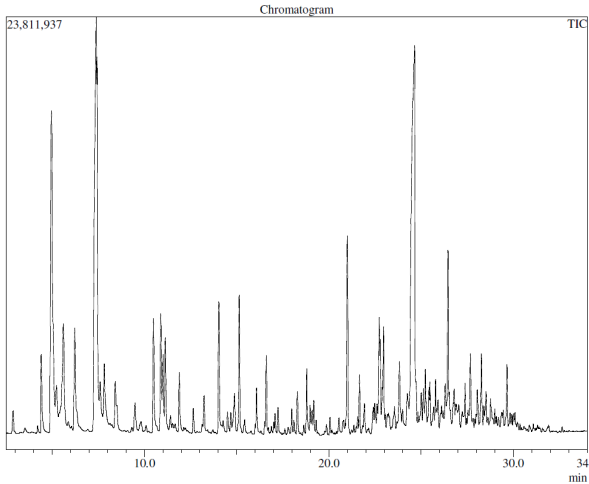

Figure 5.8-3: Chromatogram of a biogas sample (waste fermentation plant)
(Source: Fraunhofer UMSICHT)

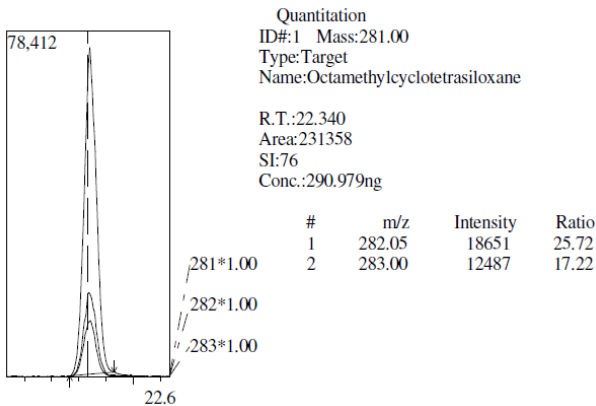

Figure 5.8-4: Quantification of octamethylcyclotetrasiloxane (D4)
(Source: Fraunhofer UMSICHT)

Measuring conditions and results

VOC samples and TD tubes loaded with standard solutions are analysed under the same conditions. Listed below are the optimized parameters of the instruments used, the GC-MS QP2010Plus and TD unit TD20 (both from Shimadzu), that have proven to be adequate for the measurement of the VOC samples and the loaded TD tubes (Tab. 5.8-1). These instrument-specific parameters must be adjusted and optimised for each GC-MS.

Table 5.8-1: Typical measuring conditions GC-MS

Device parameters GC-MS QP2010Plus	Settings
Oven programme	Start temperature 50 °C for 5 min 1. Hold ramp 5 °C min ⁻¹ to 200 °C, 15 min
Analytical separation column	Rxi5MS (Restek) or comparable column Length: 60 m*1.00 µm*0.25 mm Column flow: 2.43 mL min ⁻¹ , pressure 244.2 kPa Interface temperature: 250 °C, split ratio: 1:1 Carrier gas: helium Linear Velocity: 40 cm s ⁻¹
MS	Ion source temperature: 200 °C, Interface temperature: 250 °C, Detector voltage: 0.9 V Mode: Scan Mass range: 11–500 amu
Device parameters Thermal desorption	Settings
TD20	Desorption flow: 60 mL min ⁻¹ Desorption time: 5 min Desorption temperature: 300 °C Temperature of transfer line: 250 °C Temperature of cold trap: -15 °C Desorption temperature of cold trap: 300 °C, Desorption time of cold trap: 5 min

Depicted in a sample chromatogram is the VOC composition of a biogas sample from a waste fermentation plant. A TD tube with Tenax® TA was utilised for sampling. The sampling duration was 10 min and the gas flow as 100 mL min⁻¹, so that a gas volume of 1 L was sampled. More than 100 individual substances were identified (Fig. 5.8-1).

The advantage of the method presented is that even low VOC concentrations in the biogas can be determined with sufficient certainty. As such, for the organosilicon compound octamethylcyclotetrasiloxane (short designation: D4) an absolute amount of 290.98 ng was determined in the aforementioned sample (c.f. Fig. 5.8-2). This corresponds to a gas phase concentration of 24 ppb D4.

Quantification

The concentration of the compound to be tested in the biogas sample, C_m , in mg m^3 , is calculated based on the Eq. 16:

$$C_m = \frac{m_F - m_B}{V} \quad 16$$

m_F	Mass of the compound to be tested that was determined by means of GC-MS in the biogas sample (when two TD tubes were placed behind one another during sampling, the sum m_F must be calculated from the two individual values);	ng
m_B	Mass of the compound to be tested in the blind sample (if two TD tubes were placed behind one another, the sum m_B must be calculated from the two individual values)	ng
V	Volume of the sample	mL

Comment: If it is desired that the concentration information be put in relation to specific conditions, e.g. standard conditions $0\text{ }^\circ\text{C}$ (273,15 K) and 1013,25 mbar, the following conversion results:

$$C_c = C_m \frac{1013.25}{p} \cdot \frac{T + 273.15}{273.15} \quad 17$$

C_c	Concentration of the compound of the biogas sample to be tested, relative to specific conditions	mg m^{-3} [STP]
p	Atmospheric pressure	mbar
T	Actual temperature of the biogas sample	$^\circ\text{C}$

6 Methods for the determination of the physical parameters

6.1 Particle size distributions

Marc Lincke, Karin Jobst, Fraunhofer IKTS

Status	Under development/validation
Associated standards	Modelled after ISO 13320 (2009) and ISO 13322-2 (2005).
Area of application	<ul style="list-style-type: none"> ● Types of substrate: biogenous substrates of any composition ● TS range: 0–100 % ● Limitations of the method: measuring range of the particle size (0.1 μm–20 mm) ● Advantages: simple and robust method, wide measuring range
Need for research	Additional investigation, statistical substantiation as well as validation with model substrates of known granulometric composition in combination with corresponding mass balance calculations

Substrates, process media and incidental residues that occur in biogas production constitute very inhomogeneous material systems, which are characterised by irregular particle shapes and fibre structures as well as by a wide distribution of particle sizes. The knowledge and the adjustment of an optimal granulometric state is of great importance for the assessment as well as the optimisation of bioengineering processes that are related to biogas production. Especially for difficult to decompose and persistent substrates, the granulometric state has a direct impact on the biological decomposability as well as the viscosity and therefore it has an immediate influence on the mixing quality of the fermentation substrate.

At Fraunhofer IKTS it was possible, as a part of a joint project that was financed with funds of the European Union and the Free State of Saxony, to develop a measurement method together with a corresponding measuring guideline for these material systems. The scientific approach is characterised by a combination of different measurement methods and the particular results of each method are merged into a joint distribution graph. Since the material systems used in biogas plants in general feature high distribution ranges from the μm range to the cm range and therefore cannot be detected granulometrically with a single measurement method, this approach becomes inevitable. In a first step, the fractionation into coarse and fine share is carried out at a separating cut of 1 mm. The assessment of the fine share is performed by means of laser diffraction spectroscopy and the assessment of the coarse share with the help of a quantitative image analysis. The approach is explained in more detail below. In Fig. 6.1-1, the principle of the granulometric assessment in accordance with the measuring guideline of Fraunhofer IKTS is depicted.

The method introduced is currently being validated and investigated at IKTS in order to enable and ensure its widespread establishment.

Sampling and sample preparation

For a meaningful analysis, first and foremost a representative sample, which reflects the properties of the substrate in the silo and/or digester as best as possible, is important. The sampling, conservation and transport are carried out in accordance with the provisions of VDI GUIDELINE 4630.

Materials and devices

- analysis sieve (1 mm mesh width)
- beakers
- scale
- drying cabinet
- laser diffraction spectroscopy (Mastersizer S2000)
- quantitative image analysis system (FibreShape/QicPic)

Execution method

The substrate to be assessed is separated into a fine and a coarse share with the help of a sieve (1 mm mesh width). For this purpose, a defined quantity – depending on the type of substrate – is placed on the sieve and rinsed with water until no particles are visible any more in the residual rinsing water that already passed the sieve. For the analysis of the coarse fraction, a minimum of 3,000 assessable particles are needed. The investigations of Fraunhofer IKTS show that the sample and rinsing water amounts needed can differ widely, depending on the substrate. The sieve residue is dried in a drying cabinet until a constant weight is achieved.

Irrespective of the granulometric assessment of the fine and coarse fraction, the coarse substance share is calculated with the help of Eq. 23 and put in relation to the dry residue content, which is determined in accordance with DIN 38414 Part 2.

$$CS = \frac{(m_{\text{SieveDried}} - m_{\text{SieveEmpty}}) \cdot 100}{DR \cdot m_{\text{Content}}} \quad 23$$

CS	Coarse substance share	% _{DR}
$m_{\text{SieveEmpty}}$	Mass of empty sieve	(g)
$m_{\text{SieveDried}}$	Mass of sieve with dried sample	g
DR	Dry residue	%
m_{Content}	Mass of the content of the sample	g

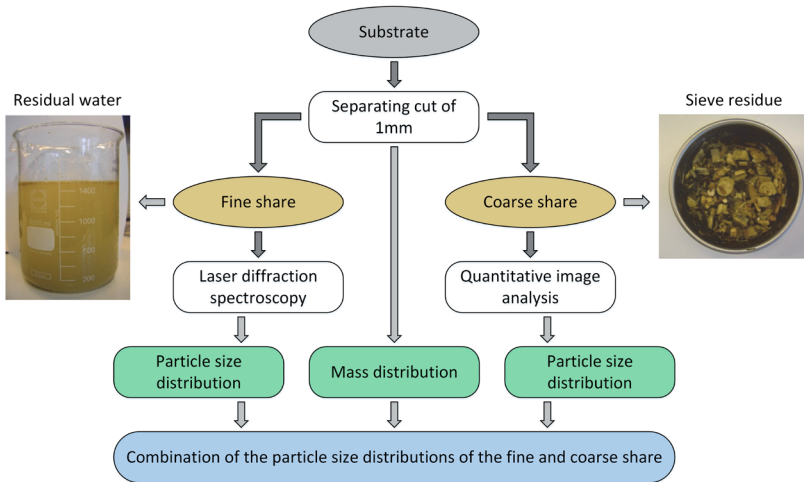

Figure 6.1-1: Principle of granulometric assessment (Source: IKTS)

The fine share in the rinsing water is measured directly after the sieving with the help of laser diffraction spectroscopy. In this measurement method, a monochromatic laser beam is diffracted by the particles contained in the suspension and the strength of the diffraction is indirectly proportionally dependent on the particle size. Particles with a larger diameter cause less diffraction of the laser beam. The diffracted light is measured by photo detectors which are mounted at different angles. With the help of the light diffraction theory, the particle size distribution can be calculated from the obtained diffraction image (angle-dependent light intensity distribution).¹ The measurements are carried out in accordance with an internal measuring guideline as well as on the basis of ISO 13320. Based on the evaluated laser diffraction, volume-equivalent particle sizes x_{EQPV} are calculated which can be depicted as density distribution $q_3(x_{EQPV})$ or as cumulative distribution $Q_3(x_{EQPV})$ (quantity type: volume). For further investigations, it is assumed that the sphere diameter x_{EQPV} is identical to the area diameter x_{EQPC} . The investigation of this empirical approach is currently carried out for biogenous substrates in on-going research activities.

The dried coarse fraction is characterised with the help of a quantitative image analysis. The measurement is carried out in accordance with an internal measuring guideline. As a result, a number distribution Q_0 of the particle contour data is available.

¹ http://www.malvern.de/ProcessGer/systems/laser_diffraction/technology/technology.htm (21 Dec 2011)

Data analysis

A prerequisite for the combination of two particle size distributions is the overlap of the measuring ranges of both methods, i.e. the maximum particle size of the fine share must be equal to or larger than the minimum particle size of the coarse share.

Furthermore, both distribution functions must feature standardised types of distributions as well as comparable dispersity parameters and/or particle sizes.

For this reason, a dispersity-size and type-of-quantity conversion of the distribution function of the coarse fraction is required. In the first step, the contour data of each particle is consolidated into a single value, the projection area identical diameter x_{EQPC} (c.f. Fig. 6.1-2), which is available as density distribution $q_o(x_{EQPC})$ and/or cumulative distribution $Q_o(x_{EQPC})$ of the type of quantity "number".

Subsequently, the conversion of the type of quantity from $e = 0$ (count) in $r = 3$ (volume) is carried out in accordance with the following equations:

$$q_r(x) = \frac{x^{r-e}}{M_{r-e,e}} \cdot q_e(x) \quad 24$$

$$M_{r-e,e} = \int_{x_{\min}}^{x_{\max}} x^{r-e} \cdot q_e(x) dx \quad 25$$

$$Q_r(x) = \int_{x_{\min}}^x q_r(x) dx \quad 26$$

x	Particle size
$q_e(x)$	Density distribution
$Q_e(x)$	Cumulative function
$M_{r-e,e}$	Momentum
Index e	Information regarding the existing type of quantity
Index r	Information regarding the sought-after type of quantity

If the particle size distributions of the fine and coarse fractions are subsequently available in the same type of quantity and feature equal dispersity parameters, both the density functions and/or the cumulative functions can be brought together into a single density function and/or cumulative function (c.f. Fig. 6.1-3) with the help of software tools and taking into consideration the quantity shares of the coarse and fine fractions derived from the parameter CS (Eq. 23).

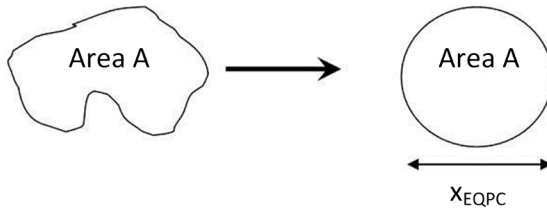

Figure 6.1-2: Diameter of the projection area identical circle (x_{EQPC}) (Source: IKTS)

Need for research

The methodology requires further investigation and statistical substantiation in the future. This is intended to be achieved through the application of the procedure to model substrates with known granulometric composition in combination with corresponding mass balance calculations.

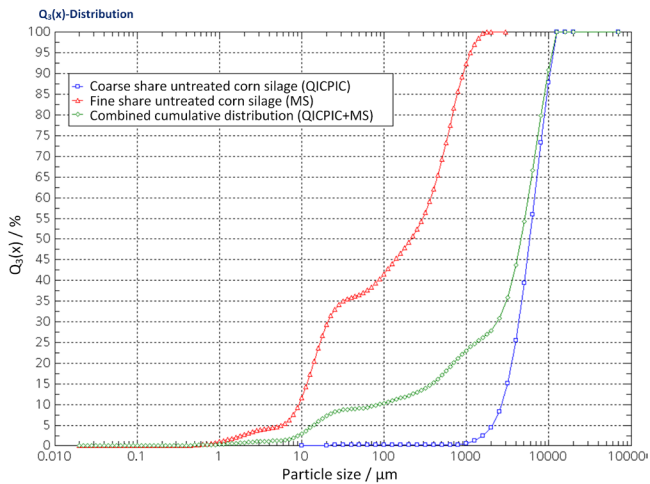

Figure 6.1-3: Cumulative distribution $Q_3(x)$ maize silage untreated (Source: IKTS)

6.2 Determination of the surface tension

Lucie Moeller, UFZ; Kati Görsch, DBFZ

Status	This method corresponds to the general standard.
Associated standards	Ring, plate and detachment method
Substrates/ materials	This method is suitable only for samples with total solids contents of up to approximately 6 %.
Measuring range	0.1–100 mN m ⁻¹
Disadvantages	In the case of two-phase samples (e.g. oil/water) the mixture may separate in the syringe during the measurement.
Advantages	No wetting problems Reduced sample volume (0.25 mL to 5 mL)
Need for research	For this method, there is no need for research.

The surface tension of a liquid is interconnected with the presence of surface-active substances. The lower the surface tension, the more easily the formation of foam may occur. To check the tendency of the fermentation substance to foam, its surface tension is determined with the help of a so-called drop volume method. The measuring principle is based on the formation of a drop at the end of a capillary, wherein the duration from the formation to the falling off of the drop depends on the surface activity of the tested liquid.

Processing of sample

For the determination of the surface tension, the centrifuge supernatant of the sample is being used. For this, the sample is centrifuged in 50 mL centrifuge tubes for 20 min at 5,300 rpm and 20 °C (device: Avanti 30 centrifuge, Beckman company). The supernatant is strained through a sieve (mesh width: 750 µm). To calculate the surface tension, the density of the sample is required. For this, the density of the centrifuge supernatant is determined by weighing out a specific volume (triple determination with calculation of the average).

Measuring process

As measuring device, a drop volume tensiometer (device: Lauda TV T-1, Lauda Dr. R. Wobser GmbH & Co. KG company) is being utilised. The device is controlled with the help of the Lauda software program (Version 2.2) (Lauda Dr. R. Wobser GmbH & Co. KG company). Approximately 2 mL of the centrifuge supernatant are pulled up with the syringe, mounted in the device and heated for at least 5 min to 26 °C. To calculate the surface tension, the density of the sample has to be typed into the program. For the determination of the surface tension, the following parameters are selected: Mode STD (standard mode with constant drip rate) and RED. on (reduction mode: uniform formation of individual drops). During the measurement, the surface tension of a total of eight drops is determined and averaged. Details regarding the measurement can be found in the operating manual of the device.

6.3 Determination of the foaming potential by means of the "bubble test"

Lucie Moeller, UFZ; Kati Görsch, DBFZ

Status	This method was developed for the determination of the foaming tendency of activated sludges.
Substrates and materials	No restrictions
Limitations of the method	The filter may clog and needs to be cleaned.
Need for research	For this method, there is no need for research.

Formation of foam in the process of anaerobic digestion is a frequent problem and can lead to serious operational problems (MOELLER & GÖRSCH 2015). However, research regarding foam formation during anaerobic digestion is relatively new. New methods for testing of the foaming tendency of substrates must be developed and/or methods from other disciplines must be tested for their utilisation in the field of anaerobic digestion. One to assess the tendency of a mixture to foam, and to assess the effectiveness of anti-foaming agents is the utilisation of the so-called "bubble test".

Description of the method

The tendency of a liquid mixture to form foam can be determined with the help of a foam generator. This is a measuring cylinder which, in its bottom area, is equipped with a diffuser stone for the injection of gas (Fig. 6.3-1).

50 mL of a liquid mixture (fermentation material or model foam with a stability comparable to that of the foam occurring in biogas plants, such as a 0.5% solution of protein powder in distilled water) are filled into the measuring cylinder. Through injection of nitrogen gas (10 L h^{-1}) over a defined period (5 min), the formation of foam is triggered in the prepared mixture. The foaming tendency, the foaming potential and the foam stability can be determined based on the foam development (GANIDI 2008).

The **foaming tendency** is determined as the height of the foam after five minutes of gasification, relative to the weight of the total solids in the fermentation material:



Figure 6.3-2: Foam generator with model foam (Source: UFZ)

$$\text{Foaming tendency} = \frac{h_{\text{foam}} [\text{mm}]}{m_{\text{TS}} [\text{g}]} \quad 27$$

The **foaming potential** is calculated after a 5 minute generation time as volume of the generated foam (V_{foam}), relative to the gas flow velocity (F_{N_2}):

$$\text{Foaming potential} = \frac{V_{\text{foam}} [\text{mL}]}{F_{\text{N}_2} [\text{mL}/\text{min}]} \quad 28$$

The **foam stability** is calculated as the volume of the generated foam ($V_{\text{foam}, t=1\text{h}}$) one hour after the gasification has ended, relative to the gas flow velocity (F_{N_2}):

$$\text{Foam stability} = \frac{V_{\text{foam}, t=1\text{h}} [\text{mL}]}{F_{\text{N}_2} [\text{mL}/\text{min}]} \quad 29$$

With this method, the effectiveness of the anti-foaming agents can be assessed, for instance. Model foam is well-suited for assessing the effectiveness of anti-foaming agents because the tests can be consistently reproduced. With the bubble test, the effects of individual anti-foaming agents can be easily seen (Fig. 6.3-2). The ratio of the foam-generating (protein powder) solution to the anti-foaming agent should correspond to the ratio commonly used in full-scale biogas plants (e.g. 0.002 Vol.%). The effect of the anti-foaming agent is then assessed based on the difference between the bubble test with and without the anti-foaming agent. In order to ensure the accuracy of the results, the each test should be repeated at least twice.

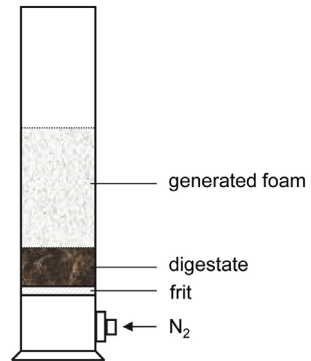

Figure 6.3-1: Scheme of the foam generator for the determination of the foaming potential of a liquid mixture (Source: UFZ)

6.4 LEIPZIG FOAM TESTER - Test set for the determination of the tendency of a substrate to foam

Lucie Moeller, Yvonne Köster, Andreas Zehndorf, UFZ

Status	The device is available from the Eismann & Stöbe GbR company.
Area of application of the method	Wet fermentation in mesophile and thermophile operation
Substrates and materials	Fermentation materials should have a TS content of less than 12%. All substrates can be tested, but in some cases they need to be disintegrated.
Limitations of the method	To date, there are no known disadvantages.
Advantages	Leipzig foam tester enables the detection of critical substrates before the use, the diagnosis of foaming causes in biogas plants as well as the optimization in safe test mode.
Need for research	For this method, there is no need for research.

Foam formation is among the most frequent upsets in biogas production via anaerobic digestion. Even though the consequences are very well known to plant operations, the actual causes of foam formation are often not understood. Biogas plants that utilise biogenous residues and waste materials are particularly affected by foam formation (MOELLER & GÖRSCH 2015). The main reason for this is found primarily in the the constant changing substrate quantity and quality. This method is particularly advantageous in that the foaming tendency of a new substrate (previously unknown to the plant operator) can be quickly and easily estimated before it is introduced to the digester.

Description of the method

The LEIPZIG FOAM TESTER (Fig. 6.4-1, MOELLER et al. 2015) is an easy-to-use test kit that can estimate the propensity of a substrate to produce foam during anaerobic digestion. The advantage of the test kit is that it is simple (complicated analysis is not needed) and was designed to be used on site

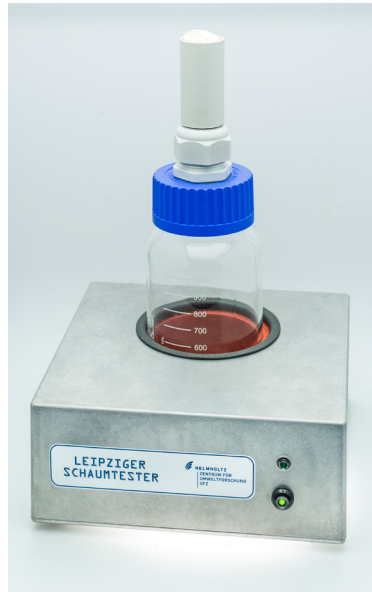

Figure 6.4-1: LEIPZIG FOAM TESTER
(Source: Künzelmann, UFZ)

by plant operators. Upon delivery of an unknown substrate, an aliquot is added to the active fermentation material and incubated at constant temperature for several hours. The test kit enables the operator to directly observe foam development. Based on the result of the test, plant operators can assess which steps should be taken in order to avoid a severe foam formation in the biogas plant.

Execution of the test

Preparatory measures

A sample of the fermentation material should be taken from the digester and, if the material appears to be nonhomogeneous, strained through a sieve (mesh width 10 mm). It is also advantageous to know the TS content of the substrate.

Carrying out the test (Fig. 6.4-2)

2% (w/w) substrate (relative to the TS content of the substrate) are weighed into the test bottle and mixed with active fermentation material. The final weight of the test mass (fermentation material) should be approximately 500 g. It is important that the contents of the bottle are thoroughly mixed prior to the start of the test. The test bottle, which is equipped with a lid with pressure release, and is closed and incubated in the LEIPZIG F OAM TESTER at either 37 °C (mesophile) or 55 °C (thermophile). The duration of the test is dependent on the activity of the fermentation material and the temperature of the mixture at the start

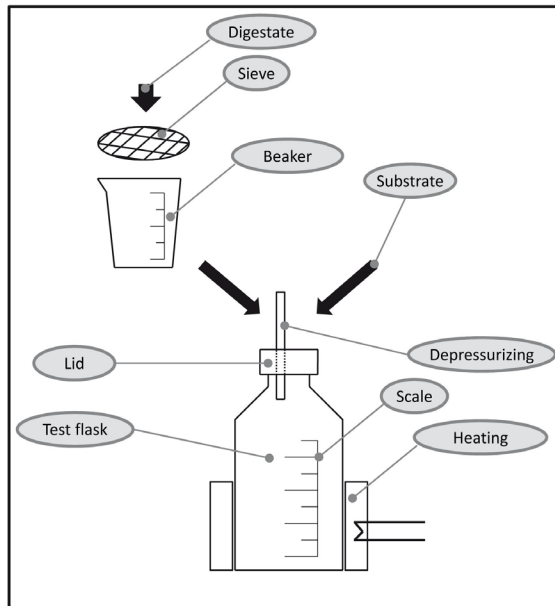

Figure 6.4-2: Test setup with labelling of the individual components (Source: UFZ)

of the test. It is advantageous to let the test run for at least 12 hours, but preferably for 24 hours. After the test is finished, the bottle can be removed and the intensity of the foam formation can be assessed. Since the existing fermentation material may also produce foam, a control test (without addition of the new substrate) should also be conducted. The intensity of the foam formation is calculated as follows:

$$\text{Intensity of the foam formation [\%]} = \frac{V_{\text{foam}} [\text{mL}]}{V_{\text{tot}} [\text{mL}]} \cdot 100 [\%] \quad \mathbf{30}$$

Protein powder may be used as a reference substrate. But in this case, only 1% protein powder (w/w) should be used since it causes a very severe foam formation. The use of protein powder enables different fermentation materials to be tested for their foaming propensity.

The method described may also be used to troubleshoot foaming events in biogas plants by retroactively testing problematic substrates. The fermentation material used in this case should feature properties (mesophile/thermophile, substrate matrix, TS content) similar to that of the fermentation material of the foaming plant. The fermentation material of an already foaming plant cannot longer be utilised for the determination of the cause. The viscosity of the source fermentation material plays an important role for the foaming tendency of the mixture with the respective substrate. The higher is the viscosity of the fermentation material, the higher the intensity of the foam formation in combination with the foam-provoking substrate. Since the viscosity cannot be measured by the plant operator, the TS content, which influences viscosity and can be easily measured, should be used as an indicator of viscosity.

6.5 Viscosity

Status	Under development/validation
Type of substrate	Biogenous substrates
Particle sizes	Maximum length = 50 mm (dependent on the measurement method)
Limitations of the method	High dynamic viscosities
Need for research	<ul style="list-style-type: none"> • Comparative tests between the systems and standardised measurements must be carried out by means of rotation viscometers. • Stirrer geometries for long-fibre substrates have to be developed. • Impact of the vortex formation on the torque as well as the mechanical correction for the determination of the apparent viscosity have to be investigated. • Transfer of the approach to industrial scale stirrers/pumps as an additional control parameter has to be carried out.

The viscosity and the flow behaviour, respectively, of the substrates utilised and of suspensions brought to fermentation determine, to a great degree, flow-engineering and material transport processes and have a strong impact on the biogas production.

Due to the complex composition of biogenous substrates (highly concentrated, long-fibred), commercial measuring system can be utilised only to a limited extent for the assessment of the flow characteristics of such material systems. To derive practicable measurement methods, systematic tests were carried out by different scientific institutions, whose results are presented in the following chapters. In this, it has to be taken into consideration that the measurement methods pointed out are always linked to defined conditions of use. Furthermore, it has to be noted that these, in part modified methods require further scientific tests and should therefore not be considered to be standardised measurement methods. Progressing insights and results of validation still to be carried out will be published at the appropriate time.

6.5.1 Measurement methods for the rheologic characterisation of fermentation substrates

Manuel Brehmer, Matthias Kraume, TU Berlin

For the rheologic characterisation of fermentation substrates, different devices, measurement methods and processes are available. In this, the correct choice depends on both the particle size and shape as well as the total solids content. However, since only an exact knowledge of the flow behaviour allows for an optimal operation of the mixing technology (KNOCH 1997), a recommendation for the selection of the suitable measuring system in dependence on the substrate composition is provided.

Quickly and precisely, the flow characteristics of shear thinning liquids such as fermentation substrates can be determined via rotation tests. For this, rheometers are available that consist of a drive unit and a measuring system. The latter, in turn, consists of two components, the measuring body and the measuring cup. Most of the industrially utilised **rheometers** work in accordance with the Searly method, i.e. the measuring body located internally (rotor) is in rotation while the exterior measuring cup is at rest (stator). The advantage of this setup is the option to heat the sample via the exterior, resting cylinder wall. Located in the gap between the rotor and the stator is the sample to be tested. In the case of the sufficiently tight annular gap between the measuring body and the measuring cup, and assuming wall adhesion, a linear velocity gradient in the gap can be assumed (MOSHAGE 2004). Through the measurement of the torque M required for the rotation in dependency on the rotational frequency N and/or the angular velocity ω , the shear stress τ and the shear rate $\dot{\gamma}$ can then be calculated. In order to take into account the different flow characteristics of the fluids, different measuring systems were developed and – for the most part – standardised. A differentiation is made between concentric, cone/plate, plate/plate and relative measuring systems (MEZGER 2006).

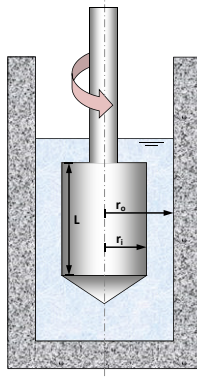

Figure 6.5-1: Cylinder measuring system (Source: BREHMER 2011a)

Among the classic, concentric measuring systems are the cylinder and the double gap measuring systems. Both are wide-spread in both industry and research. In addition to the easy handling and a quick, exact determination of the shear stress and the shear rate, the temperate impact can also be taken into consideration without a lot of effort.

The **cylinder measuring system** (c.f. Fig. 6.5-1) is described in the standards ISO 3219 and DIN 53019. It consists of a measuring body that rotates inside an exterior measuring cup. Both are located along a joint rotationally symmetrical axis. The shear stress and the shear rate can be calculated with the equations listed below.

$$\tau = \frac{1 + \delta^2}{2000 \cdot \delta^2} \cdot \frac{M}{2\pi L \cdot r_i^2 \cdot C_L} \quad 31$$

$$\dot{\gamma} = \omega \cdot \frac{1 + \delta^2}{\delta^2 - 1} \quad 32$$

The constant needed C_L is referred to as end-effect correction factor and takes into consideration effects at the end surface of the measuring system. Said factor is specified by the manufacturer. The maximum permissible ratio of the radius δ is also specified in ISO 3219 and amounts to:

$$\delta = \frac{r_o}{r_i} \leq 1.2 \quad 33$$

Often, the flow behaviour or laminar flow media is described in the literature not by the shear stress but rather via the dynamic viscosity η . It represents the molecular transport coefficient of the impulse (KRAUME 2004). In the case of non-Newtonian (n-N) liquids, the following connection exists between both parameters:

$$\tau = \eta_{n-N} \frac{dv_x}{dy} \quad 34$$

The index of the viscosity provides an indication for the fact it itself depends on the velocity gradient. In this case the viscosity is usually referred to as apparent viscosity.

$$\eta_{n-N} = f\left(\frac{dv_x}{dy}\right) \quad 35$$

In addition to the setup described, with a single annular space between rotor and stator, there are also concentric measuring systems with dual annular gap, so-called **double gap measuring systems**. In this, the measuring cylinder is a hollow cylinder. The exact

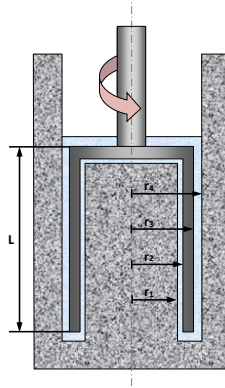

Figure 6.5-2: Double slit measuring system (Source: BREHMER 2011b)

characterisation is provided in the DIN 54453 standard. Due to its construction, (c.f. Fig. 6.5-2) with four wetted surface and a gap width $\delta \leq 1,15$ mm, higher shear rates can be generated at lower rotational frequency, and thereby low-viscosity fluids ($\eta < 100$ mPas) can be measured well. Depending on the torque and angular velocity, the shear stress and shear rate can be determined, too, in accordance with Eqs. 36 and 38.

$$\tau = \frac{1 + \delta^2}{(\delta^2 \cdot r_3^2 + r_2^2)} \cdot \frac{M}{4000 \cdot \pi L C_L} \quad 36$$

$$\dot{\gamma} = \omega \cdot \frac{1 + \delta^2}{\delta^2 - 1} \quad 37$$

$$\delta = \frac{r_4}{r_3} = \frac{r_2}{r_1} \leq 1.15 \quad 38$$

However, both of the classic systems introduced are only usable in a very limited range in the case of substrates, such as those found in biogas reactors. The reason is the narrow gap width, as a result of which only the liquid phase of the substrates can be measured. The solids can lead to friction on the cylinder wall which results in a higher torque and thereby in a higher viscosity. As an example, the viscosity graph of the double gap measuring system in Fig. 6.5-4 may be referenced. They nevertheless provide good results in the case of fermentation substrates such as sewage sludge, fats, and the biogenous residues of wet fermentation (c.f. Fig. 6.5-3 and Fig. 6.5-4). That is, substrates with flocs or very low solids contents. Additionally occurring effects such as Taylor vortex(es), sedimentation, or the destruction of flocs and as such the occurrence of thixotropy may additionally influence the

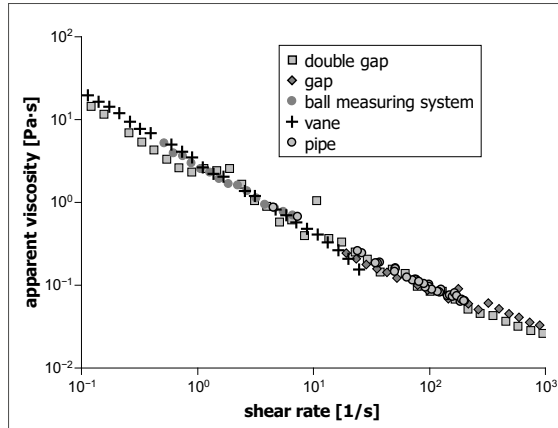

Figure 6.5-3: Comparison of different measurement methods using the example of sewage sludge (Source: BREHMER 2011a)

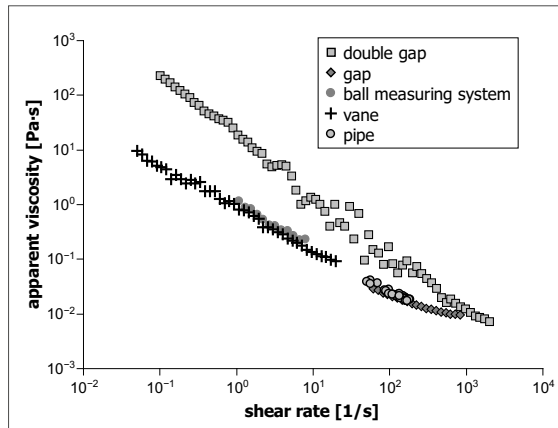

Figure 6.5-4: Comparison of different measurement methods using the example of a substrate mixture of sewage sludge, fats, and biogenous residues (Source: BREHMER 2011a)

measuring result. According to (MEZGER 2006), it applies as a rule of thumb that the particle size should not exceed $\frac{1}{10}$ the gap's dimension.

In addition to the concentric measuring systems, relative measuring systems are available, too, as previously mentioned. In contrast to the former, the latter do not feature clearly defined shear conditions (MEZGER 2006). At this point, the **stirrer** respectively a vane should be mentioned, here. Similar to the concentric measuring systems, the power input of the agitating mechanism depends, among other things, on the viscosity of the fluid to be stirred. This dependency can be described by the so-called performance characteristic.

This is the function connection between the dimensionless power number, also known as Newton number Ne , and the Reynolds number Re .

$$Ne = \frac{P}{\rho \cdot N^3 \cdot d^5} \quad 39$$

$$Re = \frac{\rho \cdot N \cdot d^2}{\eta} \quad 40$$

$$Ne = \frac{C_{lam}}{Re} \quad 41$$

The power input P is the result of

$$P = M \cdot \omega = M \cdot 2\pi N \quad 42$$

For non-Newtonian fluids, (METZNER & OTTO 1957) postulate that the dependency (Eq. 41) can also be utilised if the Reynolds number is built with an effective viscosity.

$$Re = \frac{\rho \cdot N \cdot d^2}{\eta_{eff}} \quad 43$$

However, in order to be able to calculate the effective viscosity η_{eff} from the Reynolds number, the constant C_{lam} of the stirrer used must be known in dependence on the geometrical conditions. It can be easily determined in advance utilising Newtonian fluids with known viscosity (c.f. Fig. 6.5-5).

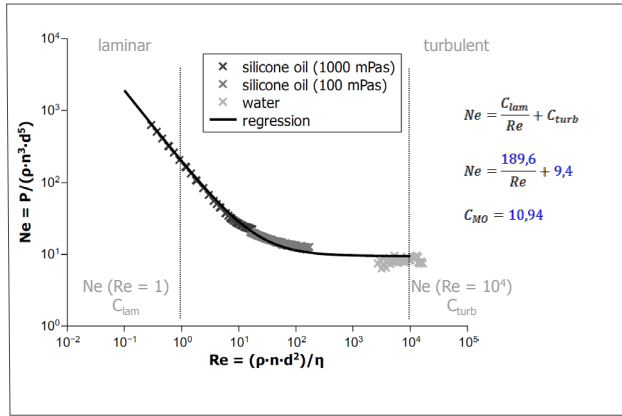

Figure 6.5-5: Example for the functional dependency of the power input on the Reynolds number for a vane (Source: BREHMER 2011b)

Finally, with the help of the Metzner-Otto method, (METZNER & OTTO 1957), a method for the calculation of the representative shear rate $\dot{\gamma}_{rep}$ is available. According to this, the representative shear rate in the laminar flow region ($Re \leq 10$) is proportional to the stirrer's rotational frequency:

$$\dot{\gamma}_{rep} = C_{MO} \cdot N$$

44

The proportionality, the Metzner-Otto constant C_{MO} , depends both on the stirrer used and the rheology of the fluid as well as the geometrical conditions, the stirrer diameter and the tank diameter. It can also be determined in advance with a non-Newtonian fluid whose rheology is known or at least easily measurable. A xanthan gum water solution may be referenced here as a potential liquid.

In addition, it must be taken into consideration that the method may lead to imprecise results in the case of substrates with a higher TS content ($TS > 6\%$). Due to differences in density within the suspension, a separation may occur. The wrapping of long fibre substrate components around the stirrer shaft (c.f. Fig. 6.5-6) during the measurement also leads to measuring inaccuracies (c.f. Fig. 6.5-7). However, according to MEZGER (2006) a calculation of viscosity and shear rate should be omitted completely and only the torque and the rotational frequency should be specified.

The **ball measuring system** was originally developed for the measurement of dispersions with particle sizes of up to 5 mm and is – just as the vane – one of the relative measuring systems (MEZGER 2006). In this measuring system, a ball of a precisely defined diameter is moved on a circular path with a defined track through a measuring cup. Since the sphere during the first round only encounters non-sheared sample material, it must be ensured that only one round is carried out. A heating of the substrate analogous to the vane is only



Figure 6.5-6: Wrapping of the vane shaft with long fibre substrate components (Source: BREHMER)

possible to a limited extent due to the required sample volume. Due to the torque and the rotational frequency, conclusions regarding the shear stress and the shear rate can be drawn analogous to the other rotation measurement methods and modelled after the Metzner-Otto method.

$$\tau = C_{SS} \cdot M$$

45

$$\dot{\gamma}_{rep} = C_{SR} \cdot N$$

46

The results shown in Fig. 6.5-3, Fig. 6.5-4 and Fig. 6.5-7 lead to the conclusion that the system is of limited suitability regarding the rheological characterisation of fermentation substrates. A particular disadvantage is the adhesion of solid particulates to the surface area of a ball (c.f. Fig. 6.5-8). This leads to an increase of the surface area of the ball and therefore to an increased torque.

For the exact rheological characterisation of substrates with higher TS contents, another method is available. Through **pressure loss measurements** in dependence on the volume flow, the viscosity and the shear rate can also be determined in a horizontal pipe. This does, however, require that the no-slip condition are applicable and that the flow characteristics of the fluid do not display any time dependence. Furthermore, it must be an established, laminar flow with parallel flow lines and constant velocity (WILKINSON 1960), (MALKIN & ISAYEV 2005).

The latter can easily be achieved by adherence to the upstream length z_{up} . It is calculated based on the following relationship:

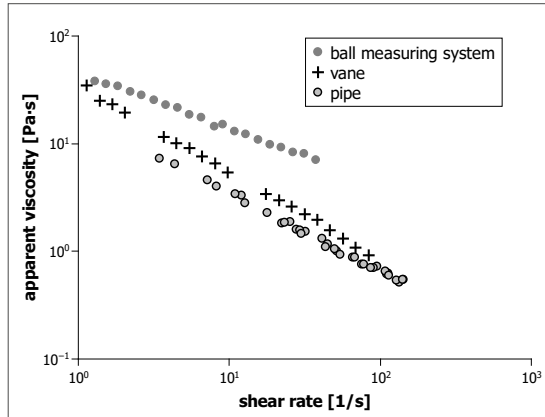

Figure 6.5-7: Comparison of different measurement methods using the example of a substrate mixture of maize silage and coarse rye meal (Source: BREHMER 2011a)

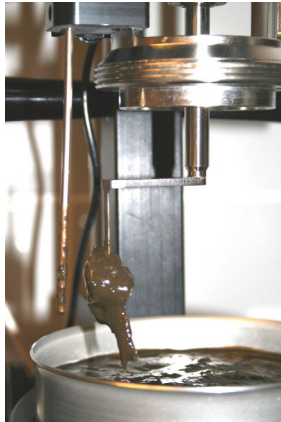

Figure 6.5-8: Adherence of solids to the surface of the ball (Source: BREHMER)

$$\frac{z_{up}}{d} \approx 0.058 \cdot Re$$

For the generation of the volume flow, pumps (TÜRK 1987) or compressed air (BREHMER 2011a) can be utilised. However, as an example, only the variant utilising compressed air (c.f. Fig. 6.5-9) will be covered in more detail, here. In this, the fermentation substrate is placed in a tank. Through the generation of a excess pressure in the inside of the tank,

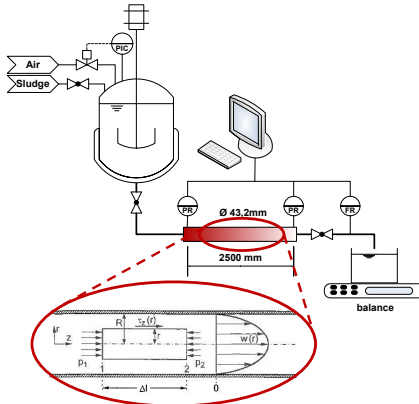

Figure 6.5-9: Flow diagram for the laminar flow tube (Source: BREHMER 2011a; KRAUME 2004)

different volume flows can be realised. In contrast to the pump, a pulsation is excluded this way. In order to compensate for the drop of the hydrostatic pressure during the measurement, the pressure must be regulated in dependence on the volume flow and the tank capacity.

Based on the assumptions listed above, the shear stress can be determined via a force balance (Eq. 48), and the shear rate can be determined utilising the METZNER-REED equation (Eq. 49).

$$\tau_w = \frac{d \cdot \Delta p}{4 \cdot L} = k' \cdot \left(\frac{8 \cdot v_{avg}}{d} \right)^{n'} \quad 48$$

$$\left(\frac{dv}{dR} \right)_w = \frac{3n' + 1}{4n'} \cdot \frac{8 \cdot v_{avg}}{d} \quad 49$$

$$n' = \frac{d \ln \left(\frac{d \cdot \Delta p}{4 \cdot L} \right)}{d \ln \left(\frac{8 \cdot v_{avg}}{d} \right)} \quad 50$$

The Term $\frac{8 \cdot v_{avg}}{d}$, where v_{avg} represents the average velocity of the fluid in the tube, has the same unit as the shear rate at the wall. For this reason, this term is referred to as apparent shear rate. It should be noted that Eq. 48 is only apparently similar to the Ostwald-de Waele relationship (c.f. Eq. 53). In general, n' is no constant, but rather dependent on $\frac{8 \cdot v_{avg}}{d}$. For the laminar and time-independent flow of a fluid, the exponent n' is defined as in Eq. 50. According to (WILKINSON 1960), the exponent n' and the factor k' for shear thinning fluids can be converted as follows into the flow exponent n and the Ostwald factor K :

$$k' = K \cdot \left(\frac{3n + 1}{4n} \right)^n \quad 51$$

$$n = \frac{n'}{1 - \frac{1}{3n'+1} \left(\frac{dn'}{dn} \right)} \quad 52$$

he biggest advantage of the tube viscometer is the possibility, in the case of a sufficient sizing of the system, to be able to still measure substrates with a high solid content and long, fibrous particles accurately. Only the increased time investment and the larger amount of substrate needed are contrasted to this.

In order to be able to compare the measuring points obtained – consisting of shear stress, shear rate, temperature, and measuring duration – with one another and mathematically describe them, different model functions were developed whose number by now, however, exceeds 20. CHEN suggests in his work dated 1986 to describe the flow behaviour of fermentation substrates with a dry matter content of less than 4.5% with the Power-law by Ostwald-de Waele. An approach which is by far used most often for the description.

$$\tau = K \cdot \dot{\gamma}^n \quad 53$$

For substrates whose dry matter content is above 4.5%, the approach of Herschel-Bulkley should be applied.

$$\tau = \eta_0 \cdot \dot{\gamma} + k'' \cdot \dot{\gamma}^{n''} \quad 54$$

Comparison measurements with all five measuring systems presented have shown that there is no measuring system that is equally well suited for the rheological characterisation of all substrates. Rather, the selection should be carried out in dependence on the TS content and the particle structure (BREHMER 2011b). Tab. 6.5-1 contains the corresponding information.

Table 6.5-1: Suitability of the measuring system for the rheological characterisation in dependence on the particle structure (BREHMER 2011b)

Particle structure	Pipe	Vane	Ball measuring system	Gap	Double gap
None	○	○	-	+	++
Flocs	○	○	-	++	+
Solid particles	+	+	○	○	--
Fibres (TS < 8%)	++	○	-	--	--

-- not suitable
- less suitable

○ suitable

+ well suitable
++ very well suitable

6.5.2 Modification of measuring systems for the application to flow behaviour determination of fibrous suspensions

Karin Jobst, Marc Lincke, Fraunhofer IKTS

A number of measurement methods and corresponding devices are available for the determination of the viscosity of suspensions. Typically, these methods are based on an assessment of the laminar velocity profile in a gap of known width. The gap width in turn depends on the measuring bob and measuring cup utilised and it determines the maximum particle size of the suspension to be assessed. With the rotational viscometer ViscoTester VT550, for instance, suspensions with maximum particle sizes between 0.1 mm (System NV) and 1.7 mm (System MV3) can be measured, depending on the cylinder measuring system selected. The tested biogenous suspensions typically contain particles with a fibre length of up to 50 mm and larger, which is why these cylinder measuring systems cannot be used. Due to the large number of particles within the gap, solid friction occurs, which distorts the measuring result. Additional measuring errors arise due to phase separations as a result of sedimentation in the cylindrical measuring cup. A separation of the larger particles in preparation of the measurement is not recommended, since these coarse particles have a considerable influence on the flow behaviour of the suspension. Due to these problems concerning the assessment of the flow characteristics of biogenous suspensions, intensive investigations regarding suitable measurement methods for fibrous fluid systems of substances with a maximum fibre length of 20 mm and/or 50 mm have been carried out at Fraunhofer IKTS as part of a collaborative project funded by the Free State of Saxony and the European Union. For the extension of the known standard measurement methods, two different measurement methods for long-fibre material systems have been developed, which are currently undergoing validation (c.f. Fig. 6.5-10). These two measuring approaches are introduced below.

Viscosity determination of fluid systems with fibre lengths of with $x_{\max} < 20 \text{ mm}$

A standard rotational viscometer with a 6-bladed stirrer (blade rotor FL10) is qualified for the assessment of the flow behaviour of fibrous suspensions with a maximum fibre length of 20 mm. For the adaptation of this measuring system to fibrous suspensions, a measuring guideline was developed at Fraunhofer IKTS.

The ViscoTester VT550 device used for this investigations is a Searle-type rotational viscometer in which the flow resistance of the test substance is measured against a specified rotational frequency. The torque required for maintaining the specified rotational frequency is measured via a stiff torsion-spring with a contactless sensor. The VT550 operates in a rotational-speed range of 0.5 to 800 min^{-1} , the range of the torque is between 0.01 to 3 Ncm. The internal control unit of the measuring device stores all data and calculates the values for the shear stress τ , the shear rate $\dot{\gamma}$ and the dynamic viscosity η with the help of the values of the measured torque M , the rotational frequency N as well as specific system factors (geometry) of the measuring system used. Reference to the apparent viscosity η_s is only made when the viscosity – in the case of the assessment of fermentation substrates – itself is dependent on the velocity profile and therefore does not represent a constant parameter.

The control of the device is exercised via an RS232 interface with the application software RheoWin. The determined data is available as ASCII files for further analysis and post-processing. To derive comparable results between the system selected here and known cylinder measuring systems, defined geometrical conditions regarding the measurement were introduced. In addition to the blade rotor FL10 ($D = 20$ mm) serving as rotor, a measuring cup with the dimensions of $D = 133$ mm and $H = 177$ mm is utilised as stator. Furthermore, the installation conditions of the blade rotor were defined and must be used for all measurements.

For the verification of the suitability of the system VT550-FL10, comparative measurements were carried out with a standardised cylinder measuring device (measuring system MV3) using suspensions with maximum particle sizes of 1.5 mm, whereupon the calculation of the flow curve and/or the viscosity is carried out in accordance with the calculation guidelines of the manufacturer of the measuring device, respectively. The results indicated a systematic error in the case of the measuring setup VT550-FL10. For this reason, another system factor F , which incorporates the geometrical conditions of the measuring setup, was determined for this system with the help of extensive comprehensive tests. This factor was implemented into the analysis, in addition to the system factor specified by the manufacturer, by subsequently converting the shear rates $\dot{\gamma}^*$ determined in accordance with the manufacturer's instruction in accordance with Eq. 55 and utilising it for the identification of the apparent viscosity $\eta_s = f(\dot{\gamma})$

$$\dot{\gamma} = F \cdot \dot{\gamma}^*$$

55

Sampling and sample preparation

For the viscosity measurement, a sample amount of 10 L is recommended, whereof 1.6 L are required per individual measurement. The sampling is carried out in accordance with VDI GUIDELINE 4630.

Prior to the retrieval of the sample for the measurement, the contents of the transport vessel must be homogenised in order to dissolve floating layers and settling layers.

Materials and devices

- measuring cup
- water bath with thermostat
- heating sleeve for breakers
- thermometer
- blade stirrer FL10
- ViscoTester VT550

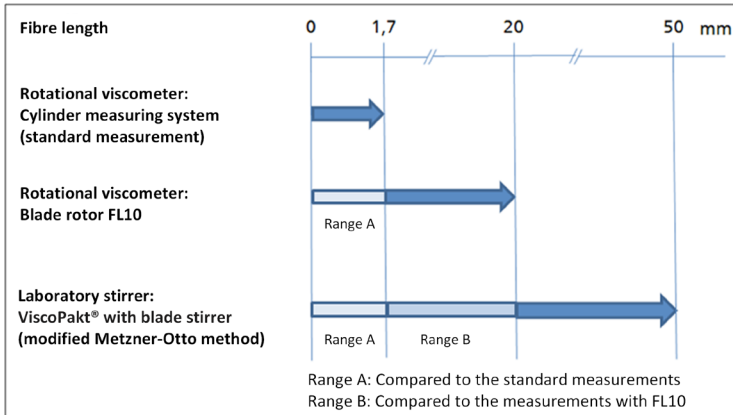

Figure 6.5-10: Measurement method(s) for the determination of the viscosity in dependence on the fibre length (Source: IKTS)

Execution method

Prior to the measurements, the samples to be inspected are heated to a defined temperature (e.g. process temperature) in a water bath. To reduce evaporation losses of the sample, the containers are covered. Subsequently, 1,600 mL of the heated sample are placed in the measuring cup. A constant temperature must be ensured during the measurement (utilisation of a thermostat and heating sleeves, if necessary). The temperature of the sample is measured before and after the measurement. In order to eliminate a significant temperature impact on the measuring result, the tolerated temperature change should not exceed 2 K (empirical value).

Once the measuring cup and the rotor have been positioned, the shearing range to be assessed and the number of measuring points to be selected are specified. The selection of at least one measuring point per second has proven to be useful. With the help of the rotational frequency, which is thereupon automatically applied by the measuring system, the torque recorded and the system factors stored in the system, the shear stress, the shear rate and the apparent viscosity can be determined. All measurements should be repeated at least three times (triple determination). In Fig. 6.5-12, the graph of the apparent viscosity is depicted for one fermentation substrate.

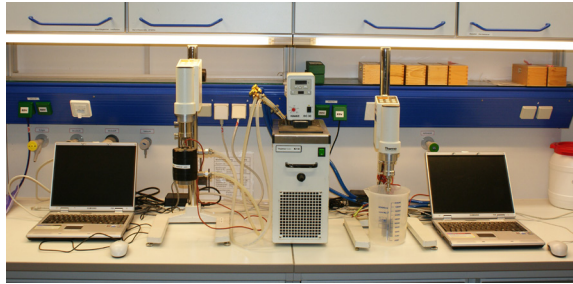

Figure 6.5-11: ViscoTester 550 with cylinder measuring device (left) and with blade stirrer FL10 (right) for the measurement of fermentation substrates (Source: IKTS)

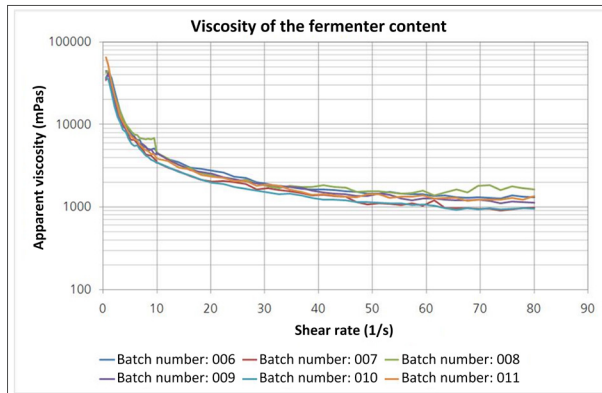

Figure 6.5-12: Viscosity curve of the digester content (Source: IKTS)

Since this measuring setup is a stirring system, a vortex formation may occur, depending on the sample's properties. Especially material systems with a low viscosity ($K_{1/s} < 2000 \text{ mPa}\cdot\text{s}^m$) tend to form severe turbulences in the measuring cup which generate an increase in torque, thereby pretending an increase in viscosity. In the case of a vortex formation in the measuring cup, the measured values are no longer usable. In the case of very fibrous substrates ($x_{max} > 20 \text{ mm}$), wrapping around the stirrer and the stirrer shaft may occur, whereby the stirrer geometry is changed and therefore the system framework conditions specified for the assessment are no longer applicable. In Fig. 6.5-13, both potential error sources are depicted.

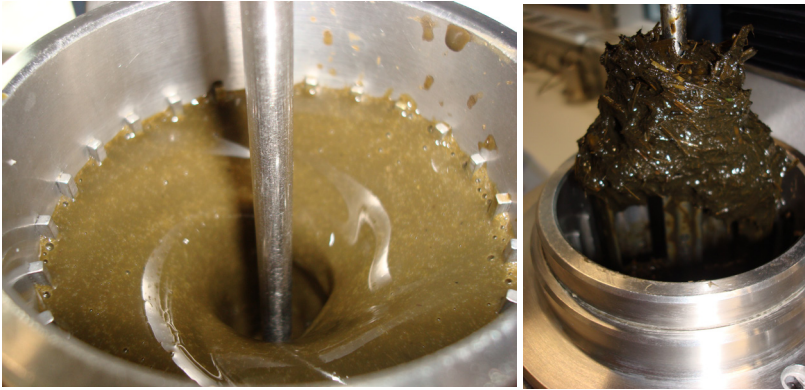

Figure 6.5-13: Faulty measurements due to vortex formation and wrapping around a stirrer shaft (Source: IKTS)

Need for research

To verify the additionally introduced system factor, further comparative tests have to be carried out between the VT550-FL10 system and standardised measurements by means of a rotational viscometer, taking into consideration applicable conditions of utilisation (c.f. Fig. 6.5-10). Furthermore, a comparison of the results to measurements of tube viscometers is useful.

Viscosity determination of fibrous material systems with $x_{\max} < 20 \text{ mm}$

Suspensions with fibre lengths larger than 20 mm cannot be tested with known standard measuring systems. The geometry of the measuring device must be adjusted to the proportions of the particles contained in the suspension. For suspensions with a maximum particle size of up to 50 mm, laboratory stirrers with a torque measurement and recording are suitable. In the view of this background, a method for viscosity determination based on the METZNER-OTTO method was developed at Fraunhofer IKTS as part of a group project funded by the European Union and the Free State of Saxony.

Modified METZNER-OTTO method for the determination of the viscosity

The foundation for this modified method is the relationship between the stirrer's rotational frequency N and the shear rate $\dot{\gamma}$. Through the utilisation of a suitable stirrer system, the corresponding Newton numbers Ne and Reynolds numbers Re are determined for defined stirrer tip-speeds u and average apparent viscosities η_s . Foundation for this are the performance characteristics of the stirrer system to be determined with a Newtonian fluid. By recording the power that a stirrer needs for stirring the medium to be characterised, the Newton number corresponding to the stirring process can be derived and therefrom the effective Reynolds number with the average apparent viscosity η_s (c.f. Fig. 6.5-14). For the conversion of the relationship of $\eta_s = f(N)$ into the known dependency of the apparent viscosity on the shear rate $\eta_s = f(\dot{\gamma})$, METZNER & OTTO utilised proportionality constants, the

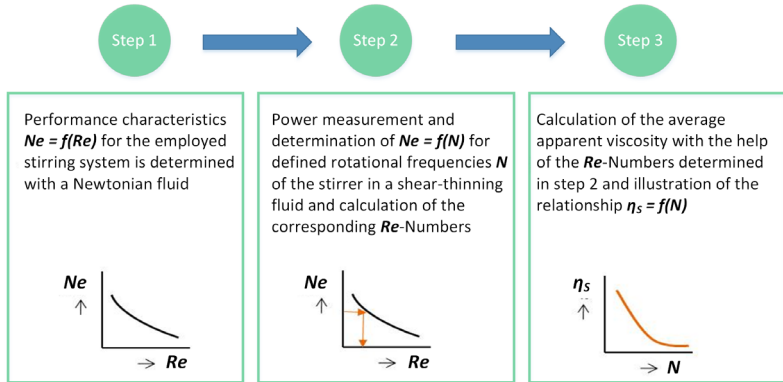

Figure 6.5-14: Approach for the determination of the viscosity according to METZNER & OTTO

so-called Metzner-Otto constants k_{MO} , that are dependent on the stirrer used. Newer tests (PAWLOWSKI 2004) discussed this concept rather critically, since the Metzner-Otto constant built as proportionality factor between the stirrer rotational frequency and the shear rate is not only dependent on the stirrer geometry, but also on the rheological behaviour of the fluid.

With the help of systematic tests at Fraunhofer IKTS, the additional influence of the rheological behaviour and therefrom a possibility for the conversion of the relationship $\eta_s = f(N)$ into the form $\eta_s = f(\dot{\gamma})$ was determined.

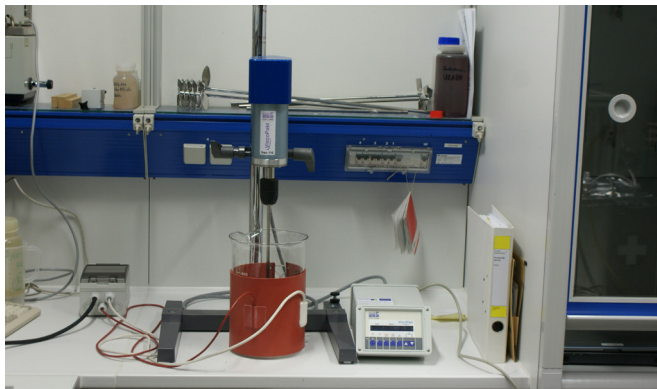

Figure 6.5-15: Test bench for the determination of the apparent viscosity in highly concentrated, fibrous suspensions (Source: IKTS)

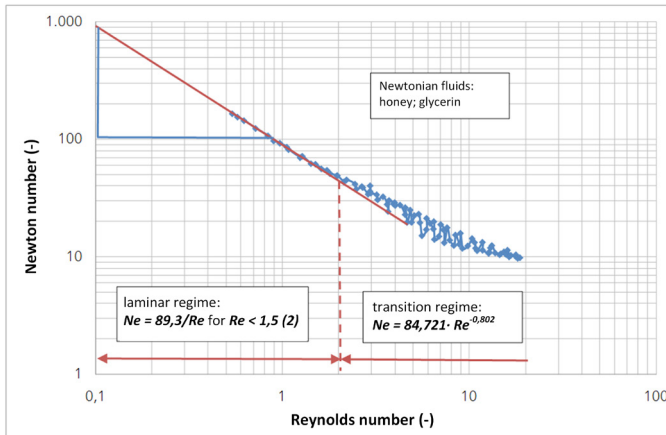

Figure 6.5-16: Performance characteristics of the stirrer system utilised for the viscosity measurement (Source: IKTS)

Measuring system ViscoPakt® laboratory stirrer

For the specific tests, a ViscoPakt®-laboratory-stirrer is used, which is equipped with a simple torque measurement. Changes of the rotational frequency due to load variations are compensated electronically. The stirrer drive is equipped with interfaces for the continuous recording of the rotational frequency and the torque. A maximum torque of 110 Ncm can be measured at a resolution of 0.2 Ncm.

The stirrer system consists of a blade stirrer with a diameter of 70 mm and a SCHOTT laboratory glass 5,000 mL as stirred reactor. The aspect ratio utilised between fill level and reactor diameter is 1.0. The placement of the stirrer was carried out centric and the distance between the stirrer and the bottom of the reactor was held constantly at 28 mm. For the stirrer system described, the performance characteristics $Ne = f(Re)$ depicted in Fig. 6.5-16 were determined, which constitute the foundation of the viscosity determination via the stirrer torque.

For different rotational frequencies N in the range of 30 to 700 min^{-1} , the torque M was measured and therefrom the input stirrer power P as well as the Ne number is determined in accordance with the following equations:

$$P = 2\pi \cdot M \cdot N \quad 56$$

$$Ne = \frac{P}{\rho \cdot N^3 \cdot d^5} \quad 57$$

The stirrer diameter is referred to as d and the density of the material system to be assessed as ρ .

Utilising the performance characteristics, the apparent viscosity can be determined for highly concentrated suspensions with fibre lengths of up to 50 mm in dependence on the stirrer rotational frequency of the blade stirrer employed, in accordance with steps 2 and 3 depicted in Fig. 6.5-14.

$$\text{Ne}(N) \Rightarrow \text{Re}(N) \Rightarrow \eta_s(N) = \frac{\rho \cdot N \cdot d^2}{\text{Re}} \quad 58$$

Through the utilisation of the functional relationships mentioned in Fig. 6.5-16 and Eq. 6.5-19, the functional relationship between the apparent viscosity and stirrer rotational frequency $\eta_s = f(N)$ was determined for the material system tested. The hydrolysate of a biogas plant can be described with the functional relationship shown in Fig. 6.5-17, for instance.

In addition to the maximum particle size of approx. 50 mm, the degree of the viscosity must be specified as additional limitation of use for the measuring system depicted. In the case of substances with $\eta_s < 1,000$ mPas, the formation of turbulences may already occur at low stirrer rotational frequencies, which would falsely mimic an increase in viscosity (Fig. 6.5-18).

To determine a potentially existing relationship between $\eta_s = f(N)$ and $\eta_s = f(\dot{\gamma})$, measurements with a rotational viscometer ViscoTester VT550 were carried out in addition to the tests performed by means of the ViscoPakt®- laboratory stirrer. Prerequisite for these comparative measurements was, that no exceeding of the limitations of use existed regarding the particle size and solids concentration of the examined substances. Considering the established statements proposed in literature regarding the fact that the relationship between the stirrer rotational frequency and the shear rate is, in addition to the stirrer geometry, dependent on the rheological properties of the employed substances, great attention was paid to the selection of the material systems.

According to the approach of OSTWALD-DE-WAELE, the employed material systems feature significant differences in respect of their flow exponent n . So far, the flow exponent has been varied between -0.2 and 0.7 .

$$\eta_s = K \cdot \dot{\gamma}^{n-1} \quad 59$$

A comparison of the flow curves $\eta_s = f(\dot{\gamma})$ determined by the ViscoTester 550 with the measuring results of the ViscoPakt® laboratory stirrer $\eta_s = f(\dot{\gamma})$ showed that both measuring systems describe the viscosity of each of the tested material systems with comparable flow curves. The relationship determined by the ViscoPakt® laboratory stirrer can be described with

$$\eta_s = K^* \cdot N^{n-1} \quad 60$$

whereby a simple equating of the flow functions $\eta_s = f(\dot{\gamma}) = f(N)$ was made possible. A rearrangement of the equations for $\dot{\gamma}$ provides the factor K_{VP} for each tested material system. With the factor K_{VP} , the employed rotational frequencies of the stirrer can be converted into the corresponding shear rates.

$$\dot{\gamma} = K_{VP} \cdot N \quad 61$$

Since the geometrical dimensions of the stirrer system remained constant for all tests, it was possible to trace back K_{VP} to the sole dependence on the flow properties in the form of the flow exponent n , which therefore can be calculated via the empirically determined relationship.

$$K_{VP} = 8.52 \cdot n + 6.8 \quad 62$$

The flow exponent n is identified via the exponents of the flow function (Eq. 60) determined by measurements with the ViscoPakt® laboratory stirrer.

Sampling and sample preparation

A sample amount of 30 L is recommended for the viscosity measurement, wherein 3.5 L are required for each individual measurement (repetition measurements are reconsidered). The sampling is carried out according to VDI GUIDELINE 4630. A special sample preparation for the measurements is not required.

Materials and devices

- measuring cup
- blade stirrer
- stirrer with torque measurement (ViscoPakt 110)
- heating sleeve
- thermostat and thermometer
- scale and measuring cylinder (determination of density)

Execution method

The samples are heated to the desired temperature in a water bath in a closed container. Once the sample has reached the desired temperature, 3,500 mL are filled into the measuring cup. This measuring cup is equipped with a heating sleeve in order to minimise the heat loss during the measurement. Subsequent to the positioning of the measuring cup and the blade stirrer, the rotational frequency is increased in defined steps (e.g. $\Delta N = 10 \text{ min}^{-1}$) and the related torque is recorded. With the help of the rotational frequency and the measured torque, the apparent viscosity can be calculated in accordance with the method described above. The temperature of the sample is checked before and after the measurement and should be deviating from the initial value by less than 2 K (empirical value). Depending on the viscosity, the formation of vortices may occur during

the measurement, which leads to a disproportionate increase of the torque due to the turbulent flow regime (Fig. 6.5-19, right). Analogous to the measurements with the blade rotor (c.f. section "Viscosity determination of fibrous material systems with $x_{\max} < 20 \text{ mm}^3$ "), this increase leads to an increase of the apparent viscosity at higher rotational frequencies/shear rates in the further calculation. As soon as a macroscopic vortex forms, the measured

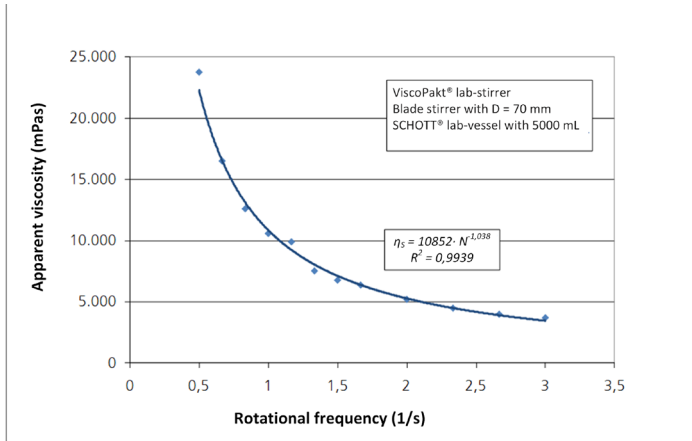

Figure 6.5-17: Apparent viscosity in dependence on the rotational frequency for the hydrolysate of a biogas plant (Source: IKTS)

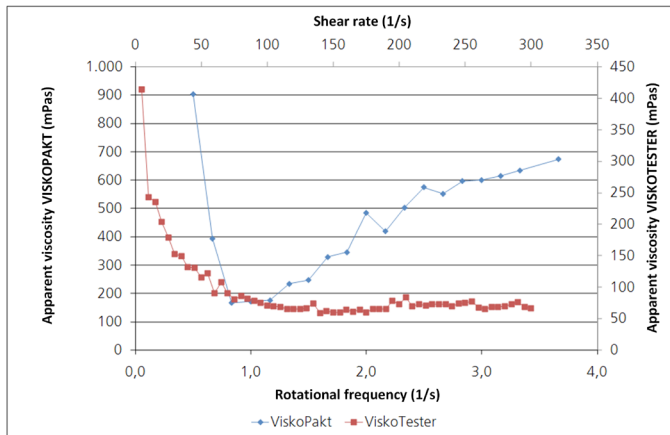

Figure 6.5-18: Faulty assessment of the viscosity for low-viscous material systems in the case of utilisation of the ViscoPakt®-laboratory stirrer (Source: IKTS)

values are no longer analysable. In the case of fibre lengths larger than 50 mm, wrapping around the stirrer blades and the stirrer shaft may occur, whereby the measurement of the torque is falsified (Fig. 6.5-19, left). These measurements must be discarded.

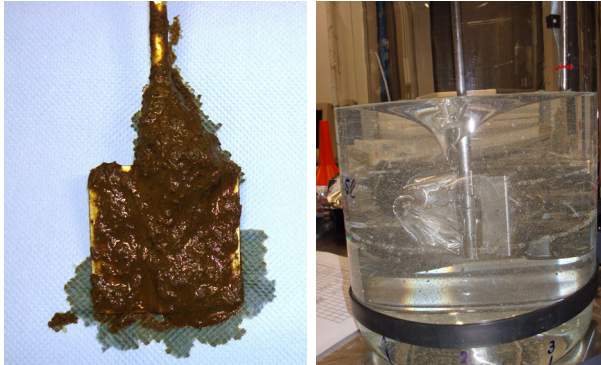

Figure 6.5-19: Wrapping around blade stirrer and vortex formation (Source: IKTS)

Need for research

- development of stirrer geometries for long-fibre substrates
- investigation of the impact of vortex formation on the measured torque as well as the mathematical correction for the determination of the apparent viscosity
- transfer of the approach to industrial scale stirrers and pumps as an additional control parameter

6.6 Flow analysis

From the point of view of a best possible decomposition of the raw materials used, the efficient mixing of biogas reactor constitutes an important focus. An essential prerequisite in this is to ensure a mixing of the reactor volume that is a complete and as homogeneous as possible. This process engineering state cannot be realised in practical operation despite very high energetic expenditures. The mixing processes require up to 55% of the electricity generated in-house by the biogas plant. The recording of the mixing state in bioreactors via measuring equipment is therefore even more important.

Flow analyses and/or velocity measurements can be carried out both on industrial-scale biogas reactors as well as on systems at a pilot plant scale. For this, different measuring techniques are available which will be covered in more detail in the following two sections. The deciding factors for the selection of the measuring technique are the measuring range and the accessibility of the systems.

Known commercial measuring systems such as sensors or optical measurement methods allow for both exactly localised as well as global considerations of the mixing state. In this, it must be differentiated between the measuring technique for utilisation at pilot plant scale and that at industrial scale reactors. For the application case mentioned first, measuring systems have to be relied on that can still detect velocities in the mm s^{-1} range. Here, constant temperature anemometry and particle image velocimetry, among other, have proven to be suitable. Both measurement methods require the use of a transparent model medium. The selection of the velocity measuring technique for industrial scale biogas reactors has proven disproportionately more difficult. Due to the high solids content, the use of permanently installed measuring technology is not possible at present. However, with MID measuring sensors or vanes, devices are available for mobile, short-term use.

For process-engineering application, tomographic measurement methods have already been used for quite some time for the measurement of temperature, concentration, and velocity fields. In the area of biogas engineering, i.e. for the investigation and assessment of mixing processes in biogas reactors, the use of this measuring technique is new. In addition to the location-resolved view of the mixing states, the advantages of this method are both a utilisation of model fluids as well as of the opaque fibrous original substrates occurring in the biogas sector.

6.6.1 Utilisation of measuring sensors

Manuel Brehmer, Matthias Kraume, TU Berlin

Flow analyses and/or velocity measurements can be carried out both on industrial-scale biogas reactors as well as on systems at a pilot plant scale. For this, different measuring techniques are available which will be covered in more detail in the following two sections. The deciding factors for the selection of the measuring technique are the measuring range and the accessibility of the system.

Measurements at industrial scale systems

For the measurements at industrial scale systems, a vane anemometer developed by Fraunhofer Umsicht (DEERBERG et al. 2009) can be relied on. This anemometer consists of a lance on which a vane is mounted at its end (c.f. Fig. 6.6-1). The setup allows for the measurement also in coarse particular media as they are found in biogas reactors. Utilised for this is the magnetic induction. With each passing of the vanes through the magnetic field, a signal is generated. From the frequency of the signalling, the velocity of the fermentation substrate can be determined subsequently. According to the manufacturer, velocity as low as 1.2 mm s^{-1} can be detected this way. Prerequisite for the utilisation of this measuring technique is, however, a connecting branches and an adequate sealing of the sensor against exiting of the substrate and/or biogas. Since the sealing towards the liquid phase can be realised significantly easier, it is therefore recommended to utilise an connecting branches below the liquid level. Concomitantly, the risk of a methane emission is also reduced significantly this way. In order to remove particles that get trapped between the vanes and the wall of the sensor, the sensor can be flushed through a nozzle located behind the vane. So that the sensor does not have to be completely removed for each flushing process, the use of a lock chamber is recommended. This way, the necessary sealing can also be achieved concomitantly. In Fig. 6.6-2, an example of such a lock chamber is depicted. It consists of two pinch valves, a transparent PVC pipe equipped with inlet and outlet, and three round flanges. The latter ensure a centring of the sensor. By introducing an O-ring with the diameter of the sensor, and additional sealing is effected. The pinch valves are controlled by a proportional valve. Due to the transparent PVC pipe, the degree of soiling and the functionality of the vane can be checked and remedied without completely removing it.

Flow analyses in a pilot scale

For the flow analyses in the pilot plant scale, optical methods of measurement and thermoelectric anemometry are available, among others. With both methods it is possible to exactly determine even low velocities such as they occur in biogas reactors. Commercially available vanes are error-prone due to the shear thinning flow properties of the fluids. General information regarding flow measurement methods can be found in the publications of (NITSCHKE & BRUNN 2006), (ECKELMANN 1997), (HERWIG 2006) and (DEBATIN 1997). For more in-depth literature, in particular in the area of thermal anemometry, please see the works of (LOMAS 1986) and (TISI 2008). The literature sources mentioned above also serve as foundation for the sections below.



Figure 6.6-1: Sensor head of the vane anemometer for the measurement of the velocity in industrial scale biogas plants; built by Fraunhofer UMSICHT (Source: TU Berlin)



Figure 6.6-2: Example of a lock chamber for rinsing and sealing of the sensor (Source: TU Berlin)

In addition to the previously mentioned decisive capability to be able to exactly determine slow velocities, both the optical measurement methods as well as the thermoelectric anemometry, however, also feature two disadvantages: They are sensitive to particles and especially in the case of the optical velocity measurements, a transparent medium must be utilised. However, since the fermentation substrates of biogas reaction are neither transparent nor particle-free, substitute with identical flow characteristics (shear thinning flow behaviour) must be utilised. One option is the addition of additives to the water. Xanthan gum may be referenced here as an example. Xanthan comes from the foodstuffs industry and is available on the market, among other ways, as a transparent additive (e.g. from the COLLTEC GmbH & CO.KG company) and can be mixed with water at different concentration ratios. As such, it allows for the setting of different viscosities and to address the differing conditions at the biogas plants (c.f. Fig. 6.6-3). Another option is the use of substances from the cosmetics industry. These are non-perishable and therefore easier to handle. An example to be mentioned here is Merat 550, a basic component of shampoos.

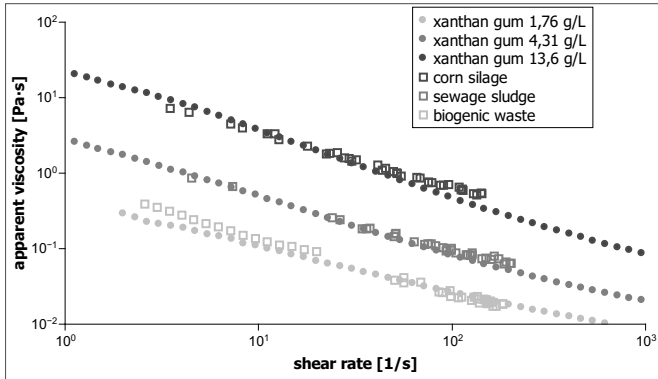

Figure 6.6-3: Comparison of the flow characteristics of substrates and substitute media
(Source: BREHMER 2011c)

Optical measurement methods

The optical measurement methods use laser light, wherein a differentiation is made between laser-2-focus anemometry (in short: L2F), laser Doppler anemometry (in short: LDA) and particle image velocimetry (in short: PIV). The great advantage, in contrast to thermoelectric anemometry, is that the capturing of measured data does not influence the flow. The disadvantage, however, is the high price of considerably more than 50,000 Euro and the large amount of equipment needed.

In all optical measurement methods, seeding particles, are utilised. They must fulfil two complementary conditions:

- a slip-free movement with the flow
- a good dispersion of the laser light

Furthermore, the volume to be measured must be optically accessible. Here, problems arise in particular in the case of round tanks since they cause an additional dispersion of the laser light. However, this dispersion can be compensated for by the analysis software to a certain degree. Alternatively, the cylinder can be placed in a cubic container and the space in between filled with water or glycerin. The PIV method will be covered in more detail as an example of the optical measurement methods. It is characterised, first and foremost, by the possibility to measure whole velocity fields in a single sectional plane. Via a laser, light of a high intensity is projected onto the sectional plane. It is scattered orthogonally by the particles (c.f. Fig. 6.6-4). Through the correlation of two captured images, a velocity field can be generated at the computer due to the distance passed by the particles. In the correlation, the captured images are split into analysis fields. The size of the analysis field therefore determines the resolution of the velocity field. It must, however, not be selected too small since the fields are analysed via statistical methods. If too few seeding particles are in a field, no average shift of the particles can be determined in this field. In reverse to

L2F anemometry, a time is specified and the distance is measured. To capture the images, digital cross-correlation cameras (CCD) are often utilised. Nd:YAG double pulse lasers are often utilised. The temporal resolution of the PIV depends on the CCD utilised which, nowadays, can capture up to 7,000 images per second.

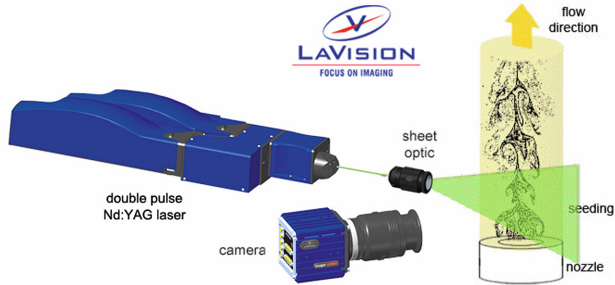

Figure 6.6-4: System components of Particle Image Velocimetry (Source: Lavison GmbH 2018)

Thermoelectric anemometry

Thermoelectric anemometry detects the flow velocity via the proportional relationship to convective heat transfer due to a temperature gradient between the measuring sensor and the flow. In this, a differentiation is made between constant current anemometry (CCA), pulse wire anemometry and constant temperature anemometry (CTA). A big advantage of this measurement method is the high resolution of the measured data, which – at up to 400 kHz – also allows for the utilisation for the measurement of turbulences. It is also a very inexpensive instrument, given its accuracy. In comparison to the PIV, the price is only approx. 10,000 Euro. The signal process is in all cases carried out by a Wheatstone bridge (c.f. Fig. 6.6-5). With the hot-wire sensor and/or hot-film sensor, three different parameters can be determined:

Velocity

$$U \sim v^n \quad \text{for} \quad n < 1; p, \Delta T = \text{const.}$$

63

Mass flow

$$U \sim (\rho v)^n \quad \text{for} \quad n < 1; p, \Delta T = \text{const.}$$

64

Temperature difference

$$U \sim T \quad \text{for} \quad \rho v = \text{const.}$$

65

The presently most common method of thermoelectric anemometry is that of the constant temperature anemometer. In the case of a change of the flow velocity, the keeping constant of the sensor resistance leads to a changed voltage which can be directly measured and transformed. The constant temperature and the constant sensor resistance are automatically adjusted via a control circuit.

The exact relationship between velocity and heater voltage then results via

$$U^2 = C_1 + C_2 \cdot v^n \quad 66$$

The constants C_1 and C_2 must be determined empirically in advance. They depend on the media, the sensor temperature (T_s) and the fluid temperature (T_f), as well as the operating/sensor resistance (R_s), the projected area (A_s) and the diameter of the sensor (d_s).

$$C_1 = f(T_s, T_f, R_s, A_s) \quad 67$$

$$C_2 = f(T_s, T_f, R_s, A_s, v, d_s) \quad 68$$

The exponent n depends on the flow state and-or on the Reynolds number. The heater voltage (U) of the sensor is directly linked to the bridge voltage (U_B) of the Wheatstone bridge (c.f. Fig. 6.6-5) that can be measured.

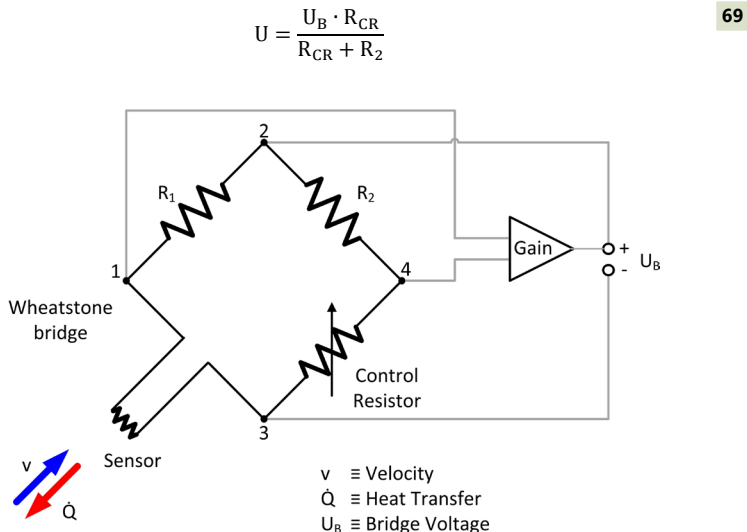

Figure 6.6-5: CTA Wheatstone bridge

For the calibration of each sensor and/or for the determination of the constants, towing-channel can be utilised. One such towing-channel is depicted in Fig. 6.6-6. In this, during the measurement the sensor is pulled through a tube at an exactly controllable velocity. Through multiple repetitions at different velocities, this way the calibration curve for the calculation of the velocity in dependence on the heater voltage (Fig. 6.6-5) can be developed. The realisation of the exact velocities can, for example, be carried out via utilisation of linear units in combination with DC servo motor and an integrated motion controller.



Figure 6.6-6: Towing-channel for the calibration and determination of the constants of a film sensor

Depending on the medium and area of utilisation, different styles of the sensors were developed. They differ with respect to their shape, dimensionality and temperature resistance and/or robustness. For liquid media, so-called film sensors (c.f. Fig. 6.6-7) are utilised which, in contrast to the hot wire, do not consist of a pure platinum or wolfram wire but rather feature a platinum-coated quartz cylinder. This quartz core makes the wire more robust against mechanical stresses.



Figure 6.6-7: Film sensor

6.6.2 Electrical Resistance Tomography (ERT)

Annett Lomtscher, Fraunhofer IKTS

Status	Development completed, ready to be used.
Type of substrate	Model substrates, biogenous substrates of any composition
Limitations of the method	For the operating principle of this measurement method, the substrates to be mixed must feature different conductivities
Advantages	Online measurement; no tracer(s) required; localized consideration of the mixing states; no spot measurement, but rather inclusion of the whole flow volume; taking into consideration of the real circumstances (granulometry, rheology); detection of dead zones, floating layers and settlings as well as badly mixed areas in the reactor
Need for research	Transfer of scale

The experimental evaluation of mixing processes in stirred systems becomes a challenging task, especially when opaque, fibrous and highly concentrated substrates (like digestion residues in biogas plants) are used. The analysis of mixing processes is locally limited by using measurement systems, like sensors, which are currently available on the market.

Electrical Resistance Tomography (ERT) enables a space-resolved consideration of the mixing process, as illustrated in Fig. 6.6-8. Areas with a high colour concentration in the reactor are presented as red coloured regions in the generated tomograms.

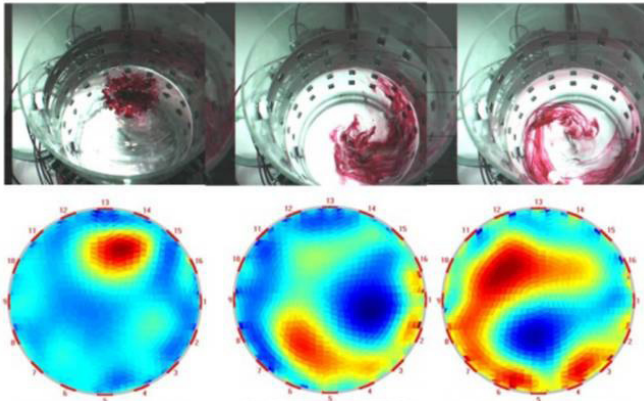

Figure 6.6-8: Visual comparison of the mixing of two liquids using ERT (Source: ITS 2012)

ERT can be used for online measurement and visualization of liquid-liquid, solid-liquid as well as liquid-gaseous systems. Further typical applications, in addition to the mixing processes, are crystallisation, filtration and separation processes, level detection on diffuse interfaces, multi-phase flows of oil, water and gases, as well as analyses regarding pneumatic conveying.

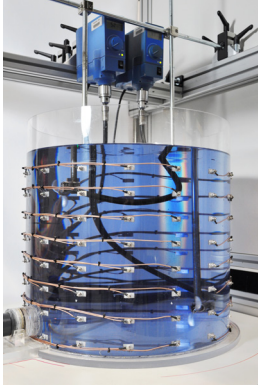

Figure 6.6-9: Process tomography (ITS System P2+) at Fraunhofer IKTS

With ERT a powerful technique is provided to allow a comprehensive and non-invasive quantification of mixing processes in biogas plants.

In addition to the evaluation of biogenous suspensions, virtually all types of complex suspensions can be analysed. Investigations in different scales are an essential prerequisite regarding the evaluation and optimization of large-scale mixing processes under consideration of similarity laws. Besides the true-to-scale replica of different reactor systems and the various installed stirring systems, the particles and fibers of the dispersed phase are also scaled. This is an indication for the high practical relevance of the work carried out at Fraunhofer IKTS.

The ERT system used at Fraunhofer IKTS (Fig. 6.6-9) is a commercial instrument (ITS P2+; Industrial Tomography Systems, Manchester, UK) and comprises a vessel with the sensor system consisting of an arrangement of several measurement electrodes grouped in planes, a Data Acquisition System (DAS) and a PC with control and data processing software. Fig. 6.6-10 presents the experimental setup for a cylindrical reactor.

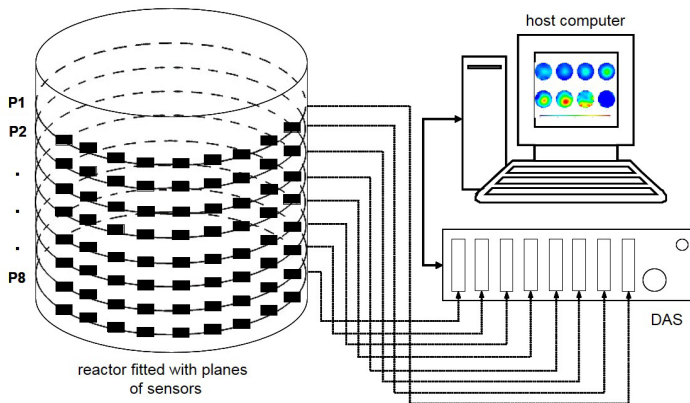

Figure 6.6-10: Components of the ERT system at Fraunhofer IKTS by means of the example of a cylindrical reactor with a height to diameter ratio of 1 and eight sensor planes.

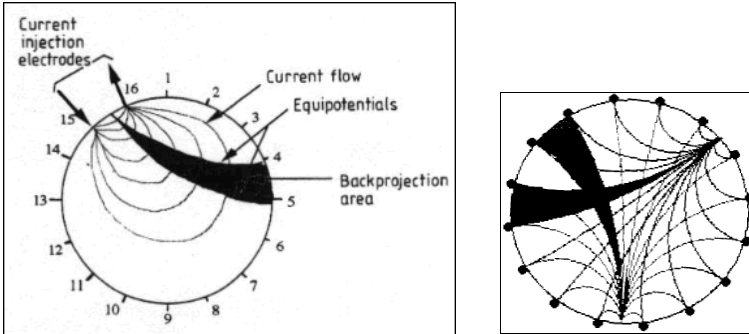

Figure 6.6-11: Measuring principle of the ERT system (Source: according to LEE 2009)

Each sensor plane consists of 16 electrodes, equally spaced around the periphery of the reactor. The number of sensing planes depends on the geometry of the mixing vessel. Pre-requisite for the evaluation of the mixing process with ERT are differences in the electrical conductivity between the continuous and the dispersed phase.

The adjacent measurement strategy, a pre-defined measurement protocol, is used to inject a defined current between every pair of electrodes in every sensor plane and measure the resultant voltage difference between the remaining pairs of electrodes, which are temporarily carrying no AC current. Thus, ERT produces a spatial cross-sectional potential field, (Fig. 6.6-11) which is influenced by the different electrical conductivities of the components of the multiphase system. As a result, the distributions of the electrical conductivities and the volume concentrations of the dispersed phase in the reactor can be determined.

The image reconstruction is realized by using the linear back projection algorithm (LBP). The advantage of LBP is its simplicity and low computational demand. To gather information about the internal conductivity distribution of the multiphase system, the reactor interior cross-section is spatially gridded into squares of equal size (pixels). Each sensor plane consists of such a two dimensional tomogram composed of 316 pixel. During the experiment, the electrical conductivities $\sigma_{P(x,y)}$ can be determined in accordance with Eq. 70 for every individual pixel in every sensor plane at any time.

$$\sigma_{P(x,y)} = \frac{\Delta \bar{\sigma}_{(x,y)}}{\sigma} = \frac{\sum_{m=1}^M \sum_{n=1}^N S_{m,n,x,y} \ln \left[\frac{V'_{(m,n)}}{V_{(m,n)}} \right]}{\sum_{m=1}^M \sum_{n=1}^N S_{m,n,x,y}}$$

70

$\sigma_{P(x,y)}$	Electrical conductivity of the pixel P(x,y)	mS cm ⁻¹
σ	Electrical conductivity	mS cm ⁻¹

$\Delta\bar{\sigma}_{(x,y)}$	Average partial conductivity change	mS cm^{-1}
m	Electrode pair to which the current is applied	[-]
n	Electrode pair at which the voltage is measured	[-]
$V_{(m,n)}$	Reference voltage measurement	mV
$V'_{(m,n)}$	Voltage measurement after indicating the conductivity change	mV
S	Sensitivity coefficient	[-]

For the determination of additional information regarding mixing and flow processes it is necessary, that the calculated pixel conductivities are converted into solid concentrations using Maxwell's equation (ITS 2009):

$$\Phi_{2i} = \frac{2\sigma_1 + \sigma_2 - 2\sigma_{mci} - \frac{\sigma_{mci}\sigma_2}{\sigma_1}}{\sigma_{mci} - \frac{\sigma_2}{\sigma_1}\sigma_{mci} + 2(\sigma_1 - \sigma_2)}$$

71

Φ_{2i}	Volume concentration of the dispersed phase in sensor plane i	%
σ_1	Electrical conductivity of the continuous phase	mS cm^{-1}
σ_2	Electrical conductivity of the dispersed phase	mS cm^{-1}
σ_{mci}	Electrical conductivity of the suspension (measured conductivity) in sensor plane i	mS cm^{-1}

The current state of the mixing process is displayed in two-dimensional tomograms or in three-dimensional illustrations (Fig. 6.6-12) along the reactor height respectively, which show the distribution of the dispersed phase inside the continuous phase. Sensor plane P1 indicates the upper plane and the sensor plane with the highest number represents the bottom plane in the selected reactor system.

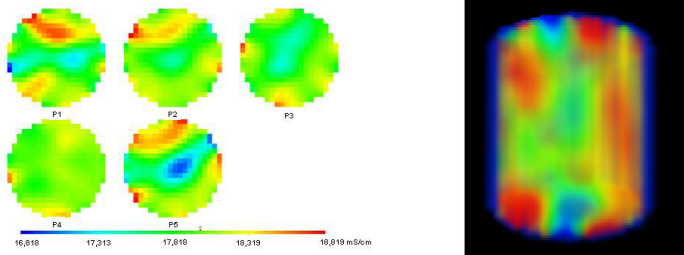

Figure 6.6-12: Visualization of the mixing process inside a cylindrical reactor with five planes of sensors: two-dimensional tomograms (to the left) and three-dimensional illustration of the reactor (to the right) (Source: IKTS)

The experimental investigations with ERT show that mixing processes in biogas reactors are significantly influenced by the substrate properties such as rheological behaviour and granulometric parameters, reactor geometry (Fig. 6.6-13) as well as mixing parameters like the selected stirring system.

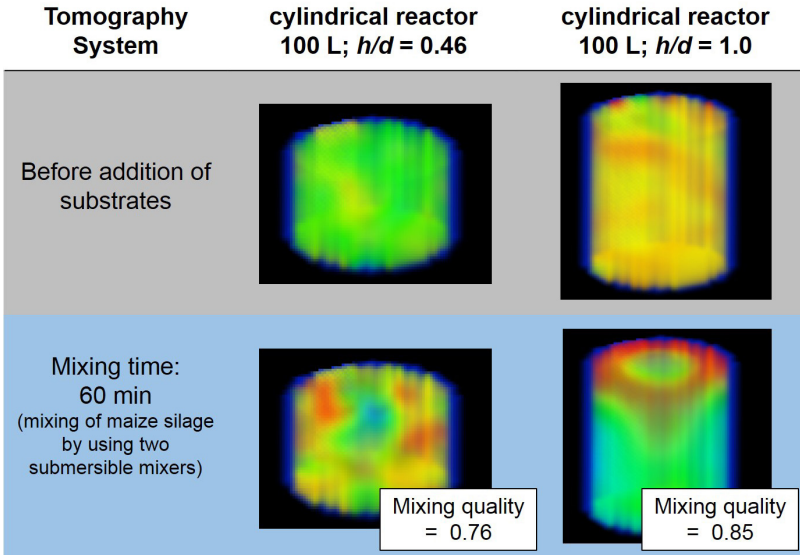

Figure 6.6-13: Average mixing quality in dependence on the reactor geometry (Source: IKTS)

Combined with advanced cross-correlation techniques, ERT offers the possibility to derive the axial flow velocity profile inside a stirred system. The analysis of the velocity profiles in the reactors is carried out with the commercial software AIMFlow, version 1.0 (MOSAIC Scientific Ltd., Leeds, UK). This software uses cross-correlation between two sensor planes to calculate the axial flow velocity. The determined conductivity maps are the initial source for the velocity calculation. The results are positive (= directed downwards) and negative (= directed upwards) flow velocities.

Fig. 6.6-14 shows the velocity profile of a suspension with fibrous particles (wheat straw) by using two submersible mixers.

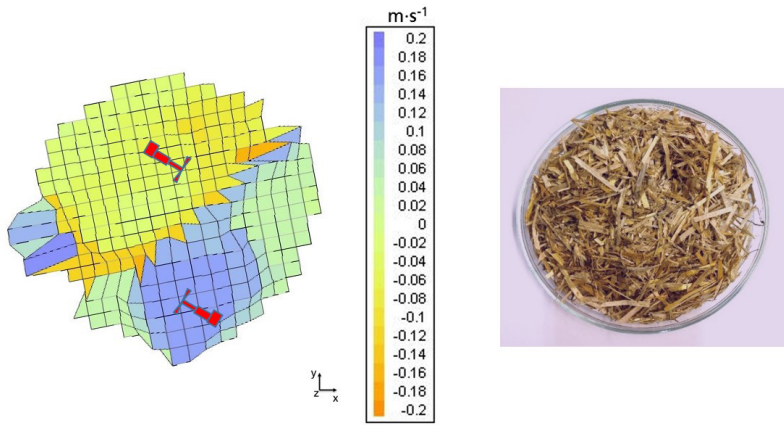

Figure 6.6-14: Velocity profile (to the left) of a suspension consist of xanthan gum and wheat straw (to the right) by using two submersible mixers (Source: IKTS)

6.7 Determination of the retention time by means of tracers

Helge Lorenz, Yong-Sung Kim, René Benndorf, Peter Fischer, DBFZ

Status	Development at laboratory and semi-industrial scale completed; ready to be used.
Associated standards	Biowaste Ordinance (BioAbfV 1998, as of April 23 2012), DIN CEN/TS 15290, DIN 38405, DIN 38414 S7, DIN EN 13650, DIN EN 13657, DIN EN ISO 17294-2
Type of substrate	<ul style="list-style-type: none"> Tracer <i>Bacillus atrophaeus</i> Suitable for substrates with fluid dynamic behaviour (e.g. fermentation substrate) under anaerobic or anti-germinating (e.g. seawater) conditions; Tracer lithium hydroxide Suitable for substrates with fluid dynamic behaviour (e.g. fermentation substrate)
Limitations of the method	<ul style="list-style-type: none"> Tracer <i>Bacillus atrophaeus</i> Detection limit in fermentation substrate at approx. 103 spores/g Tracer lithium hydroxide Low natural background level of the substrate must be taken into account; dosage at least 50 mg Li/kg TS fermentation substrate
Advantages	<ul style="list-style-type: none"> Tracer <i>Bacillus atrophaeus</i> Advantages of the bacteria spores: High thermal resistance and tenacity, no background concentration in fermentation substrate, epidemiologically safe, biological/ecological tracer Tracer lithium hydroxide Detection by means of elementary analysis, high stability, chemically inert
Need for research	Implementation of tracer analyses at industrial-scale

The retention time has a strong impact on the efficiency of the decomposition processes and is essential to hygienisation. The average retention time is of interest for the process-kinetic evaluation; however, the minimum guaranteed retention time (MGRT) is of greater importance for the hygienisation.

The definition of the MGRT in accordance with the Biowaste Ordinance BioAbfV (1998): "... is the period of time that was determined up to the last sample without findings prior to the first-time detection of the tracer."

The theoretical average retention time of the fermentation substrate in the digester is expressed by the technical or hydraulic retention time (HRT); it is the period of time that

a substrate particle remains, on average, in the digester until it is removed. The HRT is a theoretical parameter and serves as basis for describing the real process.

In the case of constant volume-processes, the hydraulic retention time is calculated from the ratio of the useable reactor volume (m^3) to the daily amount of substrate fed (m^3/d):

$$\text{HRT} = V_R / \dot{V}_{\text{fed}}$$

72

HRT	Hydraulic retention time	d
V_R	Reactor volume	m^3
\dot{V}_{fed}	Amount of substrate fed	$\text{m}^3 \text{d}^{-1}$

Reactors that have a defined mixing behaviour can be regarded as ideal reactors. In the biogas sector, two types of reactors are of importance with respect to the continuously operated digesters: the fully-mixed “stirred tank reactor” and the “plug-flow reactor”. In process engineering, these two types are described by idealised assumptions, which will not occur during normal operation. In a real reactor, some individual substrate particles are discharged sooner and others later. Retention time density function, and the retention time sum function are determined from retention time tests. Extrapolating from these allows the real average retention time to be calculated.

The equivalent number of stirred tank reactors calculated from the moments of the retention time distribution is decisive for the mixing of the digester. A „stirred tank“ is indicative that a digester is ideally and completely mixed (minimum retention time theoretically = 0). In the case of an infinite number of stirred tanks, an ideal plug-flow exists. If the real average retention time is below the hydraulic retention time, dead zones exist inside the digester. Dead zones are either poorly mixed or not mixed at all. Such dead zones reduce the real volume of the digester, which causes a shorter retention of the particles. A short-circuit flow exists when large amounts of the substrate are discharged before the calculated hydraulic retention time. This means there is a direct flow from the inlet to the outlet; thereby, the real average retention time is greatly reduced. Dead zones and short-circuit flows are undesirable since they reduce the average retention time and thus – among other things – the biogas yield.

In the case of a continuous reactor feeding, the MGRT defined in the Biowaste Ordinance (BioAbwV 1998) can also be significantly shorter than the calculated hydraulic retention time due to short-circuit flows. Furthermore, the retention time distribution differs for particles of different size.

If partial fractions of the wastes remain in the reactor only for a short period, the epidemiological and phytohygienic aspects are problematic, and the fermentation substrate digestion is also incomplete. Insufficiently sanitised digestates are considered as a vector for the spreading of pathogenic germs. Therefore, knowledge of the MGRT of the substrate particles in the digestion tank is essential for the assessment of the hygienisation.

In accordance with the Biowaste Ordinance (BioAbfV 1998), in biogas plants which use biowaste as fermentation substrate, the waste matrix must be treated in such a way "that over the contiguous period of the MGRT the treatment temperature is affecting the whole material in the thermophile range (at least 50 °C)." If these conditions cannot be kept, an alternative hygienisation of the digestates is necessary.

Analyses with tracers (markers, indicators) are suitable for the determination of the minimum retention time of substrate particles in the digestion tank. According to the Biowaste Ordinance BioAbfV (1998), the time span determined from the tracer analysis represents the shortest retention time in the digester for all substrate components (solid and liquid). For this, substrate is marked with a tracer and subsequently the time span from the input until the first detection of the tracer in the outflow is recorded.

Different materials can be used as tracers. In particular, the tracer material must be stable, chemically inert, and have the same fluid-dynamic behaviour as the substrate particles.

It is known that the mixing state of a reactor affects the quality of the fermentation process greatly. Analysing the retention time behaviour is important to carry out in order to test the quality of the process. Comparative tests with different tracers help to characterise the retention time behaviour of real reactors. Weak points in the reactor such as zones that are not or only insufficiently mixed (stagnation zones, dead zones), short-circuit flows, and floating covers (setting and floating layers) can be identified by a combination of experimental retention time tests by means of tracer and tools of CFD (computational fluid dynamics). Depending in which way the tracer is inserted into the reactor (as impulse function [Dirac-pulse: one-time addition of tracer at $t = 0$] or as jump function [addition of tracer continuously from $t = 0$ on]), the retention time density function $E(t)$ or the retention time sum function $F(t)$ can be determined.

The marking substances for the experimental determination of the functions $E(t)$ and $F(t)$ should feature the following characteristics:

- Viscosity and density of the tracer must correspond to those of the reaction mass or to the reactor content (chemically inert, no impact on the physical properties of the reaction mass, no adsorption onto reactor parts, easily detectable also in very low concentrations).
- Addition of tracer should be carried out isokinetically so that the flow state is maintained.
- Diffusion coefficient of the tracer should be as low as possible.

Tracer analysis with bacterial spores for the determination of the minimum guaranteed retention time

With the aerobic endospore former *Bacillus atropheus* (synonym *B. globigii* DSM 675), a microorganism is available that can already be used as a bioindicator in various ways due to the specific tenacity of its spores.

In biogas plants, the bacterial spores (approx. 1 to 2 μm in size, Fig. 6.6-15) mix very well with the fermentation substrate. In batch tests under anaerobic conditions it was shown



Figure 6.6-15: Vegetative cells, endospores and spores of *Bacillus atrophaeus* (1,000 x) (LTR) (Source: DBFZ)

that spores were not decomposed over a retention time of at least 37 days (DBFZ study). The spores of the ecologically harmless bacterium are inert in the anaerobic digester. Additional advantages of the bacteria spores are their high thermal resistance, their lack of natural occurrence in the fermentation substrate (no background concentration in the digester), their quality of biological material as well as their epidemiological harmlessness (non-pathogenic). The microorganism can be detected quickly and reliably in the laboratory.

For the analyses with this tracer it is important to know the spore concentration in the initial suspension as well as the detection limit of *Bacillus atrophaeus* in environmental samples (fermentation substrate). The spore concentration mentioned in the revised version of the Biowaste Ordinance (10^6 spores mL^{-1} of fermentation substrate) is quantitatively difficult to set in industrial-scale facilities. Therefore, the detection method should be improved to such an extent that even lower spore concentrations (10^3 to 10^4 spores mL^{-1}) can be detected in environmental samples.

Spore production on surface method (solid state fermentation)

The medium for the preculture is a tryptone glucose broth (TGB). TGB can be inoculated with a non-specific amount of a *Bacillus atrophaeus* sample (e.g. DSM stock culture¹, spore suspension).

It is incubated in an incubator shaker at 37 °C and 120 rpm over night (22 ± 2 h) in order to obtain a culture in the exponential growth level.

Under a sterile bench conditions, approx. 2 to 5 mL of the TGB culture are transferred with a sterile glass pipette to a Petri dish with yeast extract agar (MYA) and tilted several times until the surface of the agar is completely covered with the inoculum. Excess inoculum is removed and can be transferred to the next plate. The Petri dish is incubated at 30 ± 1 °C.



Figure 6.6-16: Spore powder of *Bacillus atrophaeus* as final product (Source: DBFZ)

¹Bacillus atrophaeus (DSM No. 675 Bacillus atrophaeus Nakamura 1989), Deutsche Stammsammlung für Mikroorganismen und Zellkulturen GmbH [German Collection of Microorganisms and Cell Cultures] (DSMZ Sales, Inhoffenstraße 7 B, D-38124 Braunschweig)

After three to five days of incubation, the state of the culture is assessed under the microscope. The incubation is continued until the maximum sporulation rate is reached and the inoculated vegetative cells are autolysed (eight to ten days).

Under sterile bench conditions, the bacteria spores are removed by means of a sterile glass spatula and suspended in water (washed with approx. 10 mL aqua_{dist.}). The supernatant is drawn off by a glass pipette and collected in Schott bottles.

Approx. 50 mL of spore suspension is placed in centrifuge tubes (tare out samples by means of aqua_{dist.}). Four consecutive rinsing steps are carried out by centrifugation (each time pipetting off the supernatant carefully, refilling with aqua_{dist.} and centrifuging 20 min, 4 °C, 7,000 rpm). Subsequent to the last step, pipette off again and suspend in aqua_{dist.}. The suspension (approx. 100 mL) is transferred into a 500 mL Schott bottle with screw cap and heated for 15 min at 80 ± 1 °C in a water bath in order to kill vegetative cells. The concentration of the *Bacillus atrophaeus* spore suspension should be approx. 10^9 spores mL⁻¹ and can be stored in a refrigerator for approx. one year at 4 °C.

Spore staining for sporulation control

An air-dried heat-fixated preparation of the bacteria culture is made. Firstly, the sample on the microscope slide is heat-fixated at 90 °C until complete drying. By addition of a 5% aqueous malachite green solution, the preparation is stained for 1 min at 80 °C. After washing, a 3% aqueous safranin solution is added and counterstained for approx. 1 min at room temperature. The preparation is checked under a microscope at a thousandfold magnification.

Result of the staining

Spores	Turquoise
Bacteria cell	Red
Cell residue	Diffuse red matrix

Application of spores as tracer

Immediately prior to the addition of the biotracers, at least two single samples are collected at the digester outflow as negative control.

For the determination of the retention time, the biological tracer is mixed homogeneously with the fresh fermentation substrate and added once into the reactor as impulse function (Dirac-pulse). The amount of the spores mixed with fermentation substrate is to calculate in such way, that a certain spore concentration per gram (and/or mL) of digester content can be set (e.g. 10^4 spores mL⁻¹ of fermentation substrate). To do this, it is necessary that the spore concentration of the spore powder or spore suspension must be determined in advance. A control of the adjusted concentration of *Bacillus atrophaeus* spores in the feeding charge must be carried out.

After feeding of the marked fermentation substrate in industrial-scale biogas plants, the sampling (single sample of at least 20 g) is carried out in the outflow until the tracer is for the first time detectable in a sample, and – in particular – at least:

- immediately or 5 min after the addition of the spores in the case of continuous mode of operation,
- each hour, until and including the 24th hour,
- thereafter every 2 hours, until and including the 36th hour,
- thereafter every 4 hours, until and including the 48th hour,
- thereafter every six hours.

Detection of the spores

For a predilution, 20 g from each sample (approx. 20 mL g⁻¹ of sample) are weighed into 180 mL sodium chloride solution (0.9% saline solution) and mixed for approx. 20 hours at 4 °C on the shaker (150 rpm).

After homogenisation, 1 mL of each sample is pipetted in geometric series up to dilution level 10⁻⁸ in respectively 9 mL NaCl solution, and mixed.

Thereafter, respectively 0.1 mL of each dilution level (starting with 10⁻⁸) is pipetted and evenly spread on two parallel standard I nutrient agar plates using a sterile glass rod or Drigalski spatula (incubation at 37 °C for 22 ± 2 h).

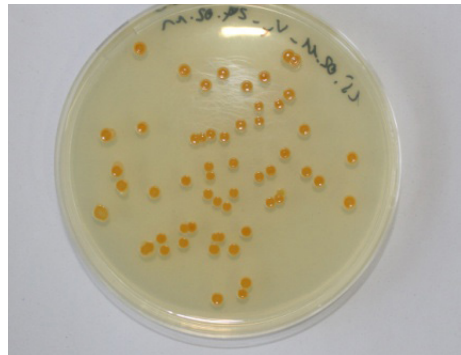

Figure 6.6-17: Detection of *Bacillus atrophaeus* in surface method on standard I nutrient agar (Source: DBFZ)

The suspension and the dilution stages can be stored at 4 °C.

Only such colonies are counted on the agar plates which show a typical orange growth (Fig. 6.6-17).

Calculation of the bacteria concentration on agar plates (CFU mL⁻¹):

$$\text{CFU per mL} = \frac{\sum c}{\sum_{i=1}^{\infty} 10^{-i+1} \cdot n_i} \cdot F_a \cdot F_b \cdot F_c$$

73

CFU Colony-forming units

c Sum of the CFU counted on the plates

n Number of plates of each counted dilution level, starting with the lowest level (n₁)

F_a Factor of the first counted dilution level

F_b Factor of the predilution

F_c Multiplication factor of the application volume of 0.1 mL relative to 1 mL

Tracer analysis with lithium for the determination of the minimum retention time

The suitability of a lithium compound (lithium hydroxide monohydrate $[\text{LiOH} \times \text{H}_2\text{O}]$) as tracer has been proven by a DBFZ study. The substance has similar dynamics in the digester as the fermentation substrate and does not react with it. Lithium is elementarily simple to analyse and can be precisely detected.

While determining the lithium in the digestate, a low natural background level of the substrate must be taken into account. The lithium background level must be determined before the analysis. For this, samples are drawn at the digester outflow at least 5 days prior. In a fermentation substrate (digestate, maize silage), the background level was determined to approx. 0.25 to $0.30 \text{ mg Li kg}^{-1}$ total solids (TS). Depending on the type of the fermentation substrate, the lithium background concentration can be up to $5 \text{ mg per kg TS}^{-1}$.

Application of lithium as tracer

For the determination of the retention time, the dissolved chemical tracer is mixed homogeneously with the fermentation substrate and added once into the reactor as impulse function (Dirac-pulse). The amount of the lithium tracer mixed with fermentation substrate should be calculated, that a specific concentration per kilogram of digester content can be set (at least 50 mg Li kg^{-1} TS fermentation substrate). The amount and application of the lithium tracer depends on the amount of the reactor as well as on the amount of solids of the fermentation substrate.

After the feeding of the marked fermentation substrate in industrial-scale biogas plants, the sampling (single sample of at least 50 g) is carried out in the outflow until the tracer is first detected above the background concentration in a sample, and – in particular – at least:

- immediately or 5 min after the addition of the lithium in the case of continuous mode of operation,
- each hour, until and including the 24^{th} hour,
- thereafter every 2 hours , until and including the 36^{th} hour,
- thereafter every 4 hours , until and including the 48^{th} hour,
- thereafter every 6 hours .

Detection of the lithium

The chemical decomposition of the samples is made by means of aqua regia, and the analysis by means of inductively coupled plasma optical emission spectrometry (ICP-OES) (detections are carried out in accordance with DIN CEN/TS 15290, DIN 38405, DIN 38414 S7, DIN EN 13650, DIN EN 13657, DIN EN ISO 17294-2). A concentration value in mg Li kg^{-1} TS is determined.

6.8 Determination of the retention time behaviour with the help of studies of tracers

Anne Kleyböcker, GFZ

Status	Tracer studies contribute to the detection of shortcircuits, stagnation zones and dead zones in biogas digesters. These affect the biogas production process and lead to economic losses. The addition of uranine as tracer has already been established for various substrates (sewage sludge, biowastes).
Associated standards	In addition to uranine, sodium fluoride, lithium chloride and radioactive isotopes are also utilised as tracers.
Area of application of the method	The tracer uranine can be used for various substrate combinations.
Need for research	The use of uranine as tracer is cost-efficient and can be applied to various substrates. Nevertheless it is necessary to test the tracer for substrates with a high turbidity, and to determine the limits of detection.

General

The retention time in a digester operated as a continuously stirred tank reactor must be guided primarily by the generation time of the microorganisms. If the retention time is shorter than one generation time, the microorganisms are washed out and the process of the biogas production can no longer take place completely. In this context, the type of digester is of importance. If the biomass remains longer in the reactor (e.g. in a fixed bed reactor) than the liquid phase, other guidelines apply.

The retention time behaviour strongly depends on the mixing, which is influenced by the mixing system, the reactor geometry, and the inflow and discharge rates. The better an agitated reactor is mixed, the better the substrate is distributed in the reactor and the lower the discharge of non-fermented material will be. First and foremost, shortcircuits, stagnation zones and dead zones should be avoided and, best case, the formation of a floating sludge layer and formation of foam should be fought (JANKE 2008). For ecological and economic reasons, the energy demand for the mixing should be kept as low as possible.

The retention time distribution can be determined with the help of a tracer that can be introduced into the reactor as a shock load and whose concentration in the discharge is measured in dependence on the time (DANCKWERTS 1953). For the interpretation of the results, standardised concentrations are suitable in order to be able to better compare the results with others (LEVENSPIEL 1962). To date, tracer studies in biogas reactors have primarily been carried out with sodium fluoride, lithium chloride and radioactive isotopes (ANDERSON et al. 1991; BORROTO et al. 2003; HEERTJES et al. 1982; MONTEITH & STEPHENSON 1981; TENNEY & BUDZIN 1972; WHITE 1974).

Not only can the average retention time \bar{t} – which in the case of continuously stirred tank reactor (CSTR) corresponds to the calculatory hydraulic retention time – be determined via the retention time distribution, but shortcircuits and stagnation zones can also be detected this way. The calculatory hydraulic retention time (HRT) is calculated by dividing the volume of the digester with the volume flow rate of the substrate in accordance with Eq. 74 (JANKE 2008).

$$\text{HRT} = \frac{V_{\text{reactor}}}{\dot{V}} \quad 74$$

The average retention time \bar{t} is determined with Eq. 71 via the distribution sum function $F(t)$ (Eq. 72, (KRAUME 2004)), wherein the distribution sum function is the integral of the distribution density function $E(t)$.

$$\bar{t} = \int (1 - F(t)) dt \quad 75$$

$$F(t) = \int E(t) dt \quad 76$$

According to (KRAUME 2004), the distribution density function for an ideally stirred tank for $n = 1$ and for a cascade of ideally stirred tanks with $n = 2$ stirred tanks is calculated in accordance with Eq. 73. In this, it is assumed that each stirred tank is ideally mixed and that no return transport of material into a tank back is possible.

$$E(t) = ne^{(-nt)} \frac{(nt)^{n-1}}{(n-1)!} \quad 77$$

State of development/area of application of the uranine tracer

Suitable as chemical tracer is in addition to sodium fluoride, lithium chloride and radioactive isotopes also uranine ($\text{Na}_2\text{C}_{20}\text{H}_{10}\text{O}_9$), a fluorescing dye. According to KÄSS (2004), uranine is not degradable in severely organically contaminated groundwaters and sewage sludges and is also not adsorbed. In-house laboratory measurements confirmed these claims and showed that uranine is also suitable for biogas plants. The limit of detection of uranine depends on the substrate utilised and can under the most favourable conditions be in a range below $0.002 \mu\text{g L}$.

One advantage of this method is that uranine is more cost-efficient in comparison to other tracers since uranine can be detected already in low concentrations and therefore very small quantities are sufficient for a tracer study. Moreover, it can be fed to the reactor without any great expenditure because of that. For analyses in biogas reactors that are operated with sewage sludge and biowastes, 1 kg of uranine per $1,000 \text{ m}^3$ of digester volume is sufficient, for example. Since only a fibre optic fluorimeter is needed for the determination of the uranine concentration, the determination of the concentration is also cost-efficient.

Description of method

Sample preparation/materials/devices

In order to determine the optimal amount of uranine for a tracer study, it is recommended to prepare a calibration series with corresponding uranine amounts in digestate from the digester to be analysed. In this, it must be ensured that a correspondingly large range of concentrations is covered so that even after multiple hydraulic retention times uranine can still be detected. If the uranine concentrations are proportional to the fluorescence, this indicates the suitability of the uranine for the digestate in question. In untreated sludge, uranine cannot be measured undisturbed. Therefore, the fermentation sludge sample is centrifuged twice at 10,000 rpm for 10 min, each. In between the centrifuging processes, the samples are decanted. Subsequently, the sample is checked – under the exclusion of light – for its fluorescence, using a fibre optic fluorimeter of the Hermes company with a fibre optic sensor.

Carrying out a tracer study

The tracer is introduced into the industrial scale biogas reactors as a shock load. To detect any shortcircuits, it is important to determine within short time intervals the tracer concentration in the digestate directly after the addition of the tracer. Since stagnation zones frequently occur in digesters, the tracer study should cover at least six hydraulic retention times.

Analysis of the results/data

The concentration graph of the tracer in dependence on the time represents the distribution density function. The integral of the distribution density function results in the distribution sum function (c.f. Section "General").

The average retention time can be calculated from the distribution sum function in accordance with Eq. 75. The determination of the retention time behaviour is carried out based on the assessment of the distribution density function. In this, the measured values are mapped with the help of models (ideal stirred tank, cascade of ideal stirred tanks, paralleling of ideal stirred tanks, flow tube, and their combinations). The models provide estimates regarding stagnation zones and shortcircuits.

6.9 Process specification for the determination of sand

Katrin Strach, DBFZ

Status	To date, the method has been utilised for the determination of the particle size distribution of mineral shares in low-fibre agricultural residues, digestates and biowaste. It was evaluated with sand-free reference biowaste and quartz sand. (KRANERT et al. 2002b)
Associated standards	Determination of the particle size distribution of bulk materials in accordance with DIN 66165
Area of application of the method	Digestates, liquid manure, solid dung, dry chicken faeces and biowaste.
Limitations of the method	The method has not yet been utilised for materials with a high fibre content and materials that tend to agglomerate. For wet screening, the bottom limit of usability was determined at a 5% sand share, an upper limit has not been defined. (KRANERT et al. 2002a, 2002b)
Advantages	It is a simple, easy to handle and environmentally friendly method. The particle size distribution can be utilised as basis for the assessment of the damage and settling processes to be expected.
Disadvantages	The approach is time-consuming.
Need for research	The method should be tested with additional substrates and digestates in order to determine its limits.

The screen analysis is a method for the determination of the particle size distribution of bulk materials and is described by DIN 66165. In this, the most common and easiest method for the analyses is the dry screening. But if a substrate is used that tends to agglomerate, wet screening provides for more accurate results. In the case of wet screening, the quantification of the particle sizes is realised with the help of the medium water via a set of screens.

The individual fractions are present in a mixture of organic and mineral components and can subsequently be "separated" calculatorily via the determination of the loss on ignition. What remains is the whole mineral component which is stated as mass per cent of total solids. Modelled after soil science, the mineral components are categorised in accordance with DIN ISO 11277 in dependence on the particle size as follows:

Table 6.9-1: Categorisation of mineral components exclusive of soluble salts in dependence on the particle size

Mineral component	Particle size [μm]
Gravel	63,000–2,000
Sand	2,000–63
Silt	63–2.0
Clay	2.0–0.2

In accordance with the definition in Tab. 6.9-1, for the determination of the inert components in substrates, up to seven analysis screens of 63 to 2,000 μm are utilised and placed in a screening tower wherein each consists of a screening frame and a sieve plate with different mesh width. The screening frequency can be adjusted at the control knob of the machine.

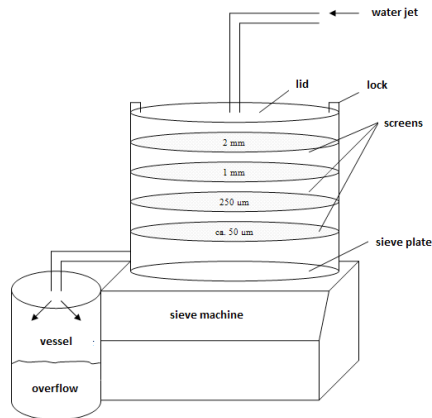

Figure 6.9-1: Setup of sieve machine (Source: SCHNEIDER 2010)

Wet screening

In wet screening, the material to be tested is transferred into a suspension with water prior to the screening process, homogenised and subsequently placed on the top screen. With the help of a water spray jet, the screen sample can be rinsed through the individual analysis screens. In this, the volume flow must be selected such that the whole screen area is wetted. Furthermore, the optimal frequency of the shaker facility at maximum water throughput can be controlled and set at the overflow. The rinsing and screening is carried out until the suspension carried off below the screening tower is visually clear and does not feature any turbidity.

Subsequent to the screening, the whole stack of screens is initially dried for 24 h at 105 ± 5 °C in a drying cabinet, weighed-in and only then through careful beating out of the screens transferred into individual beakers. After the calcination of the samples, the organic components can be determined through weighing and the inert shares can be calculated in accordance with Eqs. 78 and 79. The suspension of the overflow is caught in a separate vessel and weighed. The inert components are determined analogously on a partial sample.

Dry screening

In the dry screening, the sample to be analysed is first placed for 24 h in a drying cabinet at 105 ± 5 °C and subsequently calcined in a muffle furnace at 550 ± 5 °C for 3.5 h. The previously carried-out drying has the utmost priority since with the immediate calcination of the wet sample. Very high temperature can be generated due to the instantaneous evaporation of the water. This can lead to puffing out, encrusting of the sample or even up to the destruction of the crucible. Furthermore, an even distribution of the sample in the crucible must be ensured in order to ensure a complete drying through and calcination of the sample. After the screened material has cooled down, the sample is weighed, homogenised, subsequently introduced to the topmost analysis screen and screened with a suitable frequency for different periods of time. The residues from the individual test screens are subsequently transferred into a beaker by carefully beating out and brushing off the screens and determining the particle size distribution through weighing. This way, the particle size distribution of the mineral share is determined directly; the organic fraction can only be assessed as a sum.

Result calculation

In order to calculate the mineral share of a fraction, the mass of the inorganic share is considered in relation to the mass of the total solids. The impurities of the inorganic share due to organic components are calculatorily adjusted with a reference value of 0.9–0.95. This value depends on the type of the organic material. Here, a representative, mineral-free partial sample should be taken from the sample for determination and calcination.



Figure 6.9-2: Overflow in the case of completed wet screening (Source: SCHNEIDER 2010)

$$S_{TS} = \frac{m_{ioTS} - (1 - \text{Ref}) \cdot m_{VS}}{m_{TS}} \quad 78$$

S_{TS}	Pure mineral share relative to the total solids	% _{TS}
m_{ioTS}	Mass of inorganic total solids after calcination	g
m_{VS}	Mass of volatile solids before calcination	g
m_{TS}	Mass of the total solids	g
Ref	Loss on ignition of the organic share; figure drawn from past experience: 0.9–0.95	g

If the specification of the total share of mineral substances is desired, the summation of the individual fractions is carried-out:

$$S_{TS \text{ tot}} = \sum_1^n S_{TS} \quad 79$$

S_{TS}	Sand share of the individual fractions	%
$S_{TS \text{ tot}}$	Total sand share	%

A sample presentation of results is depicted in Fig. 6.9-3. The substrate and various samples from a digester for biogas production were inspected for mineral components. (LIEBETRAU et al. 2011)

The Fig. shows the shares of the fractions in the overall mineral share of the samples. It is apparent, for example, that all samples inspected have an increased share of clay and silt.

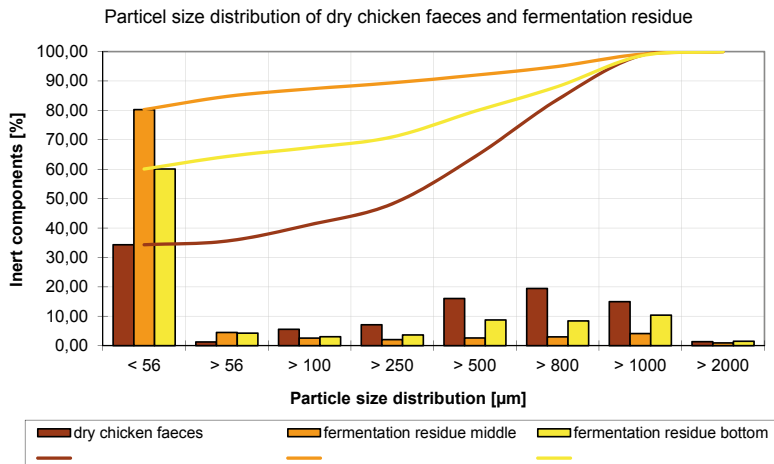

Figure 6.9-3: Depiction of results of sand determination (SOURCE: SCHNEIDER 2010)

Comparison of the methods

With both screening methods, recovery rates of more than 99% can be achieved. Due to the easier handling of the dry screening, the error is smaller.

Both methods provide qualitatively very good and comparable results. Starting at a particle size of 500 μm , it was possible to achieve quantitatively comparable measuring results independent of the test duration, while with an increase of the screening duration to 30 min, an approximation of the results could already be observed at 250 μm . The reason for this is the dropping flow rate with decreasing particle size due to the analysis screens. The method of dry screening is therefore suitable for the determination of the inert share with a corresponding time investment, for the quantification of individual shares up to 100 μm .

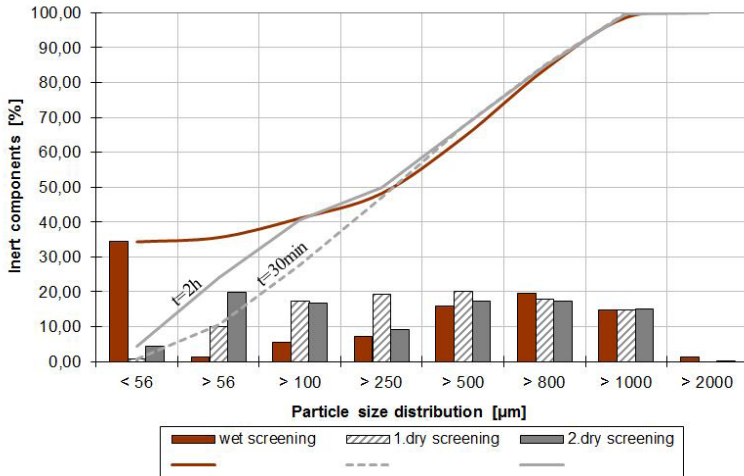

Figure 6.9-4: Comparison of the screening methods (Source: SCHNEIDER 2010)

7 Methods for the determination of biological parameters

7.1 Description of the experiment for the Oberhausen/Rostock/Göttingen Activity Test (ORGA-Test)

Nils Engler, DBFZ

Status	The method has been and/or is being applied as part of various research projects. The possibility of its application in full-scale plant operations does not presently exist but is currently the topic of research.
Associated standard	None
Area of application of the method	<ul style="list-style-type: none"> ● Inspection of digester content for performance of the digester biology ● Detection of inhibiting effects of substrates or contents on the anaerobic degradation process
Disadvantages	<ul style="list-style-type: none"> ● Test measuring time (approx. 7 d) ● Measurement of the composition of the biogas generated is not possible
Advantages	High temporal resolution of the measurement, thereby allows for a detailed inspection of individual decomposition phases.
Need for research	In the case of application as inhibiting substance test: Derivation of actual utilisation limit values of the inhibiting substances for practice.

The method described below was developed with the University of Applied Sciences in Göttingen, Department: NEUTec, and the University of Rostock, Department of Waste and Material Flow Management, as part of a joint research project funded by the AIF under the direction of the Fraunhofer Institute for Environmental, Safety, and Energy Technology UMSICHT. Based on the locations of the three project partners, the method was named Oberhausen/Rostock/Göttinger Activity Test, in short ORGA Test.

The ORGA Test is intended to allow for a comparative quantification of the biological activity of renewable resources biogas digesters. This is realised via a measurement with high temporal resolution of the substrate conversion of a standardised substrate under standardised boundary conditions. From the kinetics of the conversion of a standard substrate, far more differentiated information regarding the condition of the digester biology can be derived than from the biogas potential alone, the way it is determined in classic batch tests. Furthermore, the information is available to the plant operator significantly faster due to the comparatively short test period of 5–7 d.

The instrumental basis for the test method is formed by the *Gas Production System* of the ANKOM company. The method is based on the measurement of the increase in pressure in a constant volume at constant temperature.

Depending on the issue at hand, different standard substrates that have to fulfil the following requirements can be used for the ORGA test:

- Reproducibility: Known and describable composition
- Quantifiability of the results: Known biogas yield
- No impact on the objective of the inspection: Itself free from promoters/inhibitors
- Decomposability: The composition of the essential nutrients corresponds approximately to the substrate of renewable resources biogas plants at concomitant virtually complete decomposability

The ORGA test can be carried out with the following standardised substrates:

- Acetate (acetic acid) is directly available for the methane-producing microorganisms. From the kinetics of the acetate conversion, conclusions regarding the performed especially of the methanogenic phase are possible.
- Maize starch as quickly decomposable substrate for hydrolysing and acid-building microorganisms. It was possible to prove that in the case of utilisation of pure maize starch the individual phases of the methane formation take place temporally one after the other. This makes an analysis of the whole reaction chain of methane fermentations possible, especially the transition from the acidification to the methane building phase.
- As synthetic complex substrate, a mixture made of micro-crystalline cellulose, maize starch, glucose as well as phosphate buffer and urea is utilised, wherein the formulation is adjusted such that the C:N:P ratio approximately corresponds to that of a maize silage. Therewith, a complex, yet long-term reproducible standard substrate is available.

Execution of the test

For the activity test, fermentation vessels with a working volume of 500 mL are utilised. The weighed-in sample quantity is approx. 15 g_{vs}, which corresponds to approx. 200–400 g of digester sample. In order to ensure the stirrability by means of a magnetic stirrer, dilute with clean water, where necessary. Of each digester sample to be analysed, blank test, control (digester sample with standard substrate) and, where applicable, different treatment variations (enzymes, trace elements etc.) are each analysed in at least triplicates. The fermentation vessels are heated in the water bath at 38 °C. The temporal resolution of the measured values is 30 min, wherein in terms of the system temporal resolutions in the range of seconds are possible.

The fermentation vessels are mixed through once a day by means of magnetic stirrer. The gas yield is calculated taking into consideration the accompanying blank tests based on kg_{VS} of the substrate used. For the presentation of result, the cumulated gas volume is put in relation to the theoretical maximum biogas yield of the standard substrate according to (BUSWELL 1952) and presented as standardised time curve. This way, significantly more information can be obtained in comparison to other methods such as the determination of the biogas potential in the batch test. Additionally, due to the utilisation of selective substrates, a separate analysis and assessment of the individual phases of methane production is possible.

The following criteria serve for quantification of the decomposition performance of the digester biology, and for comparison of different digester samples:

- Acetic acid and synth. complex substrate: t_{50} as the time that is needed to generate approx. 50% of the theoretical biogas yield.
- Maize silage: Here, two time criteria, t_{40} and t_{60} , are utilised which each are required to generate approx. 40% and/or 60% of the theoretical biogas yield. Additionally, from the increases s_1 (of the hydrolysis) and s_2 (of the acetogenesis/methane production, each in $[\text{mL}/\text{g}_{\text{VS}} \cdot \text{d}]$) of the cumulative gas graph, information regarding the condition of the digester biology can be obtained.

Depicted in Fig. 7.1-1 is a characteristic gas production curve, each for the two substrates acetic acid and maize starch as well as the situation of the assessment criteria.

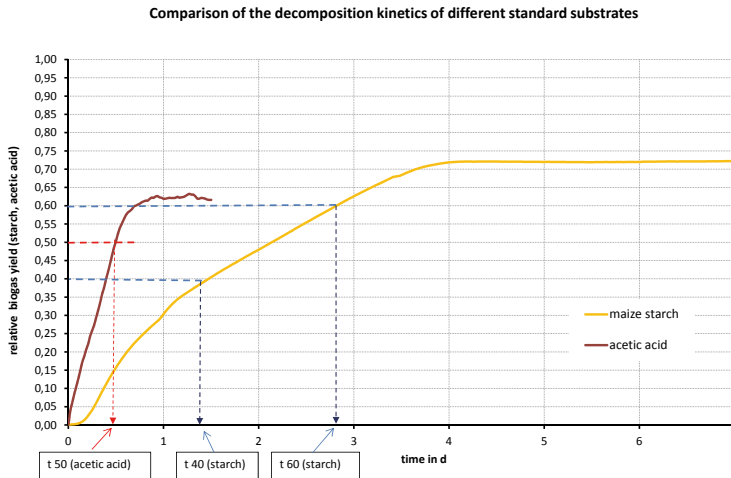

Figure 7.1-1: Typical decomposition kinetics of the standard substrates maize starch and acetic acid and assessment criteria (Source: University of Rostock)

State of development and application

The ORGA Test (ENGLER et al. 2011) is not yet an established method. The objective of the research project was to develop the test methodology and to utilise it for the optimisation of the trace element supply of renewable resources biogas plants.

The method development has been completed and since 2010 the test has been utilised at three participating research sites in accordance with standardised process specifications. As part of the project, samples were taken from approx. 40 biogas plants in Mecklenburg-Western Pomerania, Lower Saxony and North Rhine-Westphalia and analysed with the ORGA Test. Parallel to this, comprehensive analysis of the digester samples were carried out with a particular focus on macro nutrients and trace elements. The results are fed into tests regarding the optimisation of industrial-scale plants. In the IVth quarter of 2011, a large scale test, each, was planned at a industrial-scale plant at each participating research site.

In a modified form, the ORGA Test is also intended to be used for the detection of potential process inhibitors. Preliminary work regarding this has been already conducted.

7.2 Nucleic acid based molecular biology tests

Denny Popp, Fabian Bonk, Daniela Becker, Sabine Kleinstüber, UFZ

Status	The described methods are well established for research purposes. All instruments and reagents are commercially available.
Standard	There are no official standards. However, there are best practice instructions for the methods. Protocols have to be adjusted to the specific samples, especially the nucleic acid extraction method.
Area of application	Nucleic acid based molecular biology tools are applicable to any biogas plant. They are used to analyse the microbial community composition as relative and absolute abundances of microorganisms and to monitor the dynamics of the microbial communities.
Disadvantages	Nucleic acid based molecular biology methods are laborious regarding sample preparation as well as bioinformatic analysis of obtained data. In addition to the quite high per sample costs, expert knowledge is required to apply these methods. As these methods are based on PCR (polymerase chain reaction) for amplification, they depend on the coverage and specificity of the primers. No universal primers for all microorganisms present in biogas reactors are available leading to the risk of missing out on certain organisms. Moreover, PCR-based methods bear the intrinsic risk of PCR artefacts such as chimera formation or preferential amplification. Presented methods rely on different databases for data analysis like 16S rRNA sequence databases for taxonomic assignment of amplicon sequencing reads. The size and quality of these databases strongly influence the results of these methods. Furthermore, absolute abundances of microorganisms based on nucleic acids cannot directly be used for mathematical models based on biomass concentrations such as ADM1.
Advantages	These methods provide warning indicators for process disturbances and support the basis for process optimisation based on insights into the biogas process biology. They do not require laborious cultivation of microorganisms and allow for high sample throughput.
Need for research	Currently, there is a fast development of high throughput sequencing technologies and bioinformatic tools, which will further enhance the application range of these methods. Primers for PCR need to be updated regularly based on recent sequence databases to ensure maximum coverage and specificity. Databases for taxonomic assignment of sequencing reads have to be improved and kept up to date by manual curation and adding new strains being characterised after tediously cultivating and isolating them. Research is still needed to identify distinct organisms that can serve as indicators for process (in)stability.

Microbiology of the biogas process

The biogas process is driven by microorganisms that are highly diverse with respect to metabolism and phylogeny. Only a fine-tuned interplay between the different groups of bacteria and archaea allows for efficient and stable biogas production as they have different optimal growth conditions. Hence, knowledge about the microbial communities in terms of which organisms are present and in which abundance as well as their function is inevitable for in depth process understanding and may help avoid process instabilities.

The decomposition of a substrate into biogas can be described in four steps: hydrolysis, acidogenesis, acetogenesis, and methanogenesis. By hydrolytic activity of extracellular enzymes, macromolecules like polysaccharides, proteins, and lipids are broken down to their monomeric or oligomeric forms. These products of hydrolysis are fermented to volatile fatty acids, alcohols, carbon dioxide, and hydrogen. This fermentation step is named acidogenesis as mainly acidic products are formed. These are further converted into acetate, carbon dioxide and hydrogen during acetogenesis. Whereas the first three steps of anaerobic digestion are carried out by bacteria, the last step is performed by methanogenic archaea. Methane is formed from acetate (acetoclastic methanogenesis) or carbon dioxide and hydrogen (hydrogenotrophic methanogenesis). Methyl compounds formed during acidogenesis, such as methanol or methylamines, are directly converted to methane by methylotrophic methanogens. As an alternative to the acetoclastic methanogenesis, syntrophic acetate oxidising bacteria can convert acetate to hydrogen and carbon dioxide, which are then transformed to methane by hydrogenotrophic methanogenesis. For each of the four steps, characteristic representatives of microorganisms are known. However, there are many organisms present in biogas reactors with unknown function. In biogas reactors, all steps are performed simultaneously, and it is important that there are all microorganisms present facilitating each step. Usually there are several microorganisms capable of catalysing the same reaction. This functional redundancy is the basis for the microbial communities to adapt to different reactor conditions. Only the microorganisms that are best adapted to certain reactor conditions will be active under these conditions.

In the following, molecular biological methods are described by which the microbial communities in biogas reactors can be characterised based on nucleic acids. There are two types of nucleic acids: deoxyribonucleic acid (DNA) and ribonucleic acid (RNA). Their distinction is important because they are used for different analyses. DNA based analysis can be used to quantify the presence of certain microorganisms and their potential functional capabilities based on their genome. RNA can be used to unravel the actual function of microorganisms and to quantify the activity of certain microorganisms.

Sample preparation and extraction of nucleic acids

The molecular biological methods described here are based on nucleic acids extracted from an anaerobic digester sample. DNA and RNA are treated differently concerning sampling and extraction.

Devices and chemicals

DNA extraction:

- DNA extraction kit, e.g. NucleoSpin® Soil Kit (Macherey-Nagel), FastDNA™ SPIN Kit for Soil (MP Biomedicals), or UltraClean® Soil DNA Isolation Kit
- 100 mM Tris/HCl buffer pH 8.0
- optional but recommended: mock communities, e.g. ZymoBIOMICS Microbial Community Standard (Zymo Research), 10 Strain Even Mix Whole Cell Material MSA-2003™ (ATCC), and *E. coli* culture (any strain)

RNA extraction:

- RNA extraction kit, e.g. FastRNA Pro™Soil-Direct Kit (MP Biomedicals), or ZR Soil/FecalRNA MicroPrep™ (Zymo Research)
- DNA removal kit, e.g. TURBO DNA-free™ Kit (Ambion)

Optional:

- RNA protection agent, e.g. RNeasy Protect (Qiagen)
- rRNA removal kit, e.g. Ribo-Zero rRNA Removal Kit (Epicentre)
- cDNA synthesis kit, e.g. SuperScript® VILO cDNA synthesis kit (Invitrogen)

Sampling and extraction of DNA

One-step anaerobic digester samples should be put on ice after sampling and centrifuged (5 min at $20,817 \times g$), then the pellets are stored at $-20\text{ }^{\circ}\text{C}$. Pellets from the acidification reactor of a two-step anaerobic digester system should be washed additionally with 100 mM Tris/HCl buffer pH 8.0 to stabilise the DNA, which is unstable at low pH (STRÄUBER et al. 2016). Unbiased and high-efficiency DNA extraction from anaerobic digester samples is a challenging task. Microbial cell walls have to be broken up without damaging the DNA. The extracted DNA should be free of substances inhibitory to subsequent PCR but DNA extraction efficiency should be high at the same time. Furthermore, all microbial species should be extracted with the same efficiency regardless of their differences in cell membrane and cell wall composition.

Several extraction methods are commercially available, such as NucleoSpin® Soil Kit (Macherey-Nagel) (STRÄUBER et al. 2016), FastDNA™ SPIN Kit for Soil (MP Biomedicals) (LEBUHN et al. 2016) or UltraClean® Soil DNA Isolation Kit (MO BIO Laboratories) (LEBUHN et al. 2016). Please refer to the cited literature for variations applied to the manufacturer's standard protocol. Note that these kits might have worked for certain sample types but might not generally work for all samples equally well. Therefore, standards should be added to the samples to evaluate the DNA extraction bias and efficiency. Mock communities, i.e. defined mixtures of microorganisms, can be used to determine the DNA extraction bias (WILLNER et al. 2012). Commercially available mock communities are for example ZymoBIOMICS Microbial Community Standard (Zymo Research) and 10 Strain Even Mix Whole Cell Material MSA-2003™ (ATCC). The DNA extraction method that leads to relative sequence abundances of the mock community members best resembling the composition

of the spiked mock community should be chosen. Once the DNA extraction method with the lowest bias is determined, the DNA extraction efficiency can be determined by spiking a defined amount of a prokaryote, for example *E. coli*, to the sample and absolutely quantifying by qPCR how much of this amount is left after extraction (see MUMY AND FINDLAY (2004), LEBUHN et al. (2016), and Ch. qPCR).

Extracted DNA should be stored at -20 °C and thawed as few times as possible. Therefore, freezing DNA in smaller aliquots is recommended.

Sampling and extraction of RNA

RNA is sampled as DNA as described above, except that washing with Tris/HCl buffer is not required. However, RNA is degraded faster than DNA under natural conditions. Therefore, a RNA preservative should be added (LEBUHN et al. 2016), for example RNAlater® (Ambion). Alternatively, samples should be processed quickly and frozen in liquid nitrogen. Pellets should be stored at -80 °C (LEBUHN et al. 2016) instead of -20 °C as recommended for DNA. Other methods than for DNA extraction are used, such as FastRNA Pro™Soil-Direct Kit (MP Biomedicals) (LEBUHN et al. 2016) or ZR Soil/FecalRNA MicroPrep™ (Zymo Research). Co-extracted DNA needs to be removed, for example using TURBO DNA-free™ Kit (Ambion). Finally, most RNA analyses require the synthesis of cDNA, i.e. adding a complementary strand to the single strand RNA, for example using SuperScript® VLO cDNA synthesis kit (Invitrogen). For metatranscriptome analysis, rRNA, i.e. a certain type of RNA not important for the analysis, should be removed using for example the Ribo-Zero rRNA Removal Kit (Epicentre) (LEBUHN et al. 2016). Analogous to DNA extraction, RNA extraction efficiencies and biases need to be considered with specific RNA standards (KLOCKE 2017).

Methanogenic community analysis by T-RFLP fingerprinting

The community composition in terms of relative abundances can be determined by so-called molecular fingerprinting of marker genes. By targeting the functional marker gene *mcrA*, which encodes an essential enzyme for methanogenesis (alpha subunit of methyl-coenzyme M reductase), the methanogenic archaea can be identified and their relative abundances be determined. On the RNA level, the transcripts of *mcrA* genes can be targeted to gain insights into the relative activity of specific methanogens. From this data, the dominant methanogenic pathway can be determined, i.e. if acetate is processed via acetoclastic methanogenesis or syntrophic acetate oxidation with subsequent hydrogenotrophic methanogenesis. A prominent method for molecular fingerprinting of methanogenic communities is T-RFLP (terminal restriction fragment length polymorphism) analysis of *mcrA* genes and their transcripts.

Devices and chemicals

- PCR master mix (concentrated; containing Taq polymerase, PCR buffer, MgCl₂, and dNTPs, e.g. by Bioline)
- Forward primer mcrA: 5' GGTGGTGTMGDDTTCACMCARTA 3' (synthesised on demand, e.g. by Eurofins MWG)
- Reverse primer *mcrA*-rev: 5' CGTTCATBGCCTAGTTVGGRTAGT 3', labelled with the fluorescent dye 6-FAM at the 5' end (synthesised on demand, e.g. by Eurofins MWG)

- DNA purification kit, e.g. SureClean Plus (Bioline)
- Restriction endonucleases *Bst*NI and *Mwo*I including the appropriate buffer (e.g. New England Biolabs)
- HiDi formamide (Applied Biosystems)
- GeneScan 500 ROX standard (Applied Biosystems)
- Thermal cycler (e.g. Bio-Rad Laboratories)
- UV-Vis spectrophotometer, e.g. NanoDrop One (ThermoFisher Scientific)
- Capillary electrophoresis instrument, e.g. ABI PRISM 3130xl Genetic Analyzer with POP-7 polymer (Applied Biosystems)

Execution of method

Starting from the extracted DNA or cDNA obtained from RNA, specific fragments of the *mcrA* genes are amplified by PCR. For this purpose, the primers *mcrA*-fwd and *mcrA*-rev are used (STEINBERG & REGAN 2008) with the latter being labelled by a fluorescent dye. The PCR is set up as shown in Tab. 7.2-1 and the PCR cycling conditions are summarised in Tab. 7.2-2.

Table 7.2-1: PCR reaction set-up for amplification of *mcrA* genes for 2x concentrated master mix

Component	Volume [μ L]
PCR master mix	6.25
Forward primer (5 pmol/ μ L)	0.70
Reverse primer (5 pmol/ μ L)	0.70
Nuclease-free water	3.85
DNA sample (diluted to 2–10 ng/ μ L)	1.00
Total	12.00

The PCR product is verified by checking its length by an agarose gel electrophoresis and then purified using the SureClean Plus (Bioline) according to the manufacturer's instructions. Concentrations of cleaned PCR products are measured with a UV-Vis spectrophotometer. Consequently, the cleaned PCR products are enzymatically fragmented by the restriction endonucleases *Bst*NI and *Mwo*I. For each enzyme a separate restriction digestion reaction is set up, see Tab. 7.2-3. PCR products are restricted with *Bst*NI at 60 °C for 2 hours and with *Mwo*I at 37 °C overnight. Afterwards, the restriction fragments are cleaned by ethanol precipitation with 0.1 volume of 3 M sodium acetate (pH 5.5) and 2.5 volume of absolute ethanol. After washing in 70% ethanol, DNA pellets are dried and subsequently resuspended in 10 μ L HiDi formamide containing 2.5% (v/v) GeneScan 500 ROX standard (Applied Biosystems). The latter is a size standard that contains fluorescently labelled DNA fragments of defined lengths. Fluorescently labelled terminal restriction fragments (T-RFs) are separated on an ABI PRISM 3130xl Genetic Analyzer (Applied Biosystems) with POP-7 polymer by injecting for 8 or 15 s.

Table 7.2-2: PCR cycling conditions for amplification of *mcrA* genes

Step	Temperature [°C]	Time	Cycles
Initial denaturation	95	3 min	1
Denaturation	95	20 s	5
Annealing	48	20 s / ramp to 72 °C, 0.1 K s ⁻¹	
Elongation	72	15 s	
Denaturation	95	20 s	25
Annealing	55	20 s	
Elongation	72	15 s	
Final elongation	72	10 min	1
Cooling	8	-	

Table 7.2-3: Set-up of restriction digestion reaction

Component	Amount
Restriction endonuclease (<i>Bst</i> NI or <i>Mwo</i> I)	2 U
Buffer, 10x	1 µL
Cleaned PCR product	40 ng
Nuclease-free water	ad 10 µL

Data analysis

T-RFLP chromatograms are analysed with GeneMapper V3.7 software (Applied Biosystems). Peaks of the size standard have to be checked and assigned manually to the respective fragment length if necessary. Fluorescence signals of T-RFs in the size range of 50–500 bp are extracted as text files (Note: set the minimum peak height of T-RFs to 1) and further analysed according to ABDO et al. (2006). In short, ‘true’ peaks are identified and the relative T-RF abundances are calculated by dividing the individual T-RF peak areas by the total peak areas (100%). Eventually, T-RFs are taxonomically identified by assigning them to methanogenic genera or families with known *mcrA* sequences. Therefore, T-RF lengths are compared to a database (BÜHLIGEN et al. 2016). T-RFLP analysis with either *Bst*NI or *Mwo*I should result in similar community compositions. Based on this data, multivariate statistics like ordination plots can be applied using the Vegan package as implemented in the open-source software R (OKSANEN et al. 2016).

Archaeal and bacterial community analysis by amplicon sequencing

To extend the community analysis to bacteria, universal phylogenetic marker genes, i.e. 16S rRNA genes, are targeted by high-throughput next-generation amplicon sequencing. This method has a higher resolution than fingerprinting methods and provides information on the community composition by means of identity of microorganisms down to genus level and their relative abundances. T-RFLP fingerprinting can be also applied to analyse the bacterial community targeting the 16S rRNA genes. However, a taxonomic assignment based on T-RF lengths is not possible as the bacterial communities are considerably more diverse than the methanogenic communities. As for some organisms the metabolic function is known, the results of the amplicon sequencing can be used to infer the abundance of specific functional groups. Furthermore, diversity indices can help assess the process stability and resilience towards disturbances.

Devices and chemicals

- PCR master mix (concentrated; containing Taq polymerase, PCR buffer, $MgCl_2$, and dNTPs, e.g. by Bioline)
- Forward Primer 341f: 5' TCGTCGGCAGCGTCAGATGTGTATAAGAGACAGCCTACGGGNGG-CWGCAG 3'
- Reverse Primer 785r: 5' GTCTCGTGGGCTCGGAGATGTGTATAAGAGACAGGACTACHVGG-GTATCTAATCC 3'
- DNA quantification system, e.g. Qubit® Fluorometer 3.0 (Life technologies) with corresponding Qubit® dsDNA HS Assay Kit
- Agencourt AMPure XP kit (Beckman Coulter Genomics)
- MiSeq Reagent Kit v3 600 cycles (Illumina)
- Nextera XT Index Kit (Illumina)
- PhiX Control Kit v3 (Illumina)
- thermocycler (e.g. Bio-Rad Laboratories)
- magnet plate or rack
- MiSeq System (Illumina)

Note that amplicon sequencing is described here using Illumina's MiSeq platform as it is widely used. Other sequencing platforms allow for amplicon sequencing as well. However, protocols and chemicals are different.

Execution of method

The extracted DNA is used for PCR amplification. In contrast to T-RFLP fingerprinting as described above, the variable regions V3 and V4 of the 16S rRNA genes are amplified using the 341f forward and 785r reverse primers (KLINDWORTH et al. 2013). Amplicon sequencing of the 16S rRNA genes including sample preparation is done according to the manufacturer's instructions (ILLUMINA 2013). In short, PCR products are purified using magnetic beads (AMPure XP beads) after the first PCR amplifying 16S rRNA gene fragments, and subsequently indices get attached by another PCR called index PCR. By using indices up to 384 samples can be sequenced simultaneously (multiplexing). After purification with magnetic beads, the PCR products are fluorometrically quantified, pooled to a library and

loaded on the MiSeq system. A sequencing run yields up to 25 million sequence reads in total. With the MiSeq v3 sequencing kit, the maximum read length is 300 bp. The 16S rRNA gene amplicons are sequenced in forward direction from the start and in reverse direction from the end of the amplicon. By this, forward and reverse reads are obtained (paired-end reads).

Data analysis

Typically ten to hundreds of thousands of reads are generated per sample. These reads are analysed using a bioinformatics software collection like mothur, QIIME, or its successor QIIME2 (BOLYEN et al. 2019, CAPORASO et al. 2010, SCHLOSS et al. 2009), which enables sequence analysis from raw data to multivariate statistical analysis. Here, the steps of amplicon sequencing data analysis are explained in general as they are implemented differently in the software collections. First, after de-multiplexing, i.e. separating the obtained reads according to the indices, forward and corresponding reverse reads are combined by overlapping them. Secondly, reads are quality-filtered using a Q-score threshold of 30 for example. Thereafter, chimeric sequences have to be removed. Chimeric sequences are PCR artefacts generated when the elongation is not completed within one PCR cycle and the DNA fragment serves as primer for the next cycle binding to template DNA of another species present in the sample. After chimera filtering, the combined and filtered reads are clustered according to sequence similarity either by exact sequence inferring (CALLAHAN et al. 2016) or using a similarity threshold, i.e. 97% sequence similarity. Inferred exact sequences, so-called amplicon sequence variants (ASVs) or cluster of sequences, so-called operational taxonomic units (OTUs) are assigned to taxa by comparing the sequences to a dedicated 16S rRNA gene sequence databases like MiDAS (McILROY et al. 2015). Finally, ASVs/OTUs are summarised according to their taxonomic affiliation and relative abundances of each ASVs/OTUs are calculated based on the total number of reads (100%).

Quantitative community analysis by qPCR

While T-RFLP fingerprinting and amplicon sequencing give only relative abundances, other methods like qPCR (quantitative real-time polymerase chain reaction) are applied to obtain absolute abundances. qPCR is essentially a common PCR as described above but with a fluorescent marker that binds to double-stranded DNA or cDNA to quantify the amplification process. This fluorescent marker can be a hybridisation probe (also called TaqMan™ probes) or an intercalating dye such as SYBR Green (SMITH & OSBORN 2009). Hybridisation probes bind specifically to a certain DNA sequence and are well suited to quantify a specific gene or transcript of known sequence (e.g. only a certain gene of a certain species). Intercalating dyes bind non-specifically to any DNA and are therefore useful if not all sequences are known like in biogas reactors when all 16S rRNA genes of several hundred different species shall be quantified. Alternatively to qPCR, a similar method called digital droplet PCR (ddPCR) (KIM et al. 2015) can be used, which uses PCR reactions with fluorescent markers in thousands of droplets enabling absolute quantification without a standard. In both methods, absolute abundances of microorganisms based on gene copy per volume of reactor content can be calculated. Combined with community compositional data, absolute abundances of individual taxa can be inferred.

Devices and chemicals

- DNA quantification system, e.g. Qubit® Fluorometer 3.0 (Life technologies) with corresponding Qubit® dsDNA HS Assay Kit
- real-time qPCR system, e.g. CFX96 Touch™ Real-Time PCR Detection System C1000 Thermal Cycler (Bio-Rad Laboratories)
- primers, e.g. same primers for *mcrA* and 16S rRNA genes as described above for T-RFLP fingerprinting or amplicon sequencing, or specific primers for a certain taxon
- qPCR standard

Intercalating dye assay:

- intercalating dye, e.g. SYBR green
- PCR master mix (often combined with intercalating dye), e.g. KAPA Master Mix (KAPA SYBR® FAST Bio-Rad iCycler®)

Hybridization probe assay:

- hybridisation probe
- PCR master mix (without dye)

Execution of method

A qPCR assay is prepared in the same way as a common PCR except the addition of the fluorescent marker and the PCR cycling conditions are summarised in Tab. 7.2-4. In addition, for both intercalating dye and hybridisation probe based assays, an external, exactly quantified standard is needed either in a dilution series to construct a standard curve (LEBUHN et al. 2016) or a single concentration to perform a one-point calibration (BRANKATSKCH et al. 2012). This standard can be a circular or linearised plasmid, or a PCR product containing the target gene, i.e. the gene that is supposed to be quantified (OLDHAM & DUNCAN 2012).

In addition to samples and standards, a qPCR assay should include a non-template control (NTC), i.e. a PCR reaction containing all components but no DNA or cDNA. This NTC should not show any amplification, i.e. no fluorescence signal. All samples, standards, and NTCs should be run at least in triplicates. For further best practices, please refer to the MIQE guidelines (BUSTIN et al. 2009).

In addition to generic assays of *mcrA* and 16S rRNA genes that cover a broad range of different taxa, qPCR assays can be designed for the detection of certain taxa by using taxon-specific primers and hybridisation probes (Yu et al. 2005; MAY et al. 2015).

As mentioned above, the DNA extraction efficiency can be determined by spiking a defined amount of *E. coli* or another microorganism to a sample prior to DNA extraction. The amount of *E. coli*-DNA extracted from the sample can be quantified by qPCR amplifying the *murA* gene using specific primers and a hybridisation probe following the protocol of LEBUHN et al. (2016).

Table 7.2-4: qPCR protocols for *mcrA* and 16S rRNA genes using the same primers as described above and the KAPA SYBR® FAST Bio-Rad iCycler® master mix

qPCR step	Temperature [°C]	Time	Cycles
<i>mcrA</i>			
Initial denaturation	95	3 min	1
Denaturation	95	5 s	40
Annealing/Elongation	60	30 s	
Melting curve analysis	65	5 s	
	95	In 0.5 K steps	
16S rRNA gene			
Initial denaturation	95	5 min	1
Denaturation	95	15 s	40
Annealing	55	20 s	
Elongation	72	30 s	
Melting curve analysis	65	5 s	
	95	In 0.5 K steps	

Data analysis

Data analysis can be performed using the software provided by the real-time qPCR system manufacturer (e.g. CFX Maestro Software from Bio-Rad Laboratories). Additionally, freeware such as LinRegPCR can be used (RUIJTER et al. 2009). The melting curve should be analysed to check for undesired PCR side-products, which would lead to biased quantification results. For further best practices, please refer to the MIQE guidelines (BUSTIN et al. 2009).

The absolute abundance of a certain gene or transcript derived from qPCR needs to be corrected for the DNA or RNA lost during extraction by adding a standard to the samples prior to nucleic acid extraction (see Ch. Sample preparation). The resulting absolute quantities of genes can be combined with amplicon sequencing or T-RFLP fingerprint analyses to infer the amount of certain microbial taxa in a sample.

In-depth community analysis by metagenomics

Beyond community analysis based on marker genes, generic methods such as metagenomics give insight into the metabolic capabilities of the involved microorganisms by sequencing the total DNA and hence, all genes present in a biogas reactor. Illumina sequencing platforms are the state-of-the-art application for metagenomics because they

provide highest data throughput, lowest per-base cost and short but high-quality paired-end oriented (forward-reverse) genome fragments (GOODWIN et al. 2016). Annotation of phylogenetic diversity and metabolic potential is the goal of the metagenomic analysis.

Devices and chemicals

- DNA quantification system, e.g. Qubit® Fluorometer 3.0 (Life technologies) with corresponding Qubit® dsDNA HS Assay Kit
- Agencourt AMPure XP kit (Beckman Coulter Genomics)
- High Sensitivity DNA Kit (Agilent Technologies)
- Nextera® XT DNA Library Preparation Kit (Illumina)
- Nextera® XT Index Kit for 24 Indexes (96 samples) (Illumina)
- MiSeq Reagent Kit v3 600 cycles paired-end (Illumina)
- Agilent 2100 Bioanalyzer with the High Sensitivity DNA Analysis Kit and Reagents (Agilent Technologies)
- MiSeq (Illumina)

Note that the following description of metagenomics is based on the Illumina MiSeq platform. It is also possible to use other platforms like Illumina HiSeq or Oxford Nanopore Technologies, but protocols and material are different.

Execution of method

After the DNA extraction and subsequent quantification the DNA is diluted to 0.2 ng/μL. From this diluted DNA, the sequencing library is generated according to the protocol of Nextera® XT DNA Library Preparation Kit (ILLUMINA 2018). The Nextera® XT Index Kit for 24 Indexes (Illumina) is used for multiplexing samples pursuant to the Nextera® Low Plex Pooling Guidelines (Illumina 2016). Indexed libraries are purified using Agencourt AMPure XP beads according to the manufacturer's instructions. After resuspending the purified library, the library quality is verified using the Agilent 2100 Bioanalyzer with the Agilent High Sensitivity DNA Kit (Agilent Technologies) and the Qubit Fluorometer using dsDNA HS Assay Kit (Thermo Fischer Scientific). Several libraries can be sequenced simultaneously by pooling them (multiplexing) and subsequent quality control using the Agilent 2100 Bioanalyzer and Qubit Fluorometer. Finally, the sequencing process can start using MiSeq Reagent Kit v3 (Illumina) with 600 cycles (2x300 bp reads). As for amplicon sequencing, forward and reverse oriented reads are obtained.

Data analysis

After sequencing millions of short reads are generated with a read length of around 180 bp. In order to infer the phylogenetic diversity and metabolic potential from the sequence data, bioinformatics tools have been deployed. The first step of metagenome analysis is the pre-processing of the raw reads removing short reads (e.g. less than 30 bp length), adapter trimming, and quality control (e.g. minimum Q score 30) using tools like Trimmomatic (BOLGER et al. 2014) and FastQC (<http://www.bioinformatics.babraham.ac.uk/projects/fastqc/>). Secondly, by de novo assembly, short reads are combined into longer contiguous overlapping DNA segments (contigs) using a de Bruijn graph algorithm. Thereby, reads are split into fragments equal to a predefined size, the k-mer size. These k-mer sized

fragments will be overlapped into graphs and combined by using Eulerian path (THOMAS et al. 2012). The k-mer size strongly influences the resulting assembly. Greater k-mers lead to a higher number of smaller contigs whereas smaller k-mers lead to a higher chance to cover low abundant species (QUINCE et al. 2017). To avoid this trade-off, IDBA-UD (Peng et al. 2012) or metaSPAdes (Nurk et al. 2017) are the recommended assembly tools, because it uses a large range of k-mers (51 to max. read length). After assembly, the contigs are clustered into taxon-specific bins (binning). In order to use this information, the sequences of each bin should be assembled again. The last step is the annotation whereby taxonomic and functional information is assigned to contigs using NCBI taxonomy and functional databases, e.g. eggnog, respectively. For this purpose, the annotation tool MEGAN6 can be used (HUSON et al. 2016). Finally, the community composition and potential function can be analysed by statistical methods. By metagenomics, the metabolic potential of the community is obtained - the actual function and activity is determined by metatranscriptomics and metaproteomics approaches.

Microbial resource management to optimise the biogas production

Insights into the microbial community structure and function gained by the described methods help improve the biogas production by providing in-depth process understanding on the level of process biology. Thereby, biogas production can be increased and process instabilities avoided. Diversity indices based on the obtained community structure can help evaluate the process stability and resilience towards disturbances.

Amplicon sequencing in combination with qPCR has been used to evaluate the impact of the inoculum on process performance (DE VRIEZE et al. 2015). The inoculum had strong impact on biogas production during process start-up and on the ammonia tolerance, which was reflected in the microbial community structure. Beside inoculum, process conditions have also an impact on the microbial communities. Molecular biological approaches are used to correlate microbial community shifts to changes in process conditions in general (THEUERL et al. 2015) or to changes in specific parameters like trace element supply (WINTSCHE et al. 2018). Furthermore, the impact and the capability of degradation of inhibitory substances like antibiotics or plant secondary metabolites can be assessed by community analysis (CETECIOGLU et al. 2015; POPP et al. 2015). An integrative omics approach using 16S rRNA gene amplicon sequencing, metagenomics and metatranscriptomics revealed a partial lack of cellulolytic enzymes identifying the hydrolysis of the substrate as potential bottleneck (GÜLLERT et al. 2016). Pathogen concentrations in digestate are a concern for its use as fertiliser. Pathogens can be identified by next-generation sequencing and quantified by qPCR (KLOCKE 2017). The "metabolic quotient" relates qPCR results to the methane production rate as early warning system for process disturbances (MUNK et al. 2012). Besides known organisms, omics approaches are also deployed to discover new phylotypes (HAGEN et al. 2017). Hitherto, still many organisms responsible for important steps of the AD process are unknown.

The anaerobic digestion model 1 (ADM1), an ordinary differential equation based model popular in anaerobic digestion research, and other mechanistic models represent microbial biomass as dry mass or chemical oxygen demand (COD). Note that absolute gene abundances measured by qPCR or ddPCR as well as relative gene abundances measured by amplicon sequencing or T-RFLP fingerprinting are not the same as biomass (Fig. 7.2-1). One genome can contain several copies of a gene. One cell can contain several copies of its genome (ploidy). The dry weight of a cell depends strongly on the species and ranges over three orders of magnitude for bacteria (MUNK et al. 2017). Therefore, it is still difficult to combine molecular biology data with common mathematical models used in the biogas sector.

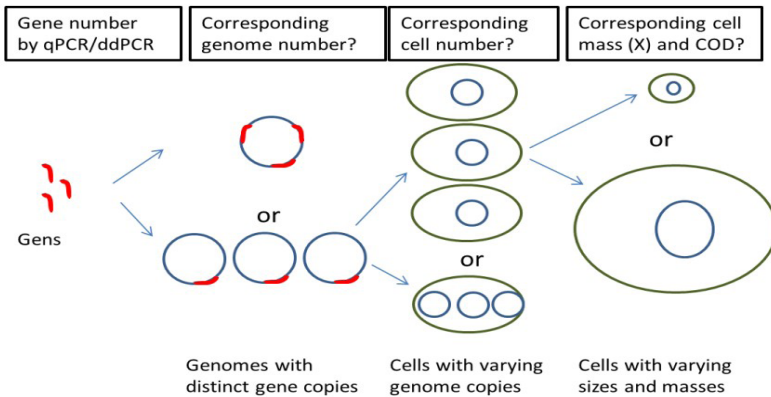

Figure 7.2-1: Challenges in converting gene-based abundances to microbial biomass or COD for modelling purposes (Source: UFZ)

7.3 Continuous fermentation tests

Marc Lincke, Björn Schwarz; Fraunhofer IKTS

Status	Development completed, ready to be used.
Associated standard	VDI GUIDELINE 4630 (2006)
Area of application	<ul style="list-style-type: none"> Type of substrates: biogenous substrates of any composition TS range: 0%–100%, whereupon – depending on the TS – a mixture-TS of the input of no more than 15% is established through addition of water or other liquid substrates. Particle sizes: maximum length = 3 cm (precrushing, if necessary)
Limitations of the method	None, since any decomposition inhibition by the substrates to be tested is also subject of the analysis
Need for research	<ul style="list-style-type: none"> Comparability to results of other methods Upscaling to the industrial scale range (advantage IKTS: laboratory and pilot plant [10 m³] usable)

With the help of continuous fermentation tests, statements regarding long-term behaviour and process stability of anaerobic degradation processes can be made with respect to specific gas yields and gas qualities under the following conditions and aspects:

- impact of organic loading rate and retention time
- multi-stage and multi-phase process management
- concentration and impact of inhibitors
- impact of nutrients and trace substances
- impact of mixing and feeding intervals

Since the bandwidth of possible test apparatuses and possible test objectives is very high, no standardised test methods for continuous fermentation tests are existent at the moment. Some indications regarding a possible test setup and the execution of continuous tests are provided in the VDI GUIDELINE 4630. Analogous to the descriptions regarding the gas yield test, the execution of quasi-continuous fermentation tests in the laboratory-scale fermentation systems of Fraunhofer IKTS is described subsequently as an example.

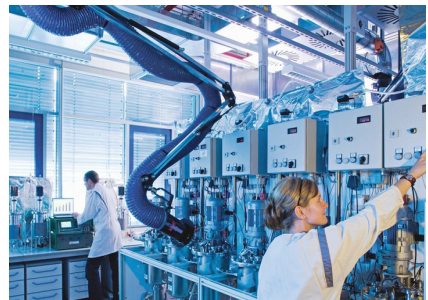

Figure 7.3-1: Laboratory scale anaerobic digestion plants at the laboratory of Fraunhofer IKTS

Sampling and sample preparation

When taking a sample, a representative sample must be ensured. The recommendations of VDI GUIDELINE 4630 regarding the sampling procedure have to be taken into consideration. In order to keep the substrate at a consistent quality, a suitable storage method is required. This can comprise a dry storage at room temperature (e.g. straw) or a storage at room temperature (e.g. straw) or a storage in a refrigerator (e.g. silages) all the way to frost storage of substrates that spoil easily (e.g. biowaste fractions). Long-fibre substrates (e.g. straw, grass) have to be comminuted (cutting mill, mincer) prior to conservation and/or feeding in order to avoid operational problems such as clogging and wrapping around the stirrer. A maximum fibre length of 3 cm has to be set for the test plants described below.

Materials and devices

The laboratory-scale fermentation systems in essence consist of the following components:

- stainless steel reactor, gas-tight
- heating (heating sleeve or a jacketed reactor with water heating system)
- central stirrer with gas-tight passage through the reactor cover
- measuring sensors for temperature and pH-value as well as, where applicable redox-potential
- feed opening with funnel (sealable, gas-tight)
- bleeder (for cleaning and emptying)
- testing opening with immersion pipe
- gas extraction nozzle
- quantitative and qualitative gas assessment (gas meter Milligascounter® MGC-1 V3.0), gas bag, gas analysis device)
- measuring and control technology

Based on experience, a thorough tightness testing of all system components should be carried out upon commissioning of the plant as well as at regular time intervals. The stirrer ducts in the reactor cover are particularly susceptible to leaks. Massive units consisting of the stirrer and the shaft sealing have been tested and proven at IKTS (c.f. Fig. 7.3-2).



Figure 7.3-2: Continuous laboratory digestion at Fraunhofer IKTS

Method

Depending on the test plan, the reactors are started up with digestate of an industrial scale biogas plant or with the digested sludge of a communal sewage treatment plant. For the verification of a synchronism of the reactors, they are fed with the same input substrate over the course of several days or weeks. Subsequently, the conversion of the substrates is carried out depending on the test plan.

The necessary feeding quantities are calculated based on the intended organic loading rate, in consideration of the substrate characteristics and the reactor size. Additional feedings of water or the liquid phase of the separated reactor-internal digestate have an impact on the hydraulic retention time of the substrates. Taking the reactor size into account, these quantities also have to be selected in such a way that the hydraulic retention time corresponds to the test objective. Furthermore, the input solids content and thereby also the total solids content in the reactor is adjustable via the amount of liquids added. High input solids contents (> 10–12%TS) have to be avoided due to possible problems with the agitation and the resulting formation of a floating sludge layer. This critical value is essentially dependent on the design of the reactors and the stirrers.

By default, a daily feeding of the fermenters should be performed seven days a week. If a feeding on weekends is not possible, the following feed distribution has proven itself for the homogenisation of the gas production of maize silage or similarly decomposable substrates:

Table 7.3-1: Distribution of the feeding amounts of continuous fermentation tests

Day of the week	Monday	Tuesday	Wednesday	Thursday	Friday
Feeding amount relative to the average dose per day	160 %	80 %	80 %	90 %	90 %

Otherwise, in the case of equal feeding amounts every workday, severely increasing gas peaks occur over the course of the week since more and more biogas, that is generated by substrates of preceding feeding days, is adding up towards the end of the week. In addition, the reactors are best able to process a larger feeding load after a feeding break on the weekend.

For a default feeding, the substrates required in accordance with the test plan are weighed out in advance and provided in beakers. At the IKTS, the addition of the substrates is performed through manual feeding via a feeding funnel on the cover of the reactors. The extraction of digestate is performed twice a week in order to generate sufficient amounts for the further processing on the one hand, and in order to minimize the workload on the other. The amount extracted is – based on the fill level of the reactors to be measured – specified in such a way that an average fill level is maintained for all comparison reactors. The extraction of a sample from the fermenter is carried out with the help of an immersion pipe. The sample is pushed out of the reactor by positive pressure which is generated with nitrogen in the gas space. Fermentation substrate extracted in excess is returned to the reactor with the input substrates.

All input and output substances are analysed in accordance with the analysis plan immediately afterwards the sampling. With different reactor sizes, even more complex multi-stage procedures, such as a separate upstream hydrolysis or fermenters operated in series, can be replicated, too.

During the operation of the laboratory-scale reactors, pH value, temperature, redox potential and the amount of gas produced are recorded digitally. The biogas produced is captured in gas bags and is discontinuously tested for its composition (CH_4 , CO_2 , H_2S , O_2). For further analysis, a standardisation of the gas amounts in accordance with Eqs. 91–93 is carried out.

Pilot scale

The biggest disadvantage of tests at laboratory scale is the limitation of the test setup due to the substrate particle size as well as the substrate quantity. Therefore, the partial substrate amounts that are utilised relative to the type of substrate to be tested are not always representative. Furthermore, it is hardly possible to test the impact of the continuous operation effects of industrial scale devices, for example for the substrate pre-treatment, on the biogas production with reasonable expenditures. With the help of pilot plants for fermentation tests, for instance with a reaction volume of 10 m^3 , these weak spots in the significance of the laboratory tests can be compensated. The test results achieved are – in comparison to laboratory tests – significantly more practice-oriented with respect to the representativeness of the samples, the functionality of peripheral preparation technologies as well as to the assessment of the mixing behaviour in the reactor.

As a connecting link between systematic laboratory tests with a large variation potential and the industrial-scale application, a pilot plant represents an important stage for process developments.

Fig. 7.3-3. shows, as an example, the pilot fermentation plant of Fraunhofer IKTS. The pilot plant consists of the following essential components.

- substrate pre-treatment container with hopper, screw extrusion press and bioextruder
- mixing tank/separate hydrolysis stage
- feeding screw with solids hopper
- technology container with fermentation substrate distribution, heating system and control system
- two heated digesters with a digester volume of a total of 10 m^3
- dual-configured gas path with two gas reservoirs and condensate trap
- gas purification (activated carbon)



Figure 7.3-3: Pilot biogas plant Fraunhofer IKTS

7.4 Continuous fermentation tests

Katrin Strach, DBFZ

Status	Development mostly completed, usable.
Associated standards	Modelled after VDI GUIDELINE 4630 (2006)
Area of application	All biogenous substrates in the TS range of 0–100%; the TS of the substrate mixture should not exceed 35 %.
Limitations of the method	The maximum particle size of the input is dependent on the digester geometry, the maximum organic loading rate on the mode of feeding.
Need for research	Up-scaling into industrial-scale operation; comparability to other methods (e.g. batch test); automatic feeding systems in order to achieve a continuous feeding; new types of feeding in order to improve mixing through; reproducibility of the tests

Continuous fermentation tests (here, fully mixed through stirred tank) are carried out in order to obtain statements regarding the fermentability of biogenous substrates under a continuous mode of operation. In this, data regarding gas yield, gas composition, the VS decomposition and any process disruptions and/or process limitation occurring can be determined under defined conditions. In the case of a sufficient test duration (at least 3 times the retention time), these tests can reflect the stationary state, i.e. the changes to the process parameters are zero.

Continuous tests are carried out in order to gain insights regarding:

- specific gas yield in the case of
 - different organic loading rates and hydraulic retention times as well as multiphase and/or multi-stage process flow
 - different feeding regime, mixing through and fermentation temperature
 - impact of additives (e.g. enzymes)
 - application of digestion processes
- accumulation and impact of inhibitors
- material flows, mass balances and concentrations of substrates and inert substances in the stationary state
- obtaining achievable degree of degradation of the organic components.

For continuous fermentation tests there are to date no standardised methods due to the large number of variants regarding the setup and execution. VDI GUIDELINE 4630 provides action recommendations regarding select process flows and describes fundamental aspects. The following presentation describes the approach for continuous fermentation tests in the quasi-continuously operated stirred tank reactor at laboratory scale.

Substrate sampling and storage

The substrates must be obtained as a representative sample; this is the decisive prerequisite for the meaningfulness of the test. In addition to VDI GUIDELINE 4630, rules and regulations from the waste industry or water analysis may also provide good action recommendations for the sampling, depending on the type of substrate. In order to keep the quality of the substrate constant, a preserving storage must take place. Dry substances can be stored dry at room temperature. Substances that spoil easily or contain highly volatile components should be subjected to a vacuum, sealed in transparent film, and put into cold or frozen storage. In the case of freezing, it must be taken into consideration that a disintegration of the cells may occur and as such a sort of pretreatment may take place. Otherwise, the input substance must, in principle, be placed in cold storage (+4 °C). A substrate pretreatment for easier handling in the test should be avoided, if possible, in order to ensure real-life conditions. Changes to the substrate, such as cutting or crushing, can result in a changed degree of degradation.

Devices and materials

A test setup for carrying out a continuous fermentation test includes the following components:

- PVC reactor (Fig. 7.4-1)
 - double-walled
 - feeding nozzle with funnel (immersed)
 - stirrer shaft immersion
 - bleeder for retrieval of digestate
 - gas extraction nozzle for gas discharge and pressure equalization
 - inspection window
- stirrer system/stirrer with gas-tight passage through cover
- heating by means of circulation thermostat
- gas meter
- gas bag
- gas analysis device
- possibly measuring and control technology

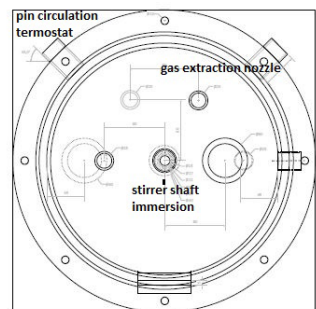
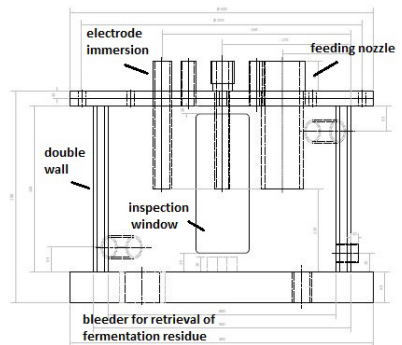

Figure 7.4-1: Technical drawing of a digester with a gross volume of 15 L

The reactors are manufactured in double-walled construction. Located in the shell is water which circulates and is heated by means of a circulation thermostat. The stirrer system is installed as central stirrer system. Liquid fermentation mixtures are mixed through with paddle or pitched-blade stirrers. For highly viscous media, similar models of anchor stirrers have been developed. The test setup must be gas-tight. Prior to commissioning, a thorough leak test of the system should take place. Particularly susceptible to leaks are the cover gasket, the gas extraction nozzle and the hose connections. Fig. 7.4-2 shows six biogas reactors in the complete test setup.



Figure 7.4-2: Laboratory for continuous fermentation tests at the DBFZ

Execution method

The reactors are operated in the known temperature range for mesophilic and/or thermophilic mode of operation. A continuous mixing through is taking place in the rotational frequency range of $50\text{--}100\text{ min}^{-1}$. In the case of paddle and pitched-blade stirrers, the stirring is carried out at a higher rotational frequency. A method that is gentler to the microbiology is the slower homogenisation with anchor stirrers.

At the start of the test, the digester is filled with digestate/fermentation mixture of a biogas plant which, if possible, is fed with substrates that are similar to those in the test plan. In the ideal case, the organic loading rate of the plant corresponds to that of the test plan. In accordance with the organic loading rate and retention time specified in the test plan, the substrate is weighed out fresh daily. Prior to feeding, digester content is retrieved via a spherical valve that is located at the bottom of the reactor. It is used to conduct process-accompanying analytics and/or disposed off as discharge. In this, it has to be taken into consideration that dead zones may occur in the discharge pipe and/or on the digester's floor in which solid components are deposited. To obtain a sample that is as representative as possible, it is therefore recommended to first return a correspondingly large amount of fermentation mixture and to retrieve the sample thereafter. The feeding is carried out at least once a day manually via the feeding funnel. To make dry or long-fibre substrates more

flowable for the feeding, they can be diluted with fermentation mixture. In the case of very liquid input substances, the feeding is carried out by means of hose pump multiple times a day. It must be ensured that the fill level in the reactor remains constant in any case. This can be checked visually with the help of a scale at the inspection window or by means of a measuring rod via the feeding pipe. During the digestate retrieval and the feeding, the pressure equalization in the system must be ensured in order to avoid the entry of air or negative pressure at the gas meters. For this, a gas bag filled with biogas is attached to a bypass on the digester cover and the measurement of the gas amount is temporarily disconnected.

For process control, the pH value in the discharge is determined daily (or, even better, continuously in the process). Depending on the test plan and necessity, the parameters VOA, VOA/buffer capacity, $\text{NH}_4\text{-N}$ (TAN), TS/VS and/or COD and the individual acid spectrum are recorded 1–2 times per week. The biogas generated is fed through a gas meter in order to determine its volume. From there, it is passed into a gas bag and automatically checked for its composition by a process analysis system. In this, the concentration of the gases methane, carbon dioxide, oxygen and hydrogen is determined.

The adaptation to the desired process state (in the start-up phase or over the course of the test) – in the majority of tests, this is associated with an increase of the organic loading rate – is therefore conducted differently. In the case of well-researched input materials, the load can continuously be increased every day by $0.1 \text{ g}_{\text{VS}} \text{ L}^{-1} \text{ d}$. In this, an eye must be kept on the gas production and the concentration of organic acids in order to be able to intervene in case an overloading of the process occurs.

An optional approach is to increase the organic loading rate by $0.5 \text{ g}_{\text{VS}} \text{ L}^{-1} \text{ d}$ and then wait until the process parameters remain unchanged over the course of approx. two weeks. Then, the next increase can take place. This variant is considerably more time-consuming. If the digester is fed with a constant amount and composition of substrate and the fill level is maintained, the process approaches the stationary state. In the stationary state, the change of the process parameters is zero. Inert substances, in this, show the following temporal progression of the concentration in response to a step function.

Tracer concentration in a stirred tank cascade due to a step function (R1 und R2)
retention time 80 d; $C/C_0=1-\exp(-t/t_0)$

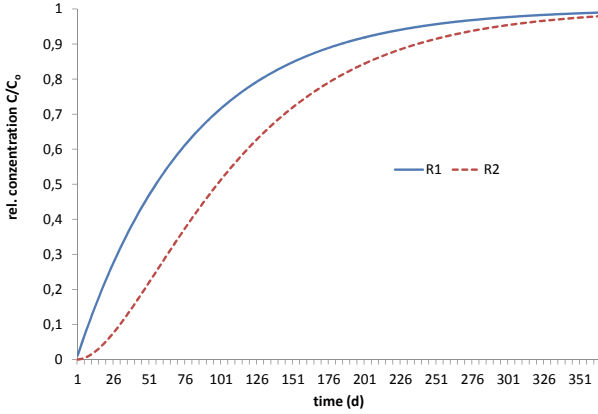

Figure 7.4-3: Tracer concentration in a stirred tank cascade due to a step function in the case of a retention time of 80 d (Source: DBFZ)



Figure 7.4-4: Gas production and organic loading rate of two continuous fermentation tests in parallel test (Source: DBFZ)

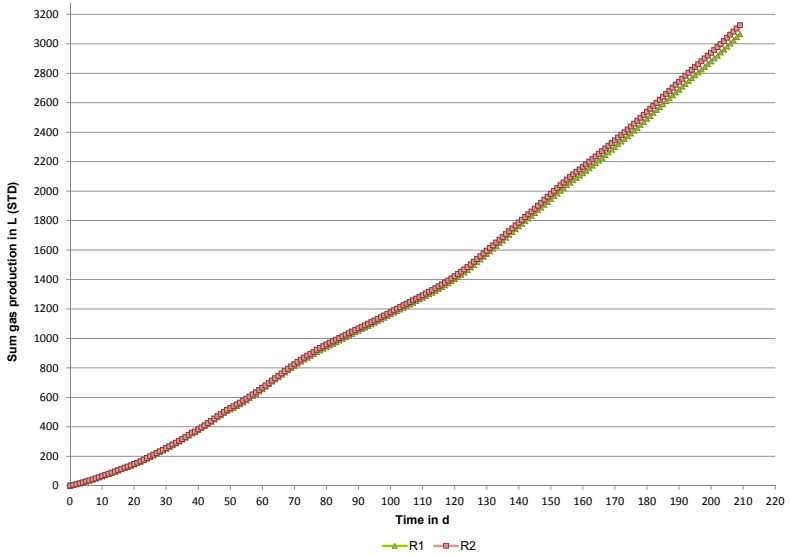

Figure 7.4-5: Cumulated gas production of two digesters in parallel operation (Source: DBFZ)

Corresponding to Fig. 7.4-3, the process is approaching the stationary state; depending on the test objective, the test can be terminated in the case of a sufficient approximation. However, it must be taken into consideration that the biological system may also have a delayed response to changes in the process. As such, the temporal forecast, for example, of process fluctuations due to deficiency symptoms (e.g. lack of trace elements) is very difficult.

Weekend feeds

For a continuous process flow, a feeding should also take place on weekends and holidays. To shorten the work flow, on weekends the fermentation mixture is withdrawn only in exceptional cases. The correct fill level is then once again established the next workday.

Analysis

If it cannot be ensured that the gas production is measured every day at the exact same time, the gas meter reading and the corresponding time must be recorded twice a day for the calculation of the daily biogas volume produced. Between the two reading points, at least 30 min should have passed, the second reading must be carried out shortly before the daily feeding. Then, the biogas volume flow standardised to 24 h can be calculated with the following equations.

First, the average gas production is determined.

$$V = \frac{GM_1 - GM_2}{\Delta t} \quad 79$$

V	Average gas production	mL h ⁻¹
GM ₁	Gas meter reading at first reading	mL
GM ₂	Gas meter reading at second reading	mL
Δt	Time difference between 1 st and 2 nd reading	h

Since the feeding does not take place every day at the same time, the time difference to 24 h is taken into consideration.

$$\Delta t_{24} = 24 - \Delta t_F \quad 80$$

Δt ₂₄	Time difference to 24 h	h
Δt _F	Time difference between the point in time of feeding on the current test day and the point in time of feeding on the preceding test day	h

The conversion calculation to standard pressure (101.325 kPa), standard temperature (273.15 K) and the standardisation to dry gas are carried out by means of the Antoine equation (BIERWERTH 2011).

$$V_{STD} = (V \cdot \Delta t_{24} + GM_{2-2}) \cdot \frac{\left(\left(p_a - 10^{\frac{7.19621 - \frac{1730.63}{233.426 + T_a}}{[kPa]}} \right) + \Delta p_{GM} \right) \cdot 273.15K}{101.325kPa \cdot (273.15K + T_a)} \quad 81$$

GM ₂₋₂	Gas production since the last feeding according to the gas meter reading	mL
V _{STD}	Standardised gas volume	mL (STP) d ⁻¹
p _a	Ambient pressure	kPa
Δp _{GM}	Pressure loss of the gas meter	kPa
T _a	Ambient temperature	°C

For the calculation of the TS decomposition, the masses of the input and the discharge as well as the TS contents are put in relation to one another. Since some substrates and digestates contain volatile substances that get lost in the determination of the total solids in accordance with DIN 12880, the total solids are corrected with the concentration of volatile organic acids.

$$TS_{\text{decomp}} = \frac{(m_{\text{TS,inp}} + c_{\text{inp}}) - (m_{\text{TS,dis}} + c_{\text{dis}})}{(m_{\text{TS,inp}} + c_{\text{inp}})} \cdot 100 \quad 82$$

TS_{decomp}	Decomposition of the total solids	%
$m_{\text{TS,dis}}$	Mass of total solids of the discharge	g
$m_{\text{TS,inp}}$	Mass of [total solids] of the input	g
c_{inp}	Concentration of the volatile organic acids in the input (inlet)	g kg ⁻¹ FM
c_{dis}	Concentration of the volatile organic acids in the discharge	g kg ⁻¹ FM

The mass of the output can – at constant fill level – be determined through weighing. A calculation of the digestate with the following equation is optional.

$$m_{\text{biogas}} = \left(M_{\text{CH}_4} \cdot \frac{V_{\text{STD}} \cdot c_{\text{CH}_4}}{V_m} \right) + \left(M_{\text{CO}_2} \cdot \frac{V_{\text{STD}} \cdot c_{\text{CO}_2}}{V_m} \right) + \left(M_{\text{H}_2\text{S}} \cdot \frac{V_{\text{STD}} \cdot c_{\text{H}_2\text{S}}}{V_m} \right) + m_{\text{wv}} \quad 83$$

m_{biogas}	Mass of the biogas produced	g
$M_{(x)}$	Molar mass of the respective index	g mol ⁻¹
V_m	Molar volume of the ideal gas	L (STP) mol ⁻¹
$c_{(x)}$	Concentration of the respective index	%
m_{wv}	Mass of the water vapour in the biogas	g

The fed and withdrawn masses of volatile solids are utilised for the calculation of the VS decomposition.

$$VS_{\text{decomp}} = \frac{m_{\text{VS,inp}} - m_{\text{VS,dis}}}{m_{\text{VS,inp}}} \cdot 100 \quad 84$$

VS_{decomp}	VS decomposition	%
$m_{\text{VS,inp}}$	Mass of VS in the input (inlet)	g
$m_{\text{VS,dis}}$	Mass of VS in discharge	g

The correction of the TS content also has an impact here. Therefore, the volatile solids are corrected with the concentration of the volatile organic acids for the decomposition of the organic substance.

$$oS_{\text{decomp}} = \frac{(c_{\text{inp}} + m_{\text{VS,inp}}) - (c_{\text{dis}} + m_{\text{VS,dis}})}{(c_{\text{inp}} + m_{\text{VS,inp}})} \cdot 100 \quad 85$$

oS_{decomp}	Decomposition of the organic substance	%
----------------------	--	---

For the assessment of the deviations of parallel test, the data of the gas production of two digesters operated in parallel was utilised. In the test, the fermentation behaviour of renewable resources in the case of increasing organic loading rate was investigated. Fig. 7.4-4 shows the gas production and the organic loading rate. In comparison to this, Fig. 7.4-5 shows the cumulated gas production of the same test. The results of the gas production of the whole test period of 210 days ($n = 210$) were analysed. When comparing the average values of the production of gas of both reactors, a relative standard deviation of the daily gas production of 1.2% results.

The relative standard deviation of the daily gas production of the individual digesters is 6.2%, on average. For this, the values starting on the 126nd test day ($n = 84$) were utilised. This period is considered to be a stable state. If during a test significantly higher relative standard deviations occur here, a systematic error may be the reasons for that.

The quality of the continuous fermentation tests depends – in addition to the measuring errors of the measuring devices – essentially on a thorough and constant test support.

If the deviation of the average gas production of the single (or multiple) reference system(s) is to be assessed, statistical test methods must be utilised for this (e.g. Tukey Kramer).

7.5 Microbiological tests

Tobias Lienen¹, Patrick Schröder², Hilke Würdemann^{1,2}

¹Helmholtz Centre Potsdam German Research Centre for Geosciences · GFZ

²Hochschule Merseburg University of Applied Sciences

Status	The cultivation-independent molecular biology methods presented below are at the state of the art of science. Nevertheless, these methods are being optimised constantly and new high-throughput methods are being developed with which within an ever shorter period of time larger numbers of sample can be tested and characterised in even more detail.
Associated standards	The principle of the DGGE, qPCR and FISH is standardised. However, the protocols must be adjusted to the substrate mixtures to be tested. The methods are in application in a broad range.
Area of application	The methods can be applied to different substrate spectra. Limitations with respect to the meaningfulness of the test results exist insofar as a lot of the active microorganisms in biogas plants have not yet been sufficiently characterised. This makes the interpretation of the test results and the recommendation of countermeasures more difficult.
Need for research	Comparability to results of other methods: A short time ago, new high-throughput methods such as the Next Generation Sequencing (NGS) were established which allow for a qualitative and quantitative analysis of the sample in a single step and which make it possible to conduct comprehensive analyses at the same time. The affiliation of the microorganisms to specific functions, however, often is only insufficient since a lot of bacteria and archaea have not yet been cultivated and a physiological characterisation has not yet been performed. However, knowledge regarding the physiology and biochemistry of organisms is decisive in order to optimise biogas plants and to uncover the reasons for process disruptions. Therefore, in addition to cultivation-independent methods, cultivations of microorganisms occurring in plants as well as their characterisation are necessary. There still is a significant need for a correlation of chemical and biological process data for the enhancement of the understanding of the process with the objective of process optimisation, of improvement of the process stability, and of a performance increase.

The microbial composition and the number of cells of individual groups of microorganisms provide indications of the stability of the biogas production process and can provide indications of the causes of process disruptions. The four-stage biogas production process from hydrolysis via acidogenesis and acetogenesis to methanogenesis is carried out by

different microorganisms that must encounter optimal conditions in order to ensure a stable biogas process. The cultivation of individual microorganisms from an environmental sample is time-consuming and costly. To obtain data regarding the composition and number of the microorganisms rather quickly, molecular biology techniques can be used. This includes so-called "fingerprint" analyses such as the PCR-DGGE (polymerase chain reaction – denaturing gradient gel electrophoresis) and methods for quantification such as the fluorescence *in situ* hybridisation (FISH) or the quantitative polymerase chain reaction (qPCR). In addition to these three techniques which will be covered in more detail below, there are numerous other molecular biology methods to better examine the microorganisms (RITTMANN et al. 2008).

Polymerase chain reaction – denaturing gradient gel electrophoresis

The polymerase chain reaction – denaturing gradient gel electrophoresis (PCR-DGGE) serves for the molecular biology screening of an environmental sample such as the sample from a biogas reactor (LERM et al. 2012). At first, the whole DNA (deoxyribonucleic acid), that consists of a specific sequence of bases, is isolated from the sample. In this, different techniques can be used in which the cell lysis is based on different methods. For example, the cell lysis can be performed with heat, mechanically via small ceramic spheres, or via reagents. Often, commercially available DNA extraction kits, in which a defined protocol is followed, are used for this. Nevertheless, these protocols need to be optimised in most cases, depending on the type of sample and the microorganisms to be analysed (WEISS et al. 2007). In the polymerase chain reaction, a specific section of the overall DNA is amplified. This section is particularly well suited for the identification and the derivation of the capabilities of the organism found based thereupon.

The amplified DNA fragments are subsequently applied to a denaturing acrylamide gel. This gel contains a urea gradient which must be adjusted to the microorganisms to be analysed. The gel is connected to an electric field and due to the negative charge of the DNA molecules, these migrate in the gel in the direction of the plus pole. Depending on the sequence of bases of the DNA fragment, the double strand is denaturing more or less, and the further or the shorter the DNA travels in the denaturing gel. A banding pattern shows on the gel in which, in an ideal case, each band corresponds to one microorganism. The bands are sequenced and the microorganisms and/or their closest relatives can be identified via a comparison to a database freely accessible on the Internet (e.g. Basic Local Alignment Search Tool, BLAST). The affiliation helps in deriving the role of the different organisms in the digester and their significance for process stability.

Metagenomics based on Next Generation Sequencing approaches (NGS)

Nowadays classical fingerprinting techniques like the PCR-DGGE for analysing microbial communities in environmental samples are often replaced or extended by different metagenomic approaches. The aim of metagenomics is to analyze the metagenome, meaning the entire genetic information of a sample, instead of identifying only dominant organisms. These methods have in common that they are based on NGS technologies, which makes high throughput sequencing of DNA possible. The larger amount of data usually gives a more detailed picture of the composition and structure of microbial communities. Due to the complexity of those methods, various companies have specialized

in performing metagenomics, so the analysis can be easily commissioned. Similar to most of the molecular biological methods, first the genomic DNA needs to be isolated from the environmental sample. Special attention has to be paid to the quality and quantity of the DNA, especially with regards to shearing and purity. For best results in metagenomics, high molecular weight genomic DNA should be used as template, requiring an intensive adaptation of the DNA extraction method to the respective sample material. Subsequently, in case of PCR-directed metagenomics, a specific marker gene (mostly the prokaryotic 16S rRNA gene) is amplified via PCR.

The amplicons are then sequenced in high throughput using NGS. The hereby produced huge amounts of data are evaluated using bioinformatics. The marker gene sequences are compared with databases and assigned to taxonomic groups. Furthermore, detailed statistical analyses are possible due to the high amount of data. Another approach is followed in PCR-independent “shotgun”-metagenomics. The genomic DNA is broken down into small fragments via “shotgun” and the generated DNA fragments are sequenced directly in high-throughput using NGS. The biasing PCR step is eliminated. In the subsequent bioinformatical analysis, the sequenced DNA fragments are compared with genome databases and assigned to taxonomic groups. The big advantage of this method is that not only a specific marker gene is used for phylogenetic classification but the whole genetic information of the organisms. This allows also to estimate the physiological potential of a microbial biocenosis because the sequenced DNA fragments can be assigned to specific genes and thereby to potential functions. The disadvantage is that there are even less genome data for microorganisms available in the databases in comparison to specific marker gene data.

Quantitative PCR

The quantitative PCR (qPCR) relies on the same principle as the polymerase chain reaction mentioned above. Here, too, a specific section of the isolated DNA is amplified. In contrast to conventional PCR, in which only a semi-quantitative analysis is possible, the amplified DNA can be quantified in the qPCR so that the amount of DNA from specific microorganisms can be determined. For this, a fluorescent dye that binds to the DNA is added to the reaction. Alternatively, specific probes may also be used. The more DNA source material is available, the sooner the amplification can be detected so that a comparison in quantities becomes possible. In this, the quantification can be carried out absolute, with the help of an internal standard, or relative. In the case of relative quantification, the DNA amount of the target microorganism is put in relation to the DNA amount of the total bacterial or archaeal DNA. Herein, differences in the DNA extraction of several samples can also be relativized. The qPCR is very well suited to compare already characterised microorganisms of different samples in their quantity.

In addition to the DNA, RNA (ribonucleic acid) may also be analysed by means of qPCR. This can be meaningful if microorganisms can be detected in a sample, but there is no certainty whether these are metabolically active. The RNA is an evidence for the activity of organisms. Differences in the number and activity of microorganisms can be reasons and/or indications for process disruptions. A reduction in the activity of methanogenic organisms, for instance, is directly related to a lower biogas yield.

Fluorescence *in-situ* hybridisation

The fluorescence *in-situ* hybridisation (FISH) is a method for the determination of the number of metabolically active microorganisms. In this, a specific probe coupled with a fluorescent dye binds to a specific region on the genomic DNA or RNA molecules of microorganisms. Subsequently, the number of cells is determined with a fluorescence microscope. If the ribosomal RNA (rRNA) is chosen as target, primarily metabolically active cells are detected since the rRNA content correlates to the metabolic activity. With the help of specific probes for different physiological groups, the microbial biocenosis can be analysed in dependence of different process conditions. The detection of the activity is an important parameter for the assessment of biological processes since under disadvantageous conditions the activity changes much quicker than the number of cells. A lower cell division rate results from the decrease in the metabolic activity and quickly leads to a reduction in the number of cells due to eluviation processes in continuously operated reactors, such as in many biogas plants.

7.6 Culture based quantification of methanogenic reactor communities

Andreas Otto Wagner, Paul Illmer, University of Innsbruck, Institute of Microbiology

Status	Tried and tested in the scientific laboratory, method published: doi:10.1016/j.biombioe.2012.06.015
Associated standards	none
Area of application	Homogenous samples from liquid and dry fermentation processes (but also samples from other habitats like soil)
Disadvantages	As with every cultivation based approach, the choice of medium is crucial. Preparation of the medium requires microbiological expertise
Advantage	<ul style="list-style-type: none"> ● Cultivation based abundance evaluation using the product of the methane generation process of alive (re-cultivable) methanogens on a most probable number (MPN) basis. ● The physiological status of a methanogenic community is included in the evaluation to some extent. ● Discrimination between dead/inactive and alive/active methanogens. ● Information on physiological demands of methanogens by applying different incubation temperatures
Need for research:	–

Information on the abundance of methanogens can be an important issue for investigations on anaerobic digestion processes, e.g. on biogas reactor performance and stability. Although quantification of methanogenic communities by DNA-based methods is commonly applied, these methods strongly depend on an appropriate (tested and optimised for the respective matrix) DNA extraction procedure (e.g. KUHN et al. 2017) and can be limited by the lack of differentiation possibilities between (highly) active and dormant or alive and dead cells (WAGNER et al. 2008). However, also culture-based methods for abundance estimation can be biased by the choice of medium, cultivation conditions etc. Here – as a useful supplement to other, molecular-biological approaches – a culture-based method for the assessment of the abundance of methanogens is proposed. The method is based on serial dilution tests (BLODGETT 2010) in order to measure the concentration of target, i.e. methane-producing microbes. It can be adapted to various process conditions (psychro-, meso-, or thermophilic; hydrogenotrophic and/or acetoclastic methanogenesis) and is also applicable to other habitats containing methanogens (like soil etc.).

The principles of the presented method were published by WAGNER et al. (2012).

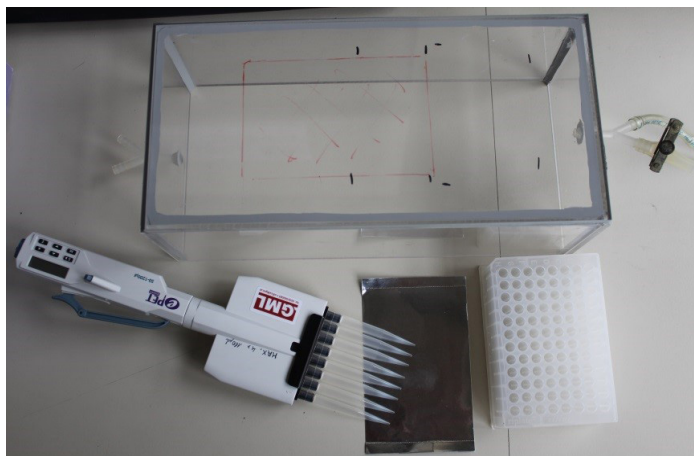

Figure 7.6-1: Multi-channel pipettor, aluminium foil, 96-well plate, and an example for a simple chamber with gas ports for flushing with nitrogen. By simply moving up the box during pipetting, excessive sample contact with oxygen is avoided. When dilution series is completed, the 96-well plate is sealed with the aluminium foil under the nitrogen stream

Sample preparation and media

Sample preparation

Approx. 500 g fresh sample is transferred to the laboratory as fast as possible, preferably cooled down immediately after drawing it. Transportation containers should be filled completely in order to avoid excessive contact with oxygen (be aware of possibly increased pressure within transportation containers when samples e.g. from anaerobic digestion systems are used!). In the lab, 450 mL of still hot, autoclaved distilled water is flushed with nitrogen gas during the cooling process in order to ensure oxygen-free conditions. Subsequently, 50 g of sample is added to achieve a dilution of 1:10. The flask is flushed with nitrogen gas to exchange the headspace again and closed with a butyl rubber septum (GL45, Ochs, Germany). Diluted samples are transferred to a shaker for 30 min (150 rpm, the temperature is selected according to the habitat under investigation).

Medium preparation

The evaluation of the number of methane-producing archaea is performed in 96-well plates (1 mL well volume) filled with autoclaved, oxygen-free methanogen medium (please refer to section Reagents). The medium (except sodium sulphide, vitamin and trace element solution and bicarbonate) is prepared in a standard screw-cap bottle (GL 45), autoclaved, during cooling down flushed with nitrogen gas, bicarbonate is added, and the flask closed with a butyl rubber septum. Sodium sulphide, vitamin and trace element solutions are added subsequently by syringe and cannula. These supplemental solutions can be stored for several months if kept cool in the dark.

Dilution series

Dilution series are prepared preferably in an anaerobic chamber (glove box) or under a permanent stream of nitrogen gas, which is a feasible low-cost alternative (WAGNER et al. 2012; Fig. 90). It has to be taken care for adequate room ventilation. Using a multi-channel pipettor, 180 μL of anoxic medium is filled into the wells of a 96-well plate avoiding excessive contact with air-oxygen. A total of 20 μL of diluted sample (as described above) is transferred into the first column of the plate and subsequently diluted 1:10 (from left to right) by gently mixing with the pipette and transferring 20 μL into the next column of wells. For each column, a new set of sterile pipette tips has to be used before mixing. According to particular requirements, the volume can also be upscaled. Plates are then sealed with self-adhesive aluminium foil and incubated at a temperature according to the habitat under investigation. It has to be taken care for exactly capping each well separately. For thermophilic conditions, a minimum of seven days, for mesophilic conditions 14 days, and for psychrophilic conditions a longer incubation time is recommended. In the headspace of each well, the gas produced by methanogenic activity accumulates and is subsequently analysed by gas chromatography using a flame-ionisation detector (GC-FID).

Analysis of headspace and MPN calculation

Analysis of headspace methane is carried out via GC-FID analysis by removing an appropriate amount (100 μL) of headspace gas from the sealed wells by simply piercing with a cannula and syringe. Exact determination of methane concentrations is not necessary. A sample (well) is considered positive when exceeding the ambient air methane concentration ten times indicating active methanogenic archaea within a certain well.

Calculation of most probable numbers (MPN) is done using tables for MPN calculations for eight tubes (e.g. BLODGETT 2010). For this purpose, the number of methane positive wells in three sequential columns is counted (positives per column), compared to an MPN table and calculated per gramm or millilitre of inoculum taking the effective dilutions into account.

Devices and materials

- gas chromatograph (GC-FID) for the detection of methane (CH_4) with a detection limit of approx. 1.5 ppm (standard GC-FID)
- single and/or multi-channel pipettors for transferring 180 μL and 20 μL incl. tips
- anaerobic chamber (glove box) or something similar
- compressed nitrogen flask for flushing purposes
- 96-well plates: total well volume of 1 mL
- self-adhesive aluminium foil
- syringes and cannules

Reagents

Medium

For modified DSMZ medium 119 (according to DSMZ - German Collection of Microorganisms and Cell Cultures):

- 0.50 g KH_2PO_4 , 0.40 g $\text{MgSO}_4 \times 7 \text{H}_2\text{O}$, 0.40 g NaCl, 0.40 g NH_4Cl , 0.05 g $\text{CaCl}_2 \times 2 \text{H}_2\text{O}$, 2 mg $\text{FeSO}_4 \times 7 \text{H}_2\text{O}$, 1.0 g yeast extract, 1.0 g sodium acetate, 2.0 g sodium formate, 0.20 g valeric acid, 0.20 g isovaleric acid, 0.20 g 2-methylbutyric acid, 0.20 g isobutyric acid, 0.50 g cysteine, 0.5 mL resazurin solution (0.1% (w/v)), 2 g NaHCO_3 ¹, 2 mL Na_2S solution, 1 mL vitamin solution, 1 mL trace element solution, 1000 mL distilled water, adjust to pH 7 using HCl or KOH.
- Na_2S solution²: 60 g $\text{Na}_2\text{S} \times 3 \text{H}_2\text{O}$, 200 mL distilled water. The solution is prepared in 200 mL serum flasks under nitrogen gas and autoclaved.
- Vitamin solution²: 10 mg cyanocobalamine, 10 mg p-aminobenzoic acid, 2 mg D(+)-biotin, 20 mg nicotinic acid, 5 mg Ca-D(+)-pantothenate, 50 mg pyridoxamine-dihydrochloride, and 36 mg thiamine-dihydrochloride dissolved in 200 mL distilled water. Prior to use the solution is filter-sterilised and stored in 200 mL serum flasks.
- Trace element solution²: 1.5 g $\text{FeCl}_2 \times 2 \text{H}_2\text{O}$, 70 mg ZnCl_2 , 100 mg $\text{MnCl}_2 \times 4 \text{H}_2\text{O}$, 190 mg $\text{CoCl}_2 \times 6 \text{H}_2\text{O}$, 2 mg $\text{CuCl}_2 \times 2 \text{H}_2\text{O}$, 24 mg $\text{NiCl}_2 \times 6 \text{H}_2\text{O}$, 36 mg $\text{Na}_2\text{MoO}_4 \times 2 \text{H}_2\text{O}$, 3 mg $\text{Na}_2\text{SeO}_3 \times 5 \text{H}_2\text{O}$, 4 mg $\text{Na}_2\text{WO}_4 \times 2 \text{H}_2\text{O}$, 6 mg H_3BO_3 , 10 mL 25% HCl, 990 mL distilled water. First FeCl_2 is dissolved in HCl, approx. 600 mL water is added before all ingredients follow. Subsequently the pH is adjusted to 7 using KOH and the solution is filled up to 1,000 mL. The solution is filter-sterilised prior to use.

Medium preparation

The medium (except sodium sulphide, vitamin solution, trace element solutions, and bicarbonate) is prepared in a standard screw-cap bottle (GL 45), autoclaved, during cooling down flushed with nitrogen gas, bicarbonate is added, and the flask closed with a butyl rubber septum. Sodium sulphide, vitamin and trace element solutions are added subsequently by syringe and cannula.

¹ Bicarbonate can also be added as a sterile solution. For this purpose, 50 mL distilled water (in a 200 mL flask) is flushed with CO_2 for at least 10 min. Then bicarbonate is added while flushing is continued for a few minutes. The flask is closed tightly and the solution is autoclaved. Be aware of an increased pressure, do not use fast cooling autoclaves, and put the flask into a plastic container (plastic beaker) while autoclaving! The volume of distilled water to be added to the medium has to be reduced by 50 mL.

² Can be stored cool in the dark for several months

Calibration

As a reference for GC-FID measurements, ambient air can be used (~ 2 ppm CH_4 , please refer to the latest reports on CH_4 concentration) or for calibration any commercially available calibration gas containing CH_4 in known concentration.

GC-FID parameters

Any GC-FID system can be used with the desired detection limit for methane. For evaluation purposes of the presented method, a very old GC PerkinElmer Sigma 3B Dual FID was used, equipped with a Porapak Q column (100/120 mesh), an oven temperature of 50°C , injector 100°C , and detector (FID) 120°C . As carrier gas, nitrogen (5.0) and for the FID flame, hydrogen (5.0) and compressed air were used. Gas samples were taken via a gastight syringe ($100\ \mu\text{L}$, Hamilton) and injected directly.

7.7 Differentiation of methanogenic pathways in biogas plants using compound-specific stable isotope analysis

Anko Fischer, Kevin Kuntze, Isodetect GmbH; Liane Müller, DBFZ; Hans-Hermann Richnow, Marcell Nikolausz, Helmholtz Centre for Environmental Research - UFZ

Status	The approach based on compound-specific stable isotope analysis (CSIA) has been compiled in numerous laboratory-scale biogas reactor studies (e.g. NIKOLAUSZ et al. 2013, LV et al. 2014, MULAT et al. 2016). Moreover, it has been applied successfully for biogas plants (e.g. POLAG et al. 2015). Thus, CSIA seems to be feasible for routine control of biogas plants. The method is practicable for monitoring the optimisation or adaptation of microbial processes in biogas plants.
Standard	Standards of the analytes with known stable isotope ratios should be measured for checking the accuracy of CSIA at regular intervals. If there are differences between the given values and measured isotope ratios of the standards, device-specific adjustments or corrections of the isotope data need to be accomplished.
Area of application	CSIA is suitable for the differentiation of methanogenic pathways in biogas plants (NIKOLAUSZ et al. 2013). Methanogenesis is the final step of the biogas production, which is most susceptible to interference. Hence, it is a good indicator for monitoring the process performance. Thereby, the shift in methanogenic pathways is an important parameter for process monitoring, since failures of biogas production are often accompanied by such shifts. Therefore, CSIA represents a monitoring tool for the prevention of process breakdown and process optimisation (LV et al. 2014, POLAG et al. 2015, MULAT et al. 2016).
Disadvantages	Both CSIA and interpretation of isotope data require specialists with knowledge in the field of environmental isotope chemistry. This is acceptable for monitor optimisation or adjustment measures of biogas plants. Though, the personnel expenditure would be relatively high for routine operations of biogas plants. Further developments should focus on the establishment of a system for the automatic measurement and interpretation of isotope data.
Advantages	The main advantage of CSIA compared to conventional process parameters (e.g. pH-value, FOS/TAC, volatile fatty acids, biogas composition) is that failures in biogas production can be detected earlier and more sensitive (LV et al. 2014, POLAG et al. 2015, MULAT et al. 2016). Thus, CSIA provides a basis for an early warning system of process failures in biogas plants (LV et al. 2014, POLAG et al. 2015). Another advantage of CSIA compared to conventional process parameters is that active methanogenic pathways and their relative contributions to methane formation are ascertainable (MULAT et al. 2016). The proportion of methanogenic pathways for biogas production during varying feeding regimes can be determined by $\delta^{13}\text{C}_{\text{CH}_4}$ - and $\delta^{13}\text{C}_{\text{CO}_2}$ -values (MULAT et al. 2016), indicating the potential of CSIA for optimisation of biogas processes.

Need for research:

The current results are a prerequisite for the derivation of algorithms to interpret isotope data for an automatic process monitoring of biogas plants. For this, a software tool needs to be developed for the ascertainment and evaluation of isotope data based on appropriate algorithms. The outcome of the software tool should be a generally understandable description for biogas-plant operators on the process status, for example as traffic light (green – process stable; yellow – potential risk due to process instability, potential need for action; red – high risk due to process instability, immediate need for action). Besides the software-based evaluation of isotope data, its ascertainment in sufficient measurement density is important in order to evaluate the process conditions in biogas plants reliably. Isotope ratio infrared spectroscopy (IRIS) allows online and precise CSIA at biogas plants (POLAG et al. 2015). Up to now, commercially available IRIS systems are relatively expensive for routine application of automatized CSIA. Compared to those, cheaper IRIS systems should be developed for CSIA at commercial biogas plants (KÄÄRIÄINEN et al. 2018).

Basics**Isotope ratio and δ -notation**

Isotopes of an element have the same number of protons (P) but vary in the number of neutrons (N), and have therefore different atomic masses (Fig. 7.7-1).

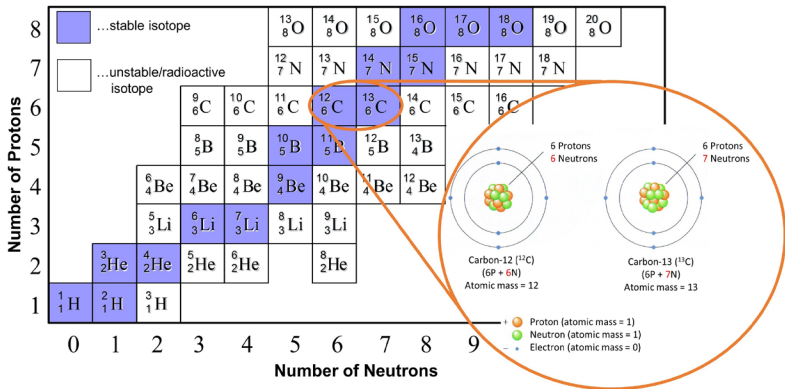

Figure 7.7-1: Overview on isotopes of chemical elements ranging from hydrogen to oxygen. The enlarged excerpt shows a simple atomic model of the two stable carbon isotopes with the derivation of their atomic masses based on the different numbers of neutrons. P - protons, N - neutrons

Organic molecules mainly consist of carbon and hydrogen. Both elements exhibit two stable isotopes. The quotient between the heavy and the light stable isotope is called isotope ratio or isotope signature (e.g. $^{13}\text{C}/^{12}\text{C}$, $^2\text{H}/^1\text{H}$), which is often expressed as delta notation (δ_{sample}) relative to an international standard according to Eq. 86 (COPLIN 2011).

$$\delta_{\text{sample}} = \frac{R_{\text{sample}}}{R_{\text{standard}}} - 1$$

86

- δ_{sample} Delta-value expression of stable isotope ratio (‰) or mUr
- R_{sample} Stable isotope ratio (e.g. $^{13}\text{C}/^{12}\text{C}$, $^2\text{H}/^1\text{H}$) of the sample
- R_{standard} Stable isotope ratio (e.g. $^{13}\text{C}/^{12}\text{C}$, $^2\text{H}/^1\text{H}$) of the international standard

For example, the delta notation of the stable carbon isotope ratio ($^{13}\text{C}/^{12}\text{C}$) is given as $\delta^{13}\text{C}$ -value with regard to the international standard V-PDB (Vienna-Pee Dee Belemnite, $^{13}\text{C}/^{12}\text{C} = 0.0111802$) (Fig. 7.7-2). Because variations in natural isotope abundance are typically small, δ -values are mostly reported in per mil (‰) or in mUr (milli Urey) (BRAND & COPLIN 2012).

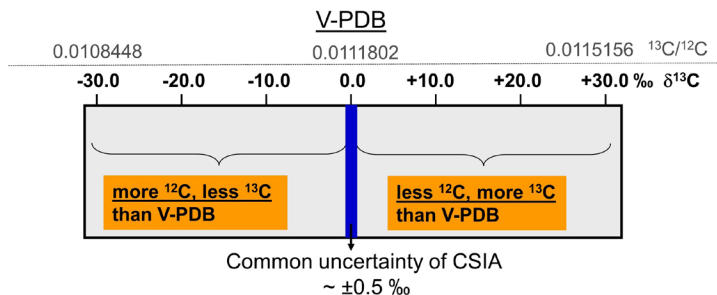

Figure 7.7-2: Illustration of the delta scale for stable carbon isotope ratios ($^{13}\text{C}/^{12}\text{C}$) as an excerpt ranging from -30 to +30 ‰. The anchor of the $\delta^{13}\text{C}$ -scale is V-PDB (Vienna-Pee Dee Belemnite, $^{13}\text{C}/^{12}\text{C} = 0.0111802$). CSIA - Compound-specific stable isotope analysis

Compound-specific stable isotope analysis (CSIA) of biogas

Biogas mainly consists of methane (CH_4) and carbon dioxide (CO_2) to approximately equal proportions. CSIA of CH_4 and CO_2 in biogas samples can be performed either by gas chromatography - isotope ratio mass spectrometry (GC-IRMS) or by isotope ratio infrared spectroscopy (IRIS) (KEPPLER et al. 2010).

A common approach for the measurement of carbon isotope ratios of CH_4 ($\delta^{13}\text{C}_{\text{CH}_4}$ -values) and CO_2 ($\delta^{13}\text{C}_{\text{CO}_2}$ -values) in gas samples is gas chromatography - combustion - isotope ratio mass spectrometry (GC-C-IRMS) (YARNES 2013). In the gas chromatograph, CH_4 and CO_2 are chromatographically separated using an appropriate GC-column (e.g. PoraBOND Q) and temperature programme (e.g. 35 °C isothermal) (Fig. 7.7-3). Afterwards, they pass through a combustion oven where CH_4 is converted to CO_2 and CO_2 remains unchanged. Then, the time-resolved CO_2 equivalents enter the isotope ratio mass spectrometer, where they are ionised and separated according to their isotopic masses (44 - $^{12}\text{C}^{16}\text{O}_2$, 45 - $^{13}\text{C}^{16}\text{O}_2$, 46 - $^{12}\text{C}^{16}\text{O}^{18}\text{O}$ for correction of $^{12}\text{C}^{16}\text{O}^{17}\text{O}$ regarding mass 45). The amounts of isotopic masses for the CO_2 equivalents are detected in Faraday cups and used for calculation of $\delta^{13}\text{C}$ -values.

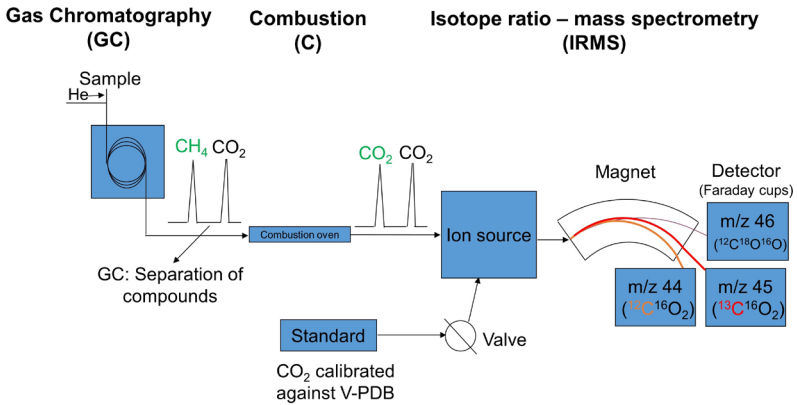

Figure 7.7-3: Scheme of gas chromatography - combustion - isotope ratio mass spectrometry (GC-C-IRMS) for CSIA of carbon for CH_4 and CO_2

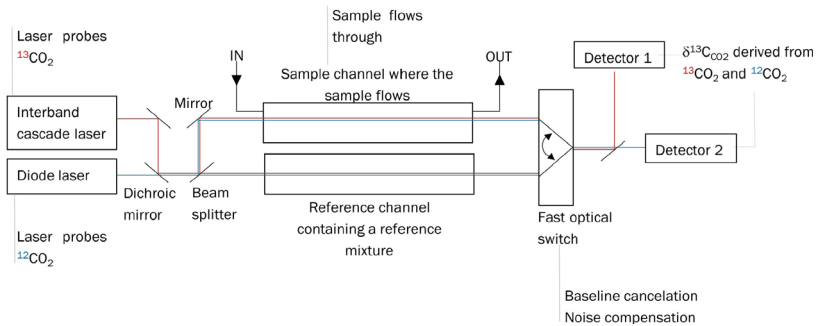

Figure 7.7-4: Scheme of an example of an IRIS system for CSIA of CO_2

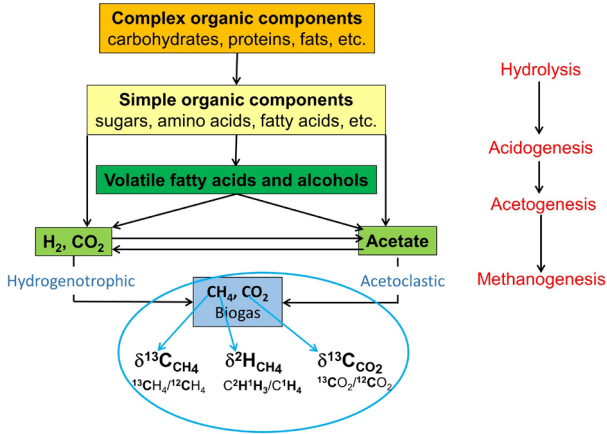

Figure 7.7-5: Pathways of biogas formation and concept for differentiation of methanogenic pathways in biogas plants using CSIA

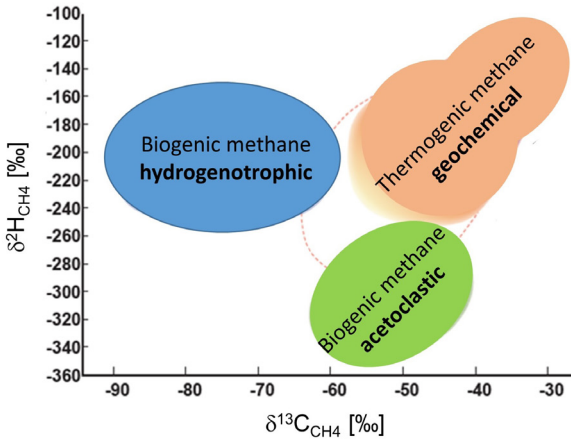

Figure 7.7-6: Differentiation of methanogenic pathways using the comparison of $\delta^{13}C_{CH_4}$ - and $\delta^2H_{CH_4}$ -values. Modified from CHANTON et al. (2005)

In analogy to GC-C-IRMS, the determination for hydrogen isotope ratios of CH₄ ($\delta^2\text{H}_{\text{CH}_4}$ -values) can be performed by gas chromatography - pyrolysis - isotope ratio mass spectrometry (GC-P-IRMS) (YARNES 2013). After chromatographic separation, analytes are time-resolved and converted to molecular hydrogen (H₂), which serves as measuring gas for the determination of $\delta^2\text{H}$ -values based on isotopic masses 2 (¹H₂) and 3 (²H₂).

The measurement of $\delta^{13}\text{C}_{\text{CH}_4}$ - and $\delta^{13}\text{C}_{\text{CO}_2}$ -values in gas samples is also possible using IRIS (McMANUS et al. 2002). Molecules have absorption lines at specific wavelengths due to the quantum mechanical rotational and vibrational states. The changes in the rotational motions of the molecule that accompany the absorption or emission of an infrared photon give rise to the fine structure observed at sufficiently low pressure and high instrumental resolution. The resulting spectra are highly sensitive to different isotope compositions of the molecule (e.g. ¹³C¹H₄ vs. ¹²C¹H₄, ¹³C¹⁶O₂ vs. ¹²C¹⁶O₂). This can be exploited by measuring the intensity decrease of a laser beam that has traversed several meters through a gas as a function of the laser wavelength (Fig. 7.7-4). At wavelengths, for which the laser radiation is in resonance with a molecular rotation-vibration transition, an absorption feature will be registered that can be uniquely assigned to one of the isotopic compositions of the molecule. The Beer-Lambert law relates the laser intensity loss due to the molecular absorption to the molecular number density. In this way, by recording two spectra, one belonging to the sample, one to a known reference material, the $\delta^{13}\text{C}_{\text{CH}_4}$ - and $\delta^{13}\text{C}_{\text{CO}_2}$ -values can be determined. Besides carbon isotope analysis, $\delta^2\text{H}_{\text{CH}_4}$ -values can also be determined by IRIS (KÄÄRIÄINEN et al. 2018).

An advantage of IRIS is the capability of performing continuous measurements with sensitivities comparable to the state-of-the-art laboratory-based GC-IRMS, but on-site in real-time. Such performance is essential for reliable flux analysis.

Isotope ratios of methanogenic pathways

Biogas substrates are complex organic compounds, which are converted by various microorganisms via several degradation steps to CH₄ and CO₂ (Fig. 7.7-5). The main pathways of methanogenesis rely on the conversion of acetate (acetoclastic: CH₃COOH → CH₄ + CO₂) or H₂ and CO₂ (hydrogenotrophic: CO₂ + 4 H₂ → CH₄ + 2 H₂O), (Fig. 7.7-5). An important parameter for monitoring the process stability in biogas plants is the ratio between the two main methanogenic pathways (acetoclastic vs. hydrogenotrophic), since it is sensitive to biogas substrate and process conditions. Changes in the ratio of acetoclastic and hydrogenotrophic methanogenesis might indicate transition states or disturbances in the anaerobic digestion process. Therefore, they are suitable as early warning of process failure. Methods for differentiating methanogenic pathways (acetoclastic vs. hydrogenotrophic) are rarely established or time-consuming. Hence, information is often missing for optimisation of the biogas production and for early detection of failures in biogas plants. For this purpose, appropriate analytical tools are needed in order to monitor methanogenic pathways precisely and promptly.

Isotopes of an element have the same electron shell (Fig. 7.7-1). Thus, they do not differ in their kind of possible reactions but in their reaction kinetics, because those are among others mass-dependent. For this reason, stable isotope ratios of a substrate or a product can change to different extents depending on various reaction mechanisms of a biochemical process (e.g. methanogenesis via acetoclastic or hydrogenotrophic pathway), which provides the potential to differentiate degradation or formation pathways in complex systems using CSIA.

Methanogenic pathways can be distinguished by the comparison of $\delta^{13}\text{C}_{\text{CH}_4}$ - and $\delta^2\text{H}_{\text{CH}_4}$ -values (Fig. 7.7-6) as well as of $\delta^{13}\text{C}_{\text{CH}_4}$ - and $\delta^{13}\text{C}_{\text{CO}_2}$ -values (Fig. 7.7-7) (CHANTON et al. 2005, WHITICAR 1999). Recent studies validated that those basics can be applied to methanogenesis in biogas plants (NIKOLAUSZ et al. 2013, LV et al. 2014, POLAG et al. 2015, MULAT et al. 2016).

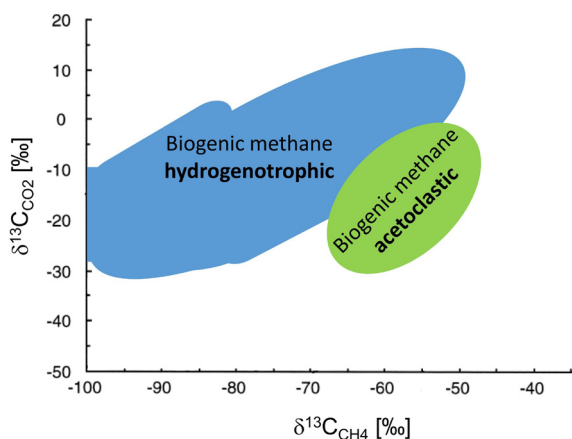

Figure 7.7-7: Differentiation of methanogenic pathways using the comparison of $\delta^{13}\text{C}_{\text{CH}_4}$ - and $\delta^{13}\text{C}_{\text{CO}_2}$ -values. Modified from WHITICAR (1999)

Process control of biogas production based on CSIA

Based on CSIA, changes in the main methanogenic pathways (acetoclastic vs. hydrogenotrophic) are sensitively and promptly detectable during biogas production. NIKOLAUSZ et al. (2013) showed that variations in the extent of acetoclastic and hydrogenotrophic methanogenesis in biogas reactors can be monitored by the comparison of $\delta^{13}\text{C}_{\text{CH}_4}$ - and $\delta^2\text{H}_{\text{CH}_4}$ -values. For experiments with chicken manure and dried distillers grains with solubles (DDGS), which exhibited carbon isotope ratios in the range of those of C3-plants (-30 to -20 ‰), the proportion of methanogenic pathways ascertained by the comparison of $\delta^{13}\text{C}_{\text{CH}_4}$ - and $\delta^2\text{H}_{\text{CH}_4}$ -values was in accordance with the pattern of methanogenic microorganisms (Fig. 7.7-8). Contradictory results for the identification of methanogenic pathways were observed for the biogas reactor with maize silage; while the pattern of methanogenic microorganisms pointed to hydrogenotrophic methanogenesis, the comparison of $\delta^{13}\text{C}_{\text{CH}_4}$ - and $\delta^2\text{H}_{\text{CH}_4}$ -values indicated acetoclastic methanogenesis (Fig. 7.7-8). It was obvious, that

the conversion of maize silage with a less negative carbon isotope ratio (-12.6‰), which is typical for C4-plants (-15 to -10‰), led to the formation of methane with also less negative $\delta^{13}\text{C}_{\text{CH}_4}$ -values and, thus, influenced the assessment of methanogenic pathways. Hence, the variability of isotope ratios for biogas substrates should be taken into account for the evaluation of methanogenesis in biogas plants.

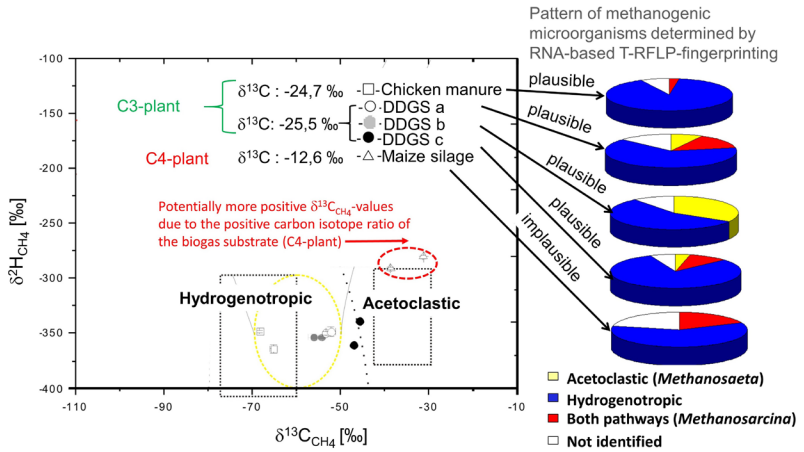

Figure 7.7-8: $\delta^{13}\text{C}_{\text{CH}_4}$ - and $\delta^2\text{H}_{\text{CH}_4}$ -values as well as pattern of methanogenic microorganisms for biogas reactor experiments with chicken manure, dried distillers grains with solubles (DDGS) and maize silage. Modified from NIKOLAUSZ et al. (2013)

Recent studies indicated that CSIA is an appropriate monitoring tool for process stability and optimisation (Lv et al. 2014, POLAG et al. 2015, MULAT et al. 2016). In biogas reactors, $\delta^{13}\text{C}_{\text{CH}_4}$ -values shifted significantly during the inhibition of biogas production due to increasing ammonium concentration (Fig. 7.7-9, Lv et al. 2014) and organic loading rate (ORL) (POLAG et al. 2015), before this could be observed by conventional process parameters. Thus, CSIA provides basics of an early warning system for ascertaining process failures in biogas plants.

The relative contribution of methanogenic pathways to biogas production during varying feeding regimes could be determined by $\delta^{13}\text{C}_{\text{CH}_4}$ - and $\delta^{13}\text{C}_{\text{CO}_2}$ -values (Fig. 7.7-10). Based on the findings of MULAT et al. (2016), CSIA is a reliable monitoring tool for the optimisation of biogas processes.

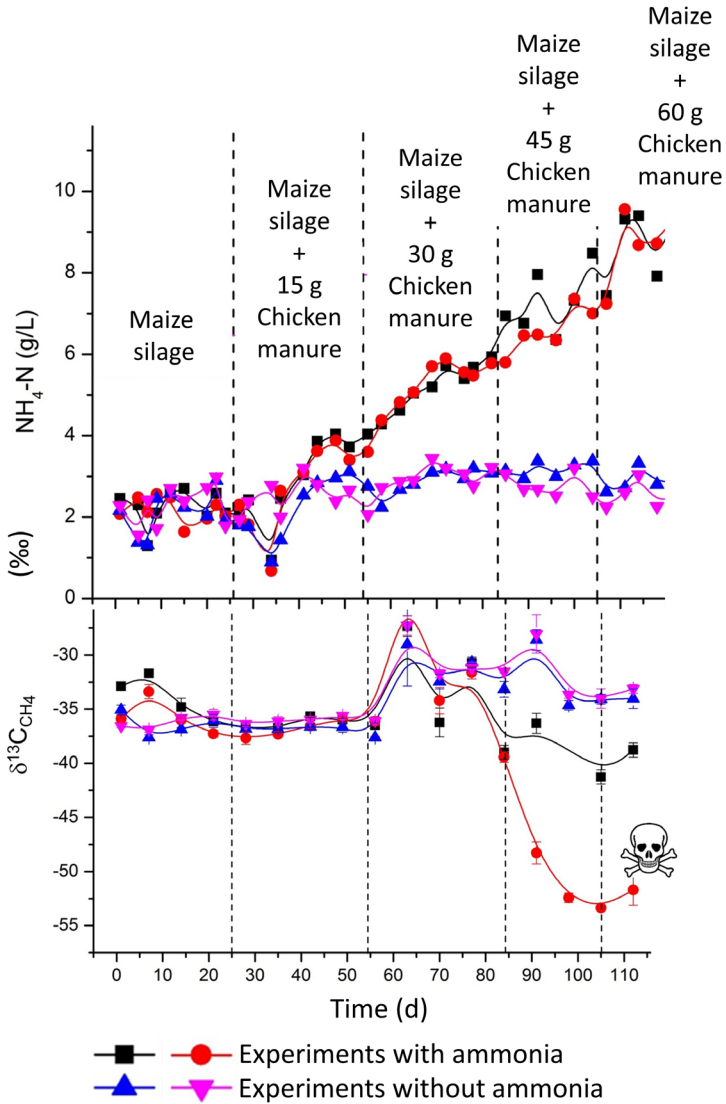

Figure 7.9-9: Changes in $\delta^{13}\text{C}_{\text{CH}_4}$ values due to the inhibition of biogas production caused by increasing ammonium concentration ($\text{NH}_4\text{-N}$). Modified from Lv et al. (2014)

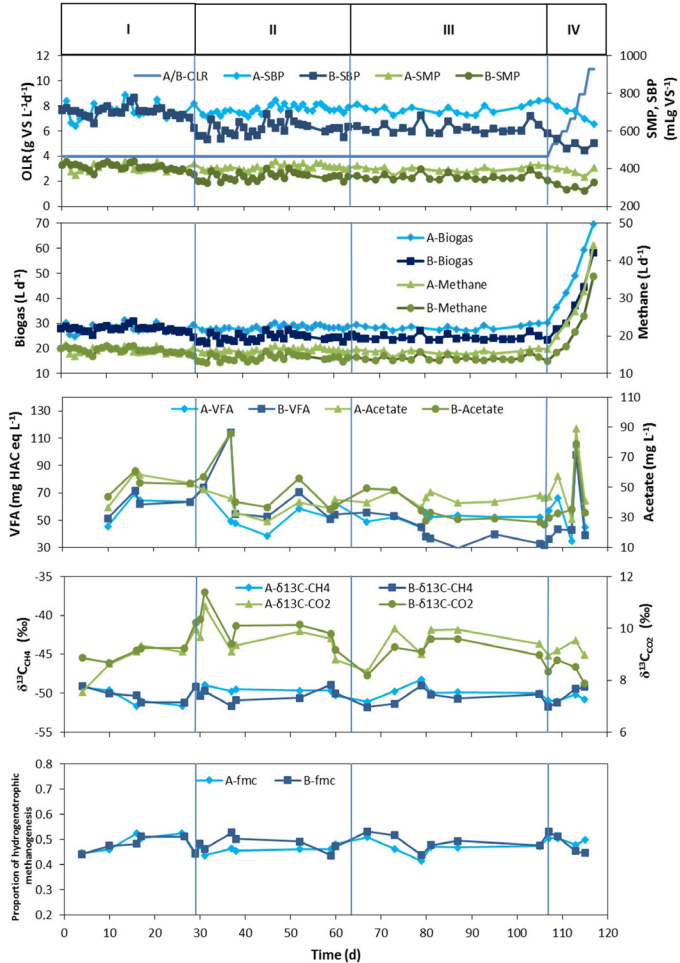

Figure 7.7-10: Organic loading rate (OLR), biogas and methane production, concentration of volatile fatty acids (VFA) and acetate, $\delta^{13}\text{C}_{\text{CH}_4}$ - and $\delta^{13}\text{C}_{\text{CO}_2}$ -values as well as proportion of hydrogenotrophic methanogenesis derived from carbon isotope data for a long-term experiment with two biogas reactors (A, B) using DGGs as biogas substrate operated with varying feeding regimes:

Phase I (Day 1–29): Reactor A and B with daily substrate feeding and OLR of 4 g volatile solids (VS) per litre and day;

Phase II (Day 30–63): Reactor A with daily substrate feeding and OLR of 4 g VS per litre and day as well as reactor B with substrate feeding every two hours and OLR of 4 g VS per litre and day;

Phase III (Day 64–107): Reactor A with substrate feeding every two days and OLR of 4 g VS per litre and day as well as reactor B with substrate feeding every two hours and OLR of 4 g VS per litre and day;

Phase IV (Day 108–118): Reactor A with a substrate feeding every two days and OLR of 5–11 g VS per litre and day as well as reactor B with substrate feeding every two hours and OLR of 5–11 g VS per litre and day.

SMP - specific methane production, SBP - specific biogas production, HAC eq - acetic acid equivalent of all VFAs.

Modified from MULAT et al. (2016)

Practical aspects

For CSIA, biogas samples should be taken directly from the headspace of the digester unit of the biogas plant. If this is not possible, digestate should be sampled and transferred into appropriate flasks for obtaining biogas.

According to the kind of samples (biogas vs. digestate), different CSIA methods should be applied. In case of the availability of biogas via a bypass of the digester unit of the biogas plant, a direct measurement using IRIS is recommended, since a continuous and online determination of isotope data is possible (POLAG et al. 2015). If only digestate is available, it is suggested that the measurement of stable isotope ratios for CH₄ and CO₂ is performed by GC-IRMS. For CSIA of biogas in flasks with digestate, this method is simpler and needs less technical effort than IRIS.

The estimation of isotope ratios should be initiated during or immediately after the measurement. Thus, a prompt evaluation of the process status of an investigated biogas plant can be assured. For this, variations of stable isotope ratios of biogas substrates for the interpretation of $\delta^{13}\text{C}_{\text{CH}_4}$ - and $\delta^{13}\text{C}_{\text{CO}_2}$ -values (Eq. 87 and 88) as well as variations due to the type of substrate supply (quasi-continuous vs. discontinuous) need to be taken into account.

$$\Delta^{13}\text{C}_{\text{CH}_4} = \delta^{13}\text{C}_{\text{CH}_4} - \delta^{13}\text{C}_{\text{Substrat}} \quad 87$$

$$\Delta^{13}\text{C}_{\text{CO}_2} = \delta^{13}\text{C}_{\text{CO}_2} - \delta^{13}\text{C}_{\text{Substrat}} \quad 88$$

$\Delta^{13}\text{C}_{\text{CH}_4}$	Carbon isotope discrimination of methane against biogas substrate	‰ or mUr
$\Delta^{13}\text{C}_{\text{CO}_2}$	Carbon isotope discrimination of carbon dioxide against biogas substrate	‰ or mUr
$\delta^{13}\text{C}_{\text{CH}_4}$	Carbon isotope ratio of methane given as delta notation	‰ or mUr
$\delta^{13}\text{C}_{\text{CO}_2}$	Carbon isotope ratio of carbon dioxide given as delta notation	‰ or mUr
$\delta^{13}\text{C}_{\text{Substrate}}$	Carbon isotope ratio of biogas substrate given as delta notation	‰ or mUr

For quasi-continuous substrate supply, differences of $\Delta^{13}\text{C} > \pm 5\%$ from average $\Delta^{13}\text{C}$ provide indications of failures for biogas production. Since larger variations in the daily course of stable isotope ratios of the biogas occur for discontinuous substrate supply, a less sensitive ascertainment ($\Delta^{13}\text{C} > \pm 10\%$ from average $\Delta^{13}\text{C}$) of potential failures is possible compared to quasi-continuous substrate supply.

8 Batch tests

8.1 Inter-Laboratory Test: KTBL/VDLUFA-Proficiency Test Biogas

*Mark Paterson, Association for Technology and Structures in Agriculture; Hans Oechsner, University of Hohenheim;
Peter Tillmann, VDLUFA Quality Assurance NIRS GmbH*

Test requirements/ Test procedure

The basic requirement for the proficiency test participation is the compliance with the VDLUFA method "Determination of biogas and methane yield in fermentation tests" (VDLUFA 2011), VDI GUIDELINE "Fermentation of organic substances; substrate characterisation, sampling, collection of material data, fermentation tests" 4630 (VDI 2016) for the analysis scope biogas and methane yield so as VDI GUIDELINE 4630 and "Determination of the residual gas potential from fermentation residues in laboratory tests" (VDLUFA 2019) for the residual methane potential.

At least three different samples are sent for the fermentation test and two for the residual methane potential determination. For this purpose, identical sample material are sent to all laboratories in the quantity required for the individual test setup.

The sample material should be handled and analysed in the laboratory as usual.

There is no system limit for participation.

The evaluation of the inter-laboratory test is anonymous.

Substrate used

At least three different samples are sent for the fermentation test in the inter-laboratory test (samples changes every year). The sample material contains:

- microcrystalline cellulose (as reference substrate)
- maize silage as a typical test material
- other fermentation substrates which should cover the usual range of substrate variations, like wheat grain, grass silage, cup plant, oat bran, forage and brewer's grains

The raw nutrients are usually determined in maize silage samples. The analysis of the residual methane potential is based on fermentation residue (digestate) samples from an agricultural biogas plant.

Result interpretation

The evaluation is carried out according to DIN standard No. 5725 "Accuracy (correctness and precision) of measuring methods and results" (DIN 1997 and DIN 2002), in order to describe the performance of the analysis method, and DIN standard No. 38402-45 "Standard methods for water, wastewater and sludge analysis - Part 45: inter-laboratory tests for suitability testing of laboratories" (DIN 2014).

Result interpretation	<p>Since 2015, the proficiency test exclusively pursues the approach of improving the laboratories work (proficiency test type Q – no plausibility check of the transmitted values). After test completion, the participating laboratories receive a seal of quality for their “successful” participation. This certificate refers to the correct determination of gas yields and is issued, if</p> <ul style="list-style-type: none"> ● all major samples have been analysed, ● the standardised normal distribution from 2 of 3 samples is at maximum of ± 2 and ● the target biogas or methane yield of the cellulose has been determined according to the VDLUFA method.
Key statements from the tests	<p>Proficiency tests play a central role in quality monitoring in laboratories, as they offer laboratories the opportunity to test and objectively demonstrate their performance in comparison with other laboratories.</p> <p>The international KTBL/VDLUFA-Proficiency Test Biogas provides an comprehensive quality-assurance for biogas laboratories for the determination of gas yield and residual methane potential. Herewith the participants are able to identify causes of deviations in the measurement and to minimize analysis errors. This increases the accuracy of the biogas laboratories and the quality of the laboratory results.</p>

For the design and operational optimisation of anaerobic digestion plants, data on the specific methane yield of fermentation substrates used from fermentation tests are generally used together with information and experience from existing biogas plants (e.g. type of fermentation substrates used, organic loading rate, hydraulic retention time, substrate structure, nutrient composition requirements, etc.). Standard values for biogas yield (KTBL 2015 and KTBL 2013) are often used for estimating the specific methane yield of the substrates used which represent a compilation of the results of experienced laboratories. If exact data for special substrates are required, laboratories specialised in such investigations can be commissioned for a fermentation test.

In practice, it has been shown that the results obtained in this way do not always match the methane yield, and in some cases, even considerable deviations become apparent. This is partly because the laboratories use different approaches for the investigation or deviate from the already developed methods/guidelines taking into account the special requirements. The VDI GUIDELINE 4630 is particularly relevant for this, which was developed for discontinuous and continuous tests in 2006 and was revised in 2016. Together with the KTBL working group “Proficiency Test Biogas Yields”, the VDLUFA has developed a methodical guideline for the procedure in discontinuous experiments for the determination of the methane yield of organic substrates based on the VDI GUIDELINE mentioned (VDLUFA 2011). Both methodological regulations serve as a basis for the performance of fermentation tests in the laboratory.

Despite the established methodological regulations, the results of discontinuous fermentation tests (batch tests) often deviate from each other, even with apparently small deviations from the method specifications. In order to achieve a systematic and laboratorywide quality improvement of the biogas laboratories in determining gas yields, the German Association for Technology and Structures in Agriculture (Kuratorium für Technik und Bauwesen in der Landwirtschaft e.V. - KTBL) together with VDLUFA Quality Assurance NIRS GmbH (VDLUFA Qualitätssicherung NIRS GmbH) carry out an inter-laboratory test on an annual basis. This allows identifying the basis behind the deviations between participating laboratories and detecting and eliminating possible errors.

Objectives of the Proficiency Test Biogas

Proficiency tests play a central role in quality monitoring of laboratories, as they offer laboratories the opportunity to test and objectively demonstrate their performance. This is because the actual analytical performance of a laboratory can best be tested in comparison with other laboratories. For this purpose, the participating laboratories receive identical samples at the same time, which they analyse according to uniform methods and as is customary in the respective laboratory. Based on the subsequent round robin test evaluation, statements can be made about the measuring accuracy and quality of the laboratories. The participation at a proficiency test is a quality assuring measure to the laboratory and an confidence-building action to the authorities.

The aim of the KTBL/VDLUFA-Proficiency Test Biogas is essentially a comprehensive quality-assurance of biogas laboratories in the determination of gas yield and residual methane potential by means of discontinuous laboratory tests (batch tests). To this end, possible influencing factors and causes of deviations in the measurement results are analysed in order to increase the measurement accuracy of the biogas laboratories. This improves the comparability of the results of fermentation tests. With the reduction of analysis errors and the associated improvement of data quality, the reliability of the data basis for the KTBL standard values for biogas yield (KTBL 2015 and KTBL 2013) and the acceptance of the standard values in practice increases.

The Proficiency Test Biogas of KTBL and VDLUFA also exists to examine the VDLUFA Association Method (VDLUFA 2011), which initially enabled the plausibility check of the submitted laboratory data (round robin test type M). Since 2015, the Proficiency Test exclusively pursues the approach of improving the laboratories work (round robin test type Q), for which a quality seal on successful participation is been issued (see Fig. 8.1-5).

However, the changed approach towards the round robin test type Q with the absence of the plausibility check by the organiser can be seen in the course of the repeatability and-comparability coefficients of variation (see Fig. 8.1-3 and Fig. 8.1-4).

Development/history of the Proficiency Test Biogas

Between 2006 and 2008, the proficiency tests for gas yields from biogas substrates was carried out by KTBL and VDLUFA for the first time, as part of a project funded by the Federal Ministry of Food and Agriculture. With help of these inter-laboratory tests differences in the test results of fermentation tests, which were carried out based on VDI GUIDELINE 4630 of 2006, have been systematically identified and deviations have been reduced for the first time (NARABI 2010). At that time, the KTBL working group “Proficiency Test Biogas Yields” was founded, which has accompanied the inter-laboratory tests since then and provides practical support for the discussion of errors

In 2011, the KTBL and VDLUFA decided to continue organising the inter-laboratory test biogas on their own - without any project funding - which was already established at the laboratories in the biogas sector. Therefore, it was decided to carry out the test regularly every 18 months. However, only two years later, the demand among (accredited) biogas laboratories for a continuous quality-assurance measure had increased significantly, resulting in the biogas inter-laboratory test being offered once a year since 2014, due to its good reputation in the industry.

Against the background of the increasing relevance of determining the residual methane potential e.g. for efficiency evaluation of existing biogas plants, it was decided to include the residual gas determination of digestates in the analysis spectrum of the proficiency test. During the first evaluations of the proficiency test with regard to the determination of residual methane it turned out that numerous biogas laboratories had considerable potential for optimisation when determining this parameter. This is similar to the results at the beginning of the proficiency test for biogas yield measurements.

Since then, the scope of analysis of the proficiency test can be determined individually by each participating laboratory. The participants choose from the scope of analysis fermentation test (determination of the biogas and methane yield including the methane content), raw nutrients (e.g. crude protein, crude fibre, crude fat) and/or the determination of the residual methane potential (at 20 °C and 37 °C).

The number of participating laboratories is between 20 and 30 per year, which come from Germany and abroad and participate with different experimental setups. Looking at the selected analysis scopes of the last three years, the focus in determining the gas yield (Ø 24 laboratories per test) and determining the residual gas potential (Ø 17 laboratories per test) is clear (WEINRICH AND PATERSON 2017).

Methodological requirements for implementation

In order to obtain a uniform procedure and a good basis for the comparison of the test results from the biogas round robin test, the VDI GUIDELINE 4630 (VDI 2016) or the VDLUFA Association Method (VDLUFA 2011) is specified.

The VDI GUIDELINE 4630 was issued in order to adapt a method for determining the methane yield for biogas plants due to the increasing utilisation of dry matter rich biomass such as renewable raw materials as substrates (OECHSNER AND PATERSON 2013). The guideline is more likely suitable for these substrates and probably provides more meaningful results than the previously known DIN 38414, which was designed for the analysis with substrates low in dry matter content (such as sewage sludge).

The findings from these first KTBL/VDLUFA inter-laboratory tests led to the development of method specifications for biogas yield measurement by the KTBL working group, which was adopted by the VDLUFA as Association Method "Determination of biogas and methane yield in fermentation tests" (VDLUFA 2011). The Association Method serves to simplify the implementation of VDI GUIDELINE 4630 (VDI 2016) and thus contributes to avoiding sources of error during fermentation tests.

This includes the following focal points:

- The sample is anaerobically degraded under standardised conditions with an inoculum in a laboratory digester (volume from 100 mL to 15 L) under controlled temperature conditions in mesophilic range (37 ± 2 °C). As a result, the specific biogas or methane yield per kilogram of added volatile solids (VS) is determined. Temperature-controlled small fermenters are used as test apparatus.
- Biologically active material from a biogas plant (preferably a mixture of several plants), a pilot fermenter and/or digestion tower is used as inoculum. It can also be cultivated if necessary. The volatile solids content should be between 1 and 3% by weight and at least 50% of the total solids content (TS). The acetic acid equivalent < 500 mg L⁻¹. It should have a low gas formation potential. The inoculum's own methane production should be less than 20% of the methane production of the test substrate to improve measurement accuracy and to avoid excessive synergy effects of the inoculum. If this is not the case with the original material, it can be decomposed at a controlled temperature; deviations from the inocula are permissible if comparable results can be demonstrated.
- The sample quantity to be weighed is reduced to a particle size of < 10 mm. Grains such as grain or oilseeds are squeezed or crushed. The mass of TS (drying at 105 °C to constant weight) and VS (ashing at 550 °C to constant weight) are determined for each sample and inoculum. The inoculum's pH value has to be determined too. The volatile solids mass of the sample to be weighed must not exceed 50% of the organic dry matter mass of the added inoculum. The total solids of the mixture of inoculum and sample in the fermenter must not exceed 10% of the total mass. The mixing ratio of inoculum and test substrate should be above 2:1 in relation to volatile solids in order to ensure sufficient buffer capacity and optimal nutrient supply of the bacteria. This mixing ratio should ensure that the inoculum is not overloaded, especially in the endangered initial phase of the batch test. Excessive acid formation causes process inhibition and would falsify the result of the test.

- A reference material is to be co-fermented. For this purpose, microcrystalline cellulose must be used, possibly with an in-house standard substrate. The target value of the biogas yield (cell structure of methane bacteria taken into account) of microcrystalline cellulose is 745 IN kg⁻¹ VS on average and should be at least 90% and max. 110%.
- Each of the samples, including the inoculum, is analysed in 3 repetitions (at least 2 repetitions). The gas volume formed is determined as frequently as possible, as is the methane content in the biogas. The measured gas quantities are referred to standard litres (STP) for each measuring interval.
- The duration of the fermentation test is at least 25 days. The measurement can also be completed if the quantity of gas formed on at least 3 consecutive days is less than 0.5% of the cumulative gas quantity formed from the beginning of the test. The gas measuring apparatus must be designed in such a way, that no gas component is dissolved in a barrier liquid. The amount of biogas formed must be corrected by a water vapour correction.

So far, the residual methane potential has been determined according to the methods mentioned for determining the gas yield. However, special requirements must be observed for practical test results, e.g. the determination of the residual methane potential is basically carried out without the addition of inoculant material to the sample or other substrates and auxiliaries and at the individual operating process temperature. These had to be adapted especially for the test setups. The requirements for a standardised and comparable test approach are described in VDI GUIDELINE 4630 (VDI 2016) and in the new method specification "Determination of the residual gas potential from fermentation residues in laboratory tests" (VDLUFA 2019). Both methods serve as a basic requirement for participation in the round robin test biogas.

Methodology

Performance of the Proficiency Test Biogas

The scope of the annual KTBL/VDLUFA inter-laboratory test biogas is determined individually by the participating biogas laboratories. The participants choose from the following analysis scopes:

- determination of the biogas and methane yield for at least 3 sample materials, including determination of dry matter, organic dry matter, crude ash and fermentation acids,
- determination of raw nutrients: crude protein, crude fibre, crude fat, crude starch, sugar and other characteristics of feed evaluation and/or
- determination of the residual methane potential (at 20 °C and 37 °C), including the determination of C2–C5 fatty acids

The following description mainly refers to the analysis scope "fermentation test" (determination of biogas and methane yield) and "residual methane potential". The focus of the present investigation is on the methane yield determination only.

The basic requirement for the proficiency test participation is the compliance with the VDLUFA method "Determination of biogas and methane yield in fermentation tests" (VDLUFA 2011) or the VDI GUIDELINE "Fermentation of organic substances; substrate characterisation, sampling, collection of material data, fermentation tests" 4630 (VDI 2016) for the analysis scope biogas and methane yield. For the residual methane potential determination the requirement of guidelines VDI (2016) and VDLUFA (2019) are obligatory.

At least three different samples are sent for the fermentation test in the round robin test. For this purpose, identical sample material are sent to all laboratories in the quantity required for the respective test setup. The sample material should be handled and analysed in the laboratory as usual. The sample material contains microcrystalline cellulose as reference substrate and maize silage. The other fermentation substrates shipped should cover the usual range of substrate variations in practice. Other throughput substrates included wheat grain, grass silage, cup plant, oat bran, forage and brewer's grains. The raw nutrients are usually determined in maize silage samples. The analysis of the residual methane potential is based on fermentation residue (digestate) samples from a single agricultural biogas plant. When sending fresh silages, the influence of sample storage and sample homogenisation on the result is also possible (OECHSNER AND PATERSON 2013). Normally, the samples are therefore sent in insulated boxes in the cooled state in an express parcel.

All samples, including the inoculum, must be analysed by the laboratory with three repetitions (at least two). The analysis period for the laboratories until the analysis results are handed over to the organisers is about 4 months. The results and measured values are submitted in particular data sheets (MS Excel-based), if necessary with the corresponding curves of biogas and methane formation. Since the quality assurance of the biogas laboratories is the goal of the proficiency test, no plausibility check is carried out on the submitted laboratory data by the organisation (round robin test type Q).

The inter-laboratory test is carried out and evaluated anonymously, for which each participating laboratory receives an individual identification number. At the end of the proficiency test, the laboratories receive a comprehensive written report including the laboratory assessments, all relevant comments, method descriptions and individual results of the complete test.

At the end of the evaluation process, the organisers of the proficiency test usually arrange a meeting where the laboratory representatives can discuss the results and possible sources of errors or problems that have risen together with the KTBL working group. This results in some interesting indications for the improvement of the laboratory work.

Evaluation of the Proficiency Test Biogas

The evaluation report of the proficiency test biogas of KTBL and VDLUFA includes all analysis areas and the corresponding parameters as well as all relevant notes, method descriptions and individual results for the respective year. The results of the laboratory evaluation are mainly presented by the systematic deviations/comparability of the laboratory results (z-value according to method description). The evaluation is carried out according to DIN

standard No. 5725 "Accuracy (correctness and precision) of measuring methods and results" (DIN 1997 and DIN 2002), in order to describe the performance of the analysis method, and DIN standard No. 38402-45 "Standard methods for water, wastewater and sludge analysis - Part 45: inter-laboratory tests for suitability testing of laboratories" (DIN 2014).

The evaluation of the proficiency test by means of DIN standard No. 5725 serves to describe the possibilities of the method and in particular the comparability of the results across the laboratories. The scatter of the results is calculated, among other things, as comparability (s_R) and repeatability standard deviation (s_r). According to DIN standard 5725-2 (2002), individual values are determined as outliers, if they do not match the other values of this laboratory. Furthermore, all values of a laboratory are marked, if the laboratory mean value of this laboratory deviates statistically significantly from the mean value of all laboratories or if the laboratory internal dispersion is increased. For all three types of outliers, a distinction is made as to whether these outliers are significantly at the 1% level (then these measurement results are removed from the evaluation) or whether the significance is only given at the 5% level (then these values are marked and taken into account in further calculations). Outliers are also removed from the evaluation by hand, without statistical calculations, if there are justified doubts about the data. The proficiency test organisers document these decisions.

Because of the evaluation according to DIN standard 5725, the following characteristic data of the method are obtained:

- variation coefficient of repeatability (CVr) - relative accuracy of values within a single laboratory
- repeatability standard deviation (s_r) - scattering of individual values within a single laboratory
- coefficient of variation of comparability (CVR) - relative precision between laboratories
- comparability standard deviation (s_R) - scattering of the mean values between the laboratories involved.

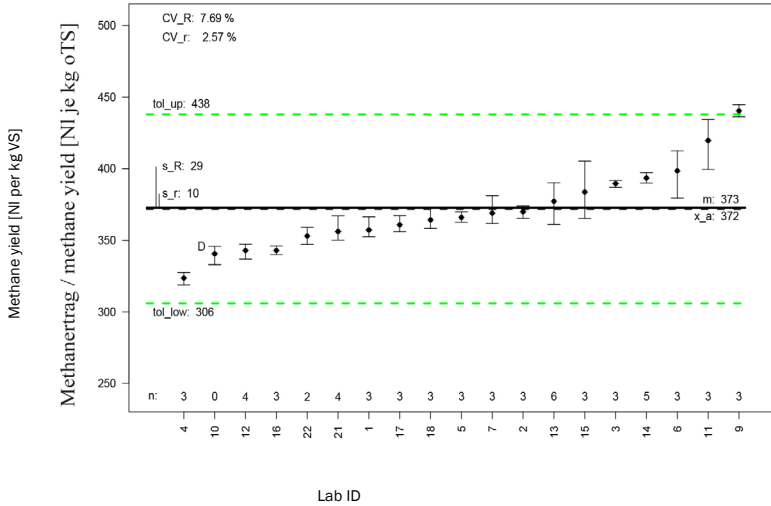

Figure 8.1-1: Scattering of the submitted analysis values for comparative laboratory assessment of the methane yield for the sample microcrystalline cellulose as example (VDLUFÄ and KTBL 2017)

The Fig. 8.1-1 from the evaluation report of 2016 (VDLUFÄ and KTBL 2017) shows the resulting scattering of the submitted analysis values for comparative laboratory evaluation, exemplified by the parameter methane yield for the sample microcrystalline cellulose.

The solid horizontal line (m) indicates the mean value of the analyses from this round robin test. The dashed lines (x_a) - if any - mark the "true value". The green dashed lines mark the upper and lower tolerance limits (tol_{up} and tol_{low}) calculated with the standard deviation of the method according to the standard.

In addition, DIN standard 38402-45 (2014) is used in the evaluation to enable the laboratory assessment. For this purpose, an existing method description – see paragraph on DIN 5725 – is presupposed. The z-values (standardised normal distribution) are calculated and displayed. The tolerance limits are determined with $m \pm 2 \cdot$ comparative standard deviation (s_R) or $x_a \pm 2 \cdot s_R$ if a "true value" has been assigned to the samples, where m is the mean value of the analyses from the proficiency test and x_a is the target value of the samples. As a result of the laboratory evaluation, a z-value is obtained for each laboratory and each sample. The z-values, which are in the range of ± 2 , are defined as values "without significant deviations". In this way, systematic deviations in the laboratories can easily be detected (see Fig. 8.1-2).

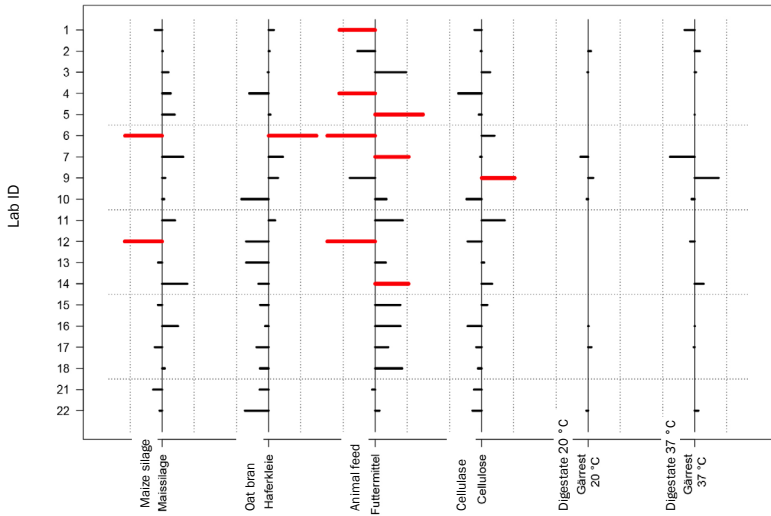

Figure 8.1-2: Overview of z-values (standardised normal distribution) for the proficiency test samples in the analysis scope 'fermentation test' and residual methane potential, using the example of methane yield (VDLUFA and KTBL 2017). The vertical dashed lines mark a z-value of 2.0 or -2.0. The horizontal dashed lines are auxiliary lines for horizontal orientation. The laboratories are vertical, the samples horizontal. Red bars mark laboratories whose laboratory mean value for this sample is less than -2 or greater than 2 (outlier)

Some results of the proficiency test biogas evaluation over the years

The first findings from the study of the inter-laboratory test data show that the results of the analysis have improved significantly despite the increasing demands on the measurements, changing laboratories among the participants and varying numbers of participants over the past years (WEINRICH AND PATERSON 2017). Since the composition of the laboratories participating in the proficiency test changes annually, a comparison of the evaluation over the duration of the test is only possible to a limited extent.

The scattering is represented by the variation coefficient of repeatability (CV_r) and coefficient of variation of comparability (CV_R) for microcrystalline cellulose (reference standard) and maize silage samples (see Fig. 8.1-3 and Fig. 8.1-4).

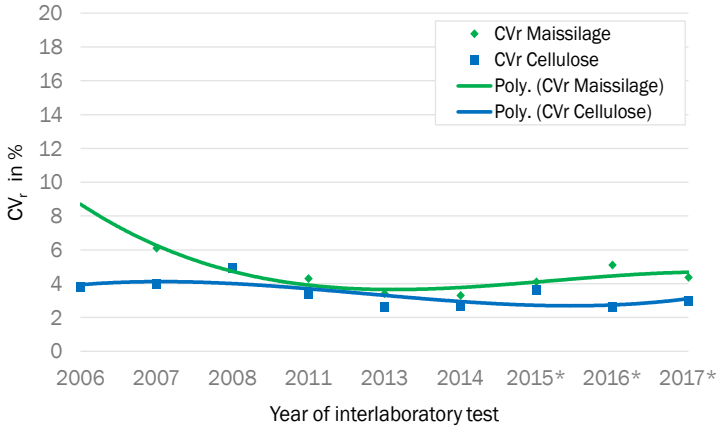

Figure 8.1-3: Development of the repeatability coefficient (CV_r) in the KTBL/VDLUFA proficiency test biogas (years 2006 to 2017) for the determination of the methane yield of microcrystalline cellulose (reference standard) and maize silage.

*The change in the objective of the inter-laboratory test from testing the implementation of the VDLUFA method (with plausibility control of incoming laboratory data) to quality assessment of laboratories (without plausibility control of incoming laboratory data) explains the changes in the repeatability coefficients

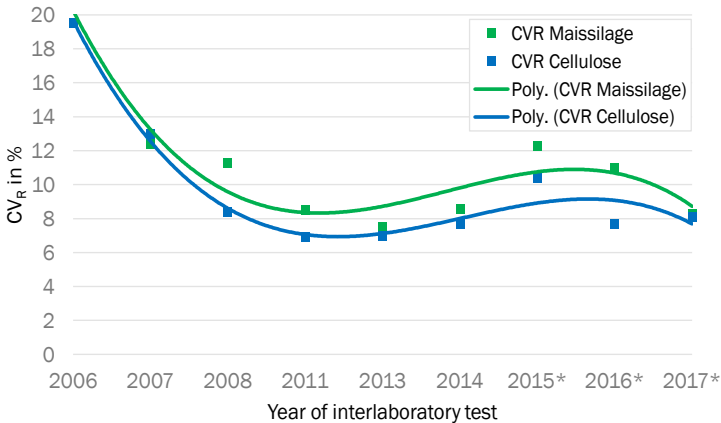

Figure 8.1-4: Development of the comparability variation coefficient (CV_r) in the KTBL/VDLUFA proficiency test biogas (years 2006 to 2017) for the determination of biogas and methane yield of microcrystalline cellulose (reference standard) and maize silage.

*The change in the objective of the inter-laboratory test from testing the implementation of the VDLUFA method (with plausibility control of incoming laboratory data) to quality assessment of laboratories (without plausibility control of incoming laboratory data) explains the changes in the comparative variation coefficients

It is striking, that at the first run in 2006 the results for cellulose showed a relatively wide spread, although a standardised and very homogeneous test substrate was used. The comparability coefficient of variation of methane yield between laboratories was 19.5%.

When comparing the test setups and the results, it became clear that the deviations were not related to the type and size of the respective test facilities. Rather, the procedure of data collection, the accuracy of methane measuring instruments, their regular calibration, the mathematical evaluation taking into account the reference values for standard conditions and the consideration of water vapour correction in the event of deviations played a clearly more recognisable role (OECHSNER AND PATERSON 2013). In the meantime, the CV_R values for the methane yield for cellulose are around 8%. The repeatability coefficient (CV_p), which describes the accuracy of the values within the laboratory, was reduced to less than 3% for the methane yield in the years of the test runs.

A slightly different picture emerges by looking at the results of determining the methane yield of maize silage. The coefficient of variation (CV_p) of the laboratories could be improved from initially more than 6% to now about 4%. Here, the inter-laboratory tests began with high CV_R values (of over 12% and over the years of the inter-laboratory test the scattering for this sample material could be reduced to around 8%. In the meantime, however, they rose again slightly in some cases. For such a substrate, possible natural quality differences between the cultivation years, the influence of comminution technology and the influence of silage play a role in the development of the results. It has to be mentioned, that no correction for volatile fatty acids was included in the test. This can also lead to certain distortions of the results. Furthermore, in 2015, the objective of the inter-laboratory test was changed towards the quality assessment of the laboratories. Thus, the plausibility check of the incoming laboratory data applied up to then was omitted, which partly explains the deterioration in the evaluation in the final years of the comparison.

Also the homogeneity of the sample has had an influence on the comparison of the test evaluations over the years; the maize silage is sent to the laboratories without pre-comminution and the sample gets prepared as is customary in the respective laboratory. For this reason, higher and more fluctuating CV_R values are generally plausible for maize silage compared to cellulose. Due to the increasing relevance of the determination of the residual methane potential for the efficiency assessment of existing biogas plants, the KTBL working group decided to include the residual methane determination of digestate in the analysis spectrum of the proficiency test biogas. As it turned out during the first evaluations of the proficiency test, with regard to the determination of residual methane, numerous biogas laboratories had considerable potential for optimisation when determining this parameter. This is similar to the results at the beginning of the inter-laboratory test for biogas yield measurements. This knowledge and the fact that special requirements must also be observed for practical test results, the VDLUFA method "Determination of the residual gas potential from digestate in the laboratory test" was written especially for this experimental approach (VDLUFA 2019).

CERTIFICATE

Laboratory X

attended successfully the
Proficiency Test Biogas 2016
under the identification no.

No. Y

The methane content of maize silage, oats bran and
microcrystalline cellulose as standard has been analysed.

Darmstadt, 3rd Juli 2017

KTBL



Dr. Martin Kuntich
Managing Director of Association for
Technology and Structures in Agriculture
Kontinuum für Technik und Prozesse in der Landwirtschaft e.V. (KTBL)
Bismarckstr. 40 | 64289 Darmstadt | www.ktbl.de

VDLUFA



Dr. Peter Tillmann
Managing Director of VDLUFA
Association NRE GmbH
VDLUFA Qualitätsforschung NRE GmbH
Tischbein 28 | 34109 Kassel | www.vdlufa.de

Figure 8.1-5: Example of the quality seal (certificate) of the KTBL/VDLUFA Proficiency Test Biogas Yields for the successful participation in the analysis scope 'fermentation test'

Quality feature of the proficiency test biogas

Since 2015, the proficiency test biogas has been based exclusively on the quality improvement approach of the laboratories (round robin test type Q), for which the quality seal issued by the test organisers (certificate) on successful participation is suitable. Due to the quality improvement, the proficiency test organisers do not check the plausibility of the received data of the participating laboratories.

After completion of the test, the participating laboratories receive a seal of quality for their "successful" participation. This certificate currently only refers to the correct determination of gas yields (analysis scope fermentation test) and does not affect the parameters residual methane potential and raw nutrients. The quality seal is issued individually to a laboratory, if

- all major samples have been analysed,
- the standardised normal distribution (z-value) from 2 of 3 samples is at maximum of ± 2 and
- the target biogas or methane yield of the cellulose has been determined according to the VDLUFA method.

Project-accompanying working group

From the very beginning, the KTBL working group "Proficiency Test Biogas Yields" is supporting the inter-laboratory test during implementation, the technical discussion as well as the practical research into the causes.

Table 8.1-1: Members of the KTBL working group "Proficiency Test Biogas Yields"

Member	Institution
Dr. Manfred Bischoff	LUFA North-West
Florian Ebertseder	Bavarian State Research Center for Agriculture
Dr. Christiane Herrmann	Leibniz Institute of Agricultural Engineering and Bioeconomics
Gabriele Meißbauer	Schmack Biogas Service
Dr. Hans Oechsner (Chairman)	University of Hohenheim
Dr. Susanne Ohl	Chamber of Agriculture Schleswig-Holstein
Dr.-Ing. Jürgen Pröter	DBFZ Deutsches Biomasseforschungszentrum gemeinnützige GmbH
Dr. Peter Tillmann	VDLUFA Quality Assurance NIRS

Summary

Over the past 13 years, extensive experiences in determining the methane yield from various organic substrates have been gained and there are numerous of publications on this matter. In Germany, the VDI GUIDELINE 4630 and the VDLUFA Method description have been established in order to harmonise the execution of experiments in the laboratories and to achieve reliable results in the performance of fermentation tests.

Despite the established methodological regulations, it is indispensable for the laboratories to participate at laboratory-wide quality improvement measures in order to test and objectively present their performance. The analytical performance of a laboratory can best be tested in an inter-laboratory test in comparison with other laboratories.

Since 2006, the German Association for Technology and Structures in Agriculture (KTBL) together with VDLUFA Quality Assurance NIRS GmbH (VDLUFA) carries out the Proficiency Test Biogas for biogas laboratories, which now involve between 20 and 30 laboratories from Germany and abroad every year. These laboratories observe the given guidelines as far as possible, but they often work with different equipment and experimental setups, which is also permissible. The quality of the results of the KTBL/VDLUFA inter-laboratory tests has been continuously improving over the years of the inter-laboratory tests. However, it also

emerged that it is essential for the basic conditions of the directives to be compiled in order to obtain comparable results. These are e.g. the selection and quality of the inoculum, the appropriate mixing ratios of the test substrate and the inoculum, gas-tight test equipment, regularly calibrated measuring instruments and an optimised evaluation of the gas yields taking into account the temperature and pressure conditions to normalise the values.

Efforts to identify and eliminate sources of error in the participating laboratories are currently underway in order to achieve further improvement of the internal and cross-laboratory standard deviations. Further information on the Proficiency Test Biogas of KTBL and VDLUFA can be found at www.ringversuch-biogas.de.

8.2 Biogas Interlaboratory Tests at the Bavarian State Research Center for Agriculture (LfL)

Günter Henkelmann, Christian Vogt, Bavarian State Research Center for Agriculture, LfL

Test requirements/ Test procedure	Interlaboratory tests. The samples are taken directly from a biogas plant and are prepared according to the subsequent use (grinding, drying, etc.). This is followed by in-house homogeneity and stability testing to ensure a perfect sample material. Afterwards, the samples are sent to the participating laboratories. After the samples have been measured by the laboratories with their own methods, the results obtained are statistically evaluated, and the laboratories are rated according to their analytical performance. This is followed by the preparation and dispatch of the reports and certificates to the laboratories.
Substrate used	Maize silage (dried), fermenter contents (liquid and dried), digestate with added carboxylic acids, digestate (liquid)
Result interpretation	The laboratory results of the LfL biogas interlaboratory tests were evaluated by using the software PROLab plus of the company QuoData, "Society for quality management and statistics mbH" according to DIN 38402 A-45. The evaluation module Q-method with Hampel-estimation was used.
Key statements from the tests	Bavarian State Research Center for Agriculture (LfL) offers the opportunity for laboratories to verify their analytics. They can compare them with other biogas analysis laboratories. Furthermore, the regular participation in the interlaboratory tests provides the laboratories the opportunity to verify their analytical results and to have their methodology accredited. This will improve the quality of the processes in the agricultural fermentation technology used by the farmers and producers of methane and energy.

There is currently a strong expansion of alternative energy supply worldwide. The generation of energy by means of renewable raw materials and their fermentation to biogas nowadays play an increasingly role. In the field of bioenergy, the market and rising raw material prices are forcing farmers and operators of biogas plants to aim for higher efficiency, a better utilization of the capacity, higher yields and comprehensive economic considerations. Accurate and correct chemical analysis is, therefore, essential for the fermentation process and for calculating the yield of methane. Problems in the fermenter from nominal or empirical values may inhibit biogas production or, in the worst case, lead to a "tipping over" of the fermenter. However, the farmer can only control his plant effectively if he can rely on the results obtained from the laboratories. In this context, the LfL offers the opportunity for laboratories to verify their analytics and to compare them with other biogas analysis laboratories.

Furthermore, the regular participation in the interlaboratory tests provides the laboratories the opportunity to verify their analytical results and to have their methodology accredited.

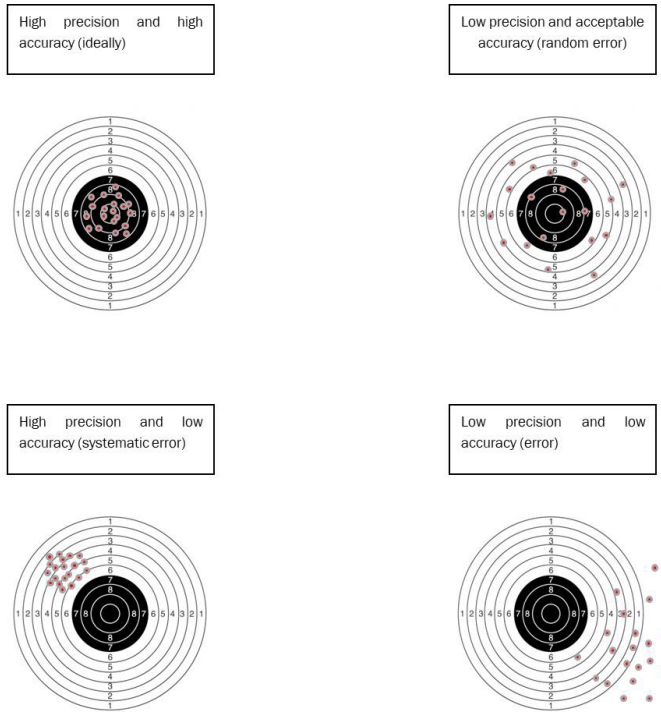

Figure 8.2-1: Representation of various possible analytical error types

The biogas process can be seen as a biological process in which organic substance (input material) is degraded in the absence of oxygen (anaerobically). The process generates biomethane as a desired energy source, carbon dioxide and the so-called digestate, which is used as an organic fertilizer. This complex process of biogas production is significantly influenced by various factors. These include for example the dosage and the quality of the input materials (substrates), the amount of available trace elements in the fermenter but also inhibitors that can limit gas production, and in the worst case, can lead to a complete breakdown of the entire microbiology in the fermenter. Profound knowledge of the exact chemical, biological and physical process parameters in the fermenter is, thus, of great importance for the trouble-free operation of a biogas plant. By accompanying laboratory analysis, the operator of a biogas plant can access a variety of chemical process parameters and intervene correctively in the process, in case of identified deviations from experience or set points. However, this requires reliable analytical laboratory results.

Fig. 8.2-1 shows various errors that may play a role in the analysis of samples in biogas production. Precision is a criterion for assessing the quality of a measurement or measurement method. The correctness is a term for the degree of approximation of an expectation value to a "true value". In addition to high precision of the results, the ideal case presupposes also a high result accuracy. The laboratory then returns values that are close to the "true value" of the analysis. If there is a systematic error in the analysis, still a high precision of the results can be guaranteed, but the average overall result is far from the "true value". Here, for example, errors in the performance of the method (weighing, pipetting, etc.) could be responsible for a deviation. Laboratory operators without any participation in an interlaboratory test have no possibility to check the correctness and precision of their analyses. Only by multiple participation in interlaboratory tests can laboratories detect errors in their analytics, compare their analytical results with other laboratories, and ultimately, optimise the methods by interpreting the errors. In order to give the laboratories these possibilities and to ensure a consistently high quality of analysis by the laboratories, the LfL, therefore, offers regular interlaboratory tests.

Problem Statement

Accurate and correct analysis is essential in the field of biogas analysis. Controlling and regulating the biological process in a biogas plant, therefore, plays an increasingly important role in times of rising raw material prices. However, the farmer can only control his plant effectively if he can rely on the results obtained from the laboratory. In this context, the LfL offers an opportunity for laboratories to verify their analytics and to compare them with other biogas analysis laboratories.

Furthermore, regular participation in the interlaboratory tests gives the laboratories the opportunity to verify their analytical results and to have their methodology accredited.



Figure 8.2-2: Development of participants, parameters and samples in comparison. Displayed are the interlaboratory tests 1-10

Goals

The goal of the independent interlaboratory tests at the LfL is for the laboratory service providers to become involved in a regular review and control of the applied analytics. Due to the lack of generally accepted methods or special DIN standards for the analysis of biogas samples as well as the various matrices to be investigated (for example, silage, fermenter residue, digestate), laboratories can hardly estimate their analytically determined results. Therefore, interlaboratory tests represent a practicable solution for method verification.

Internal laboratory methods and other analytical methods can be directly compared between different laboratories. This leads to a continuous increase in the quality of the analysis within the laboratory. The operators of biogas plants ultimately benefit from these precise analytical results. Only an error free and consistently good laboratory analysis offers the operator of a biogas plant the opportunity to monitor and assess the biogas production. This requires training, the provision of knowledge and the preparation of complex data-relationships in a comprehensible form. Operators of biogas plants and farmers also currently have a great need for information regarding the use of on-site analysis and laboratory analysis for process monitoring.

LfL Biogas Interlaboratory Tests

A total of 488 laboratories participated in the last 12 LfL biogas interlaboratory tests conducted in 2008–2018. Many laboratories have taken part repeatedly and have become "regular customers" from interlaboratory test 1 to interlaboratory test 12.

As shown in Fig. 8.2-2, the average number of participants is around 40 laboratories per interlaboratory test. This number of participants is well suited for a reliable statistical evaluation as well as for a meaningful sample preparation. If there were significantly fewer participants, the statistical results would be disproportionately influenced by individual outlier labs. If, on the other hand, there were significantly more participants, we would have problems with sample preparation, especially with the homogenisation and provision of sufficient sample material.

Interlaboratory test number 5 was the first paid test offered by the LfL. This explains the decrease in the number of participants by 8 laboratories from interlaboratory test 4 to interlaboratory test 5.

The number of sample matrices has risen steadily, from 3 different matrices in 2008 in the 1st ring trial (see Tab. 8.2-1) to 6 different matrices in 2016 in the 10th ring trial (see Tab. 8.2-3). The number of possible survey parameters has also risen from 34 in 2008 to 53 in 2020.

Tab. 8.2-1 and Tab. 8.2-2 comparatively show the possible interlaboratory test groups and parameters for the participating laboratories of the 1st interlaboratory test in 2008 and the most recent 14th interlaboratory test in 2020. The number of interlaboratory test groups has increased by three. The interlaboratory research group 3: Minerals was newly established

as an independent group. Like-wise, the groups 4: carboxylic acids, and 5: nutrients in the digestate (new since 2015) have been recently created in the course of the collaborative trials. Furthermore, the possibility of investigating the digestate for residual gas potential and methane content in interlaboratory group 6: digestate was made possible. The newly added proficiency testing groups/parameters give the labs the opportunity to react to changed market situations, and were very well received by the participants.

Table 8.2-1: Distribution of the feeding amounts of continuous fermentation tests

Interlaboratory test group	Matrix	Parameter
Sample 1	Maize silage, dried	C_{total} , S_{total} , N_{total} , ADF, ADL, NDF, crude fiber, crude fat, crude protein, sugar, starch
Sample 2	Fermenter contents, liquid	pH, volatile organic acid, total alkaline carbonate, carboxylic acids (Acetic acid, propionic acid, butyric acid, iso-butyric acid, valeric acid, iso-valeric acid, hexanoic acid), NH_4 -N
Sample 3	Fermenter contents, dried	C_{total} , S_{total} , N_{total} , Na, K, Ca, Mg, P, Co, Ni, Cu, Cd, Zn

Table 8.2-2: Overview of the interlaboratory test groups and parameters in the last 14 interlaboratory tests

Interlaboratory test group	Matrix	Parameter
1 Raw Material	Maize silage, dried	C_{total} , S_{total} , N_{total} , ADF, ADL, NDF, crude ash, crude fiber, crude fat, crude protein, sugar, starch
2 Fermenter contents	Fermenter contents, liquid	Volatile organic acid, total alkaline carbonate, NH_4 -N, total solids (TS), volatile solids (VS), pH, acetic acid, propionic acid, acetic acid equivalent
3 Minerals	Fermenter contents, liquid	B, Cd, Co, Cr, Cu, Mo, Na, Ni, Se, Zn
4 Carboxylic acids	Digestate with added carboxylic acids	Acetic acid, propionic acid, butyric acid, iso-butyric acid, valeric acid, iso-valeric acid, caproic acid
5 Nutrients in the digestate	Digestate, liquid	N_{total} , P, K, S_{total} , Ca, Mg, NH_4 -N, total solids, pH
6 Digestate	Digestate, liquid	Residual gas quantity after 10 test days Residual gas quantity after 20 test days Residual gas quantity at discontinuation of the measurement series Methane content after 10 test days Methane content after 20 test days Methane content at discontinuation of the measurement series

Fig. 8.2-3 shows a flowsheet of an interlaboratory test, beginning with the planning of the test and information to the laboratories. The samples are taken in the first step (preparation) directly from a biogas plant and are prepared according to the subsequent use (grinding, drying, etc.). This is followed by in-house homogeneity and stability testing to ensure a perfect sample material. Afterwards, the samples are safely packed and sent to the participating laboratories. After the samples have been measured by the laboratories, the results obtained are statistically evaluated, and the laboratories are rated according to their analytical performance. This is followed by the preparation and dispatch of the reports and certificates to the laboratories.

At all participating laboratories, an annual interlaboratory test has been established.

The sample material was provided with the kind support of the Institute for Animal Nutrition and Feed Management of the Bavarian State Research Center for Agriculture (LfL) in Grub (maize silage) as well as by the biogas plant Pellmeyer in Eggertshofen near Freising (digester content/digestate). The samples were sent to the participating laboratories by DPD (Dynamic Parcel Distribution GmbH & Co. KG).

The laboratory results of the LfL biogas interlaboratory tests were evaluated by using the software PROLab plus of the company QuoData, "Society for quality management and statistics mbH" according to DIN 38402 A-45, as authorized by the "Association of Agricultural Research and Research Institutes" (VDLUFA). The evaluation module Q-method with Hampel-estimation was used. Participation in a group was successful when at least two-thirds (66.6%) of the parameters included in this group were successfully analyzed.

The prerequisite for a positive result in the interlaboratory test was satisfactory information in the form such as information on the performance of the measurements, as a used method, and the limit of detection and the limit of quantification for the analyte. A feature was considered "successfully analyzed" if the Z_u -score did not exceed ± 2.00 .

The calculation of the Z_u -scores was done by using the following formula:

$$Z_u = \frac{\text{result of the laboratory} - \text{target value} * 1.96}{\text{standard deviation} \quad k1 \text{ or } k2}$$

89

The "result of the laboratory" corresponds to the measured value of the laboratory. "Target value" is the average measured value of all laboratories (the set point, determined by Hampel-estimation). The comparison standard deviation corresponds to the difference between the laboratories (determined by the Q-method). Furthermore, factors k_1 and k_2 (negative (k_1) and positive (k_2) asymmetric tolerance coefficients) were introduced to avoid favoring low recoveries (as in Z-scores) (for small comparison standard deviations, k_1 and k_2 converge to the value 1.96, followed by the Z_u -score = Z-score).

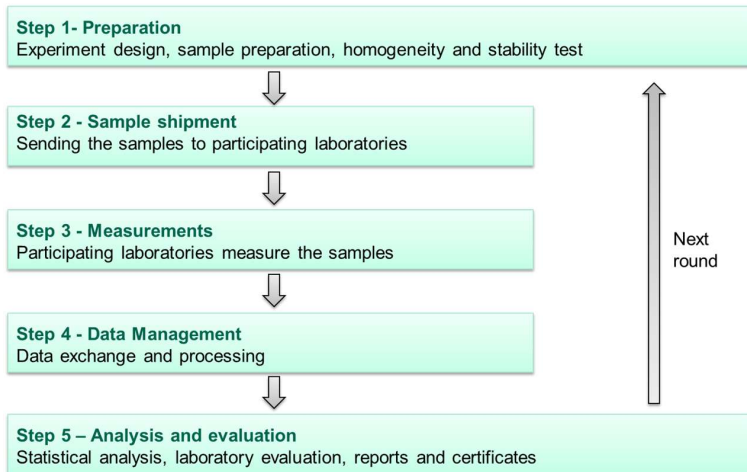

Figure 8.2-3: Schematic sequence of the LfL biogas interlaboratory test (related to the current 12th interlaboratory test)

The participating laboratories receive the evaluation in the form of a detailed report. If the publication of the results is approved by the laboratories for publication it is published on the website of the Biogas Forum Bavaria (www.biogas-forum-bayern.de).

Results of the interlaboratory tests 2008-2018

Quality

The interlaboratory tests already carried out received a positive response from the participating laboratories. A consistently high number of participants of up to 50 participants per interlaboratory test shows a great interest in general. Likewise, in a recent survey, the laboratories all voted for a continuation of the interlaboratory tests. Above all, the laboratories praised the regular conduct of the interlaboratory tests, the detailed and comprehensive statistical evaluation as well as the possibility to control and compare the determined analytical results.

Evaluation according to the interlaboratory test groups

Over the years, the interlaboratory testing schemes have been able to continuously increase the analytical quality of the laboratories. Fig. 8.2-4 shows the success of the interlaboratory tests 4 to 10. The proportion of laboratories able to meet the requirements of the respective interlaboratory testing group is given as a percentage. A continuous increase in the analytical quality of the laboratories is visible for all participating interlaboratory test groups. In the ring trial group 1: maize silage/raw material, an increase of correct analysis

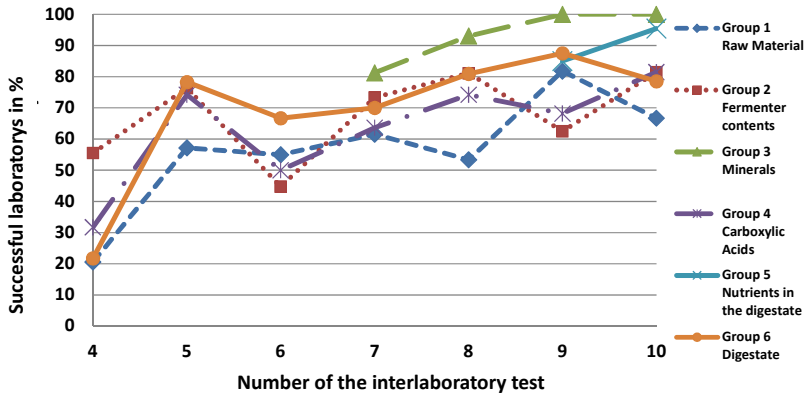

Figure 8.2-4: Percentage of laboratories that have positively passed the relevant interlaboratory test group according to the evaluation criteria of the individual tests

from 21% in the 4th interlaboratory test to 67% in the 10th interlaboratory test was achieved. In the interlaboratory test group 6, an increase in the analytical accuracy of the digestate from 22% in the ring trial number 4 up to 79% in the ring trial number 10 could be found. Furthermore, the ring trial group 3 minerals in the 9th and 10th interlaboratory tests already showed a 100% accurate analytical result of the participating laboratories.

Evaluation based on the Z_u -scores for individual Interlaboratory Test Groups and Parameters

The evaluation of the elements in the ring trial group 1, maize silage: carbon (C), nitrogen (N) and sulfur (S) is presented in the diagram shown in Fig. 8.2-5. In the earlier interlaboratory comparisons, especially in interlaboratory tests 4–8, the criteria for successfully passing the individual parameters could not be met by a larger percentage of the laboratories. For example, in the 4th interlaboratory test, about 40% of the participating laboratories reported an analysis value outside the tolerance limits for the analysis of sulfur. For nitrogen, the value was 26% and for carbon, 21%. In comparison to this, in the ring trials 9th and 10th, all the participating laboratories have achieved an analysis result within the tolerance limits for the elements.

The aim of the interlaboratory tests is to improve the analytics of the input material, fermenter and fermentation analyses. This will create more transparency in the process of the methane production and can be used in the laboratories to select new suitable analytical methods. In addition, the operator of a biogas plant is offered intensive knowledge transfer via the online portal. Furthermore he is provided with a list of successful participants in the interlaboratory tests and can select a suitable laboratory for his analysis purposes. The LfL interlaboratory comparisons are well recognized, have established on the European market and have contributed to significant increase in the quality of interlaboratory service providers in the field of biogas plants.

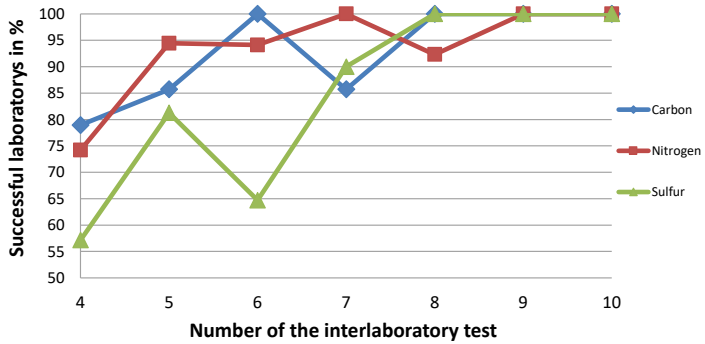

Figure 8.2-5: Interlaboratory tests 4–10: Ring trial group 1: Elements: carbon (C), nitrogen (N) and sulfur (S); Percentage of laboratories whose analytics were rated a Zu-score of $> |2|$

The methods used in these interlaboratory comparisons are not prescribed. Therefore, the results may differ significantly according to the method of the measurement. Therefore, at a later stage of the evaluation it is planned to examine the influence of the methods on the analytical results. The aim is to give recommendations for the best methods to be used.

8.3 LfL - Batch test

Vasilis Dandikas, Fabian Lichti, Bavarian State Research Center for Agriculture, LfL

Status	Development completed
Standard	VDI 4630 2016; VDLUFA 2011
Area of application of the method	Organic solid or liquid material
Disadvantage	Complex, costly, time-consuming process
Advantage	Precise measurement with high sensitivity and temporal resolution
Need for research	<ul style="list-style-type: none"> ● Inter-laboratory repeatability and reproducibility ● Evaluation of degradation kinetics
Necessary sample preparation	The particle size of the sample should be less than 10 mm
Sample quantities	The needed quantity of the sample depends on the ratio of volatile solids of the test sample to volatile solids of the inoculum. The kinetics of the biogas production (degradation rate) should also be considered.
Special characteristics	<p>The volume of the produced biogas is continuously measured (i.e. every ca. 1 mL biogas produced)</p> <p>Gas analysis is performed for every 1.5 L biogas produced (measurement of CH₄, CO₂ and O₂ content)</p> <p>The incubation temperature is 38 °C</p>
Quality criteria applied	<p>The biogas yield of the positive control should be between 80 and 100% of the theoretical value.</p> <p>The coefficient of variation of the replicates should be less than 10%.</p> <p>No negative values should be obtained for the calculated biogas yield.</p>

Batch test

Biogas and methane yields are important parameters to assess any biodegradable material and define its suitability as feedstock in a biogas plant. Moreover, the kinetics of the biogas production (degradation rate) in a batch test reveals differences among feedstocks, while useful information for substrate characterisation can be exposed.

The biogas yield and the degradation rate of feedstocks can be determined by anaerobic digestion batch tests. The biogas yield describes the maximum biogas production per amount of substrate added under optimal and well-defined laboratory conditions. The methane content in biogas will be analysed to define the methane yield. Although, for energy production only the methane amount can be utilised, the biogas amount is impor-

tant in order to undertake biogas plant design and operation. To achieve a more efficient operation of biogas plants, it is important to determine the biogas yield in advance. Batch tests make this possible but a strict standardisation is needed to secure inter- and intra-laboratory reproducibility.

The Association of German Engineers (VDI) has developed a guideline for the determination of biogas and methane yields of organic substances (VDI 4630 2006). The guideline describes the process conditions for a standardised batch test. In 2011, the Association of German Agricultural Analytic and Research Institutes (VDLUFA) published a method for the determination of biogas and methane yields of agricultural biomass (VDLUFA 2011). In the VDLUFA method, some process conditions were specifically defined with respect to the batch test of agricultural substrates. In 2016 an updated version of the VDI guideline has been published (VDI 4630 2016).

The batch test procedure at LfL is presented in the following section. The batch tests are performed according to the VDI 4630 (2016) guideline and the VDLUFA method book (2011).

Experimental set-up at LfL

Fig. 8.3-1 shows the batch system of LfL. Each incubator contains 12 digesters; each digester is connected by tubes with a MilliGascounter (Dr.-Ing. Ritter Apparatebau GmbH & Co. KG) for volume recording. A gas bag is attached to three digesters and gas analysis is performed for every 1.5 L biogas produced. The batch digesters have a total volume of 2 L and a working volume of approximately 1.5 L. The experiments are performed at mesophilic conditions, i.e. the temperature is set to $38 \pm 0.5^\circ\text{C}$.

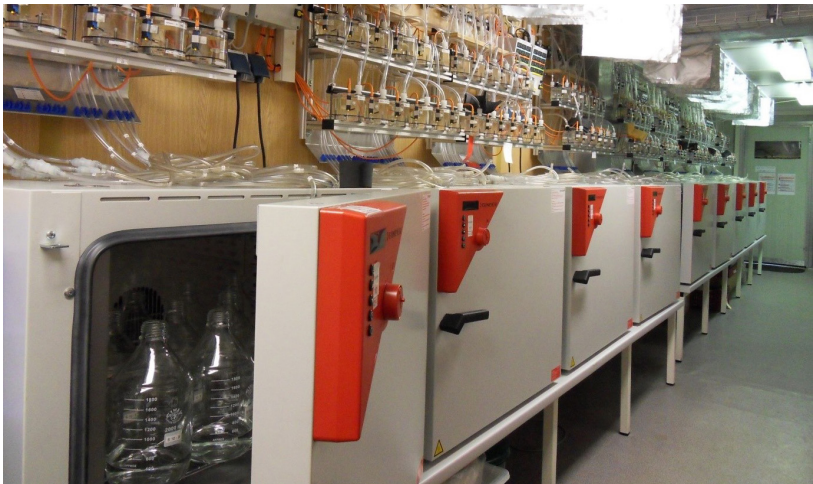

Figure 8.3-1: Batch test system of LfL

To determine the endogenous biogas production of the inoculum, three digesters are filled with inoculum material only. Microcrystalline cellulose and a defined sample of dried whole plant maize serve as positive controls, in order to verify the biological activity of the inoculum. Each sample must be tested at least in triplicate (technical replicate). However, in order to ensure statistical accuracy, six replicates (analytical replicate) are used for microcrystalline cellulose.

Sample preparation and storage

The quality of the results is affected by sampling and sample preparation. The sampling should be performed according to VDI 4630, 2016. The feedstocks are ground to 10 mm with a cutting mill in order to achieve a homogeneous sample and the degradation rate (kinetics) to be comparable among the samples. A detailed description of sample preparation and storage can also be found in (HOLLIGER et al. 2016).

Inoculum

Inocula with similar chemical and physical properties are used for batch experiments at LfL, since the properties of the inoculum affect the biological degradability of the sample and the kinetics of the biogas production. To obtain a defined biocenosis, a pilot digester (continuously stirred-tank reactor) with a working volume of 2.5 m³ is operated under steady-state conditions. The digester is run at an organic loading rate of 2.5 kg_{VS} (m³*d)⁻¹ with an 80% cattle manure and 20% dairy cattle feed mixture (total mixed ration (TMR)). TMR is mostly composed of maize and grass silage. The digester is operated at 38 ± 1 °C and a hydraulic retention time (HRT) of 22 days.

One week prior to batch test, the effluent of the digester (defined biocenosis) is sieved through a 10 mm screen and stored at the test temperature of 38 ± 1 °C without feeding to reduce endogenous biogas production. The degassed material is used as an inoculum for batch tests. To ensure the quality of inoculum, chemical analysis is performed before the experiment and the following parameters are recorded: total solids (TS), volatile solids (VS), pH, volatile fatty acids (VFA), total ammonia nitrogen (NH₄-N), total inorganic carbon (alkalinity) and the ratio volatile organic acids to total inorganic carbon (VOA/TIC).

Analyses

Volume measurement

The produced biogas flows through the gas inlet nozzle into a capillary of the counter tank, which is filled with silicon oil. The gas then moves to the two-chamber measurement cell. The measuring of the gas volume occurs in discrete steps by counting the tilts of the measurement cell with a resolution of approximately 1 mL. Each MilliGascounter is regularly calibrated to define the exact volume for each tilt. The volume of the produced biogas is measured with an accuracy ± 3% of reading (Dr.-Ing. Ritter Apparatebau GmbH & Co. KG). The measurements are recorded online and stored on an hourly basis.

Biogas composition

As Fig. 8.3-2 shows, the biogas produced from the three replicates of one sample is stored in a gas bag. The gas analyser individually measures each gas bag, each time that the necessary biogas volume is collected. Automatically, a determination of gas composition is performed using infrared sensors for the content of methane and carbon dioxide at an accuracy $\pm 2\%$ of reading, and an electrochemical sensor for the content of oxygen at an accuracy of 1% of reading (AWITE Bioenergie GmbH). The gas analyser is regularly tested with a defined gas mixture and is calibrated if required. Moreover, air pressure and room temperature are recorded hourly.

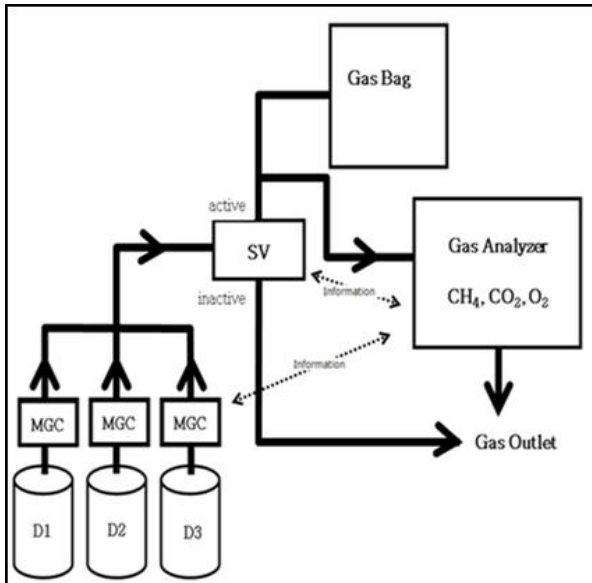

Figure 8.3-2: Schematic diagram of the batch test system of LfL. D: digester, MGC: Milligascounter, SV: solenoid valve (DANDIKAS et al. 2015)

Execution method

Each digester is filled with 500 mL of distilled water, 1,000 g of fresh matter (FM) inoculum and about 20 g of FM sample, if a dry sample has to be tested. Precision scale is used with two decimal digits, and among the replicates of the sample no more than the 1% difference is allowed. The needed quantity of the sample depends on the ratio of volatile solids of the test sample to volatile solids of the inoculum. To prevent any inhibition during the batch test, the kinetics of the biogas production (degradation rate) should also be considered.

With respect to sample characteristics, the following amounts are added:

- easily degradable feedstocks (e.g. sugar beets): 7–15 g of volatile solids
- moderately degradable feedstocks (e.g. maize silage): 15–17 g of volatile solids
- hardly degradable feedstocks (e.g. manure): 17–25 g of volatile solids

The ratio of volatile solids of the test substrate to volatile solids of the inoculum is usually 0.5 ± 0.1 . However, this ratio can vary from 0.2 to 0.8. The TS content in the digester varies between 4 and 5% of FM. About 2% of the overall working volume is volatile solids from the inoculum. A batch test can be terminated, when the daily biogas production is less than 0.5% of the total volume of biogas produced.

Data analysis

The biogas produced in each measuring period (each hour) is converted in litre of dry gas at standard temperature and pressure (STP) conditions. The hourly endogenous biogas production of inoculum (average value of the three replicates) is subtracted from the hourly biogas production of each digester with respect to the amount of inoculum added. Following, the net volume of biogas is divided by the amount of volatile solids added. The methane concentration has to be corrected for each measuring point (every 1.5 L biogas produced of each sample). The methane yield can be derived if the corrected methane content is multiplied by the net volume of each digester. A detailed description of the data analysis procedure is provided in the VDI GUIDELINE 2016 and in method book of VDLUFA 2011.

To assess the validity of the measurement, the biogas yield and the absolute difference on biogas yield among the replicates should be considered. Moreover, no negative values should be obtained for the calculated biogas yield. The experiment must be repeated, if the coefficient of variation of biogas yield of inoculum or of a single sample is too high ($> 10\%$), and if the biogas yield of the positive control is too low (less than 80% of the theoretical value). Elimination of a single outlier can be applied, if it can be statistically supported or technical issues were recorded during the experiment.

The final biogas and methane yields of a sample are the average values of at least two measured values and are reported as litre (STP) per kilogram volatile solids added ($\text{L kg}_{\text{VS}}^{-1}$).

8.4 Gas yield test (batch)

Marc Lincke, Björn Schwarz, Fraunhofer IKTS

Status	Development completed, applicable.
Associated standards	(VDI GUIDELINE 4630 2006); DIN 38414-8; VDLUFA Book of Methods VII, Environmental Analysis and Gas Yield Measurement 4.1.1
Type of substrate	Biogenous substrates of any composition
TS range	0%–100% (of the original sample, max. 10% of the substrate mixture in the fermenter)
Particle sizes	Maximum length: 5 cm (otherwise pre-shredding is required)
Limitations of the method	None, since any decomposition inhibition by the substrates to be tested is also subject of the analysis
Advantages	Simple and robust method
Need for research	Comparability to results of other methods and inoculum (inter-laboratory comparisons as they have already been carried out by KTBL)
Necessary sample preparation	No preparation necessary except homogenization and compatibility with reactor opening
Sample quantities	5 g–100 g (depending on the concentration of organic components)
Special characteristics (Mixing by daily shaking of the reactors, continuous gas production measurement is possible as well as daily recording
Quality criteria applied	Reference substrate microcrystalline cellulose.; triple determination with a maximum deviation of 5 %

With the help of gas yield tests, statements regarding the anaerobic decomposability, the quantity and quality of the gas yield achievable under optimal conditions and the qualitative assessment of the decomposition velocity can be made. Gas yield tests do not allow statements regarding the process stability of the continuous fermentation of the substrate, since inhibition or adaptation effects only occur after longer feeding cycles.

A VDI guideline (VDI GUIDELINE 4630 2006) for the execution of gas yield tests, discussing potential equipment, test set-ups, methods of characterisation and fundamental calculations very comprehensively, is existent. In the year 2012, the amended version of 2006 was revised. A VDLUFA prescribed method presents the most important steps of the analysis and validates the method through multiple inter-laboratory comparison runs. In the following section, as a practical example for a potential implementation of VDI GUIDELINE 4630, the batch fermentation plant of Fraunhofer IKTS Dresden as well as the concrete approach for the determination of the gas yield will be presented.

Sampling and sample preparation

Complementary to the rules and regulations of VDI GUIDELINE 4630, a sample preparation for solid substrates (in particular cutting or crushing) will only be applied if the untreated sample cannot be transferred into the fermentation apparatus or if the inhomogeneity of the initial sample does not allow a representative partial sample for the fermentation test. In this case, it has to be considered that the result of the biogas yield test does not necessarily correspond to the actual gas yield of the untreated sample as it could have been changed by the sample preparation.

Materials and devices

The test set-up (Fig. 8.4-1) was modelled after the guidelines of DIN 38414-8 and consists of the following components:

Water bath with thermostat unit:

- 1 litre glass reactor with a useable storage volume of 700 mL
- gas meter type Milligascounter® MGC-1 V3.0
- gas bag (diffusion-tight, PP connection)
- gas-tight hoses are located between the reactors and the Milligascounter® and the gas bags

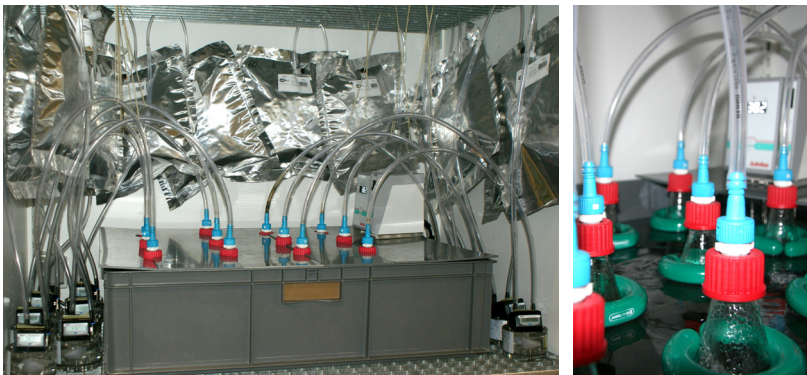

Figure 8.4-1: Batch reactors (1 litre scale), water bath, gas meter, gas bag (Source: IKTS)

With the exception of the thermostat unit, all components of the system are the result of comprehensive suitability tests with respect to tightness and measuring accuracy. For newly designed test facilities, such a verification is recommended since experience has shown that even commercially available components may have significant deficits with respect to tightness and measuring accuracy.

Execution method

As inoculum, active digested sludge (from the turnover) of a communal sewage treatment plant is utilised, which is – within a period of time of no more than 4 hours after sampling – filled into the glass reactors (600 g each). At an average TS content of 3.7% and a VS content of 50%, the criteria of the VDI guideline (organic share from the inoculum of 1.5% to 2.0% in the preparation) are safely adhered to. The inoculum is subjected to a starvation and recovery phase at a temperature of 38 °C for a period of time of approx. seven days. During this phase, a synchronism of the gas production in the individual reactors is ensured. Subsequent to the successful starting-up phase, the reactors are fed with the substrate to be analysed. The calculation of the sample quantities to be used is carried out in accordance with the provisions of VDI GUIDELINE 4630 based on the following equation.

$$\frac{VS_s}{VS_{\text{inoc}}} = 0.4$$

90

VS_s	Amount of volatile solids in the substrate	g
VS_{inoc}	Amount of volatile solids in the inoculum	g

The feeding is carried out by hand with the help of funnels directly into the reactor opening. For the verification of the biological activity of the inoculum, a micro-crystalline cellulose is carried along as a reference substrate with each preparation. For the determination of the own gas potential of the inoculum, at least three reactors are operated as reference without any addition of substrate. A purging of the headspace of the reactor (1 L) with nitrogen is not mandatory, since no differences in gas production were observed so far when the reactor was purged with nitrogen. Once the reactors have been fed, the gas meters are zeroed and empty gas bags are installed. An inspection of the test benches is conducted once a day, in which the following works steps are carried out:

- measurement of the current air pressure with the help of a digital barometer,
- measurement of the current room temperature with the help of a digital thermometer,
- reading out and logging of the amounts of biogas produced,
- shaking the reactors (manually) (→ is the most effective method for very long-fibred samples, e.g. straw or grass),
- and checking the fill levels of the water baths.

After a test measuring time of at least 30 days and reaching the abortion criterion of a biogas growth rate per day of less than 1% of the total biogas volume generated until that point, the tests are aborted.

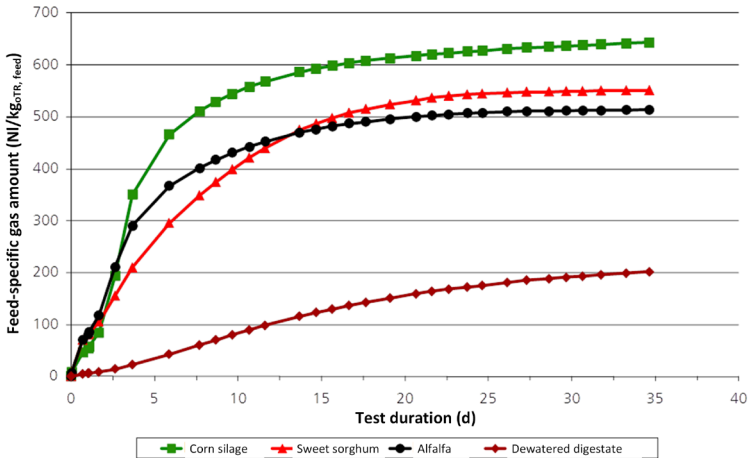

Figure 8.4-2: Batch gas production test - feed-specific gas amounts (Source: IKTS)

The quantification of the components of the produced biogas (gas bag) is carried out with a gas analyser Visit O4 (Eheim company), which determines the oxygen and methane content optically and the carbon dioxide as well as hydrogen sulphide content electro-chemically. The average value is determined for the whole amount of biogas produced, but no temporal progression of the gas quality.

Data analysis

The amount of gas determined by means of a gas meter must be converted to standard volume prior to further analysis (Eq. 91). Complementary to the specifications of the VDI guideline, the impact of the gas volume in the headspace on the measured value of the gas meter in the case of changing barometric pressure conditions is also taken into consideration by IKTS. The volume of the gas phase in the reactor (V_{GP}) is 500 mL for the reactors described here. This volume expands in the case of decreasing barometric pressure or is compressed in the case of increasing barometric pressure. This leads to undesirable fluctuations of the measured values towards the end of the tests (in the case of low gas production rates).

$$V_{STD} = \left(V_c - V_{c-1} - \left(\frac{V_{GP} \cdot P_{c-1}}{P_c} - V_{GP} \right) \right) \cdot \frac{P_c - P_W + P_L}{P_{STD}} \cdot \frac{T_{STD}}{T_c} + V_{STD-1} \quad 91$$

V_{STD} Standardised gas volume mL

V_c Current reading of volume mL

V_{c-1}	Volume of previous day (and/or last reading)	mL
V_{GP}	Volume of gas phase in the reactor	mL
P_c	Current air pressure	mbar
P_{c-1}	Air pressure of previous day (and/or last reading)	mbar
P_W	Partial pressure of water pressure (26.4 mbar at 22 °C)	mbar
P_L	Pressure of the liquid column above the measuring chamber in the gas meter (2 mbar)	mbar
P_{STD}	Standard pressure (1013.25 mbar)	mbar
T_{STD}	Standard temperature (273.15 K)	K
T_c	Current ambient temperature	K

To determine the amount of gas that originates solely from the substrate to be analysed, the standardised gas volume of the reference reactors (inoculation substrate only) is deducted from the standardised gas volume of the sample. For the comparability of the biogas yields to other substrates, a standardisation of the specific biogas amount to the amount of volatile solids is carried out in accordance with the following equation.

$$V_S = \frac{V_{STD}}{VS_s} \quad 92$$

V_S	Specific standardised gas volume, put in relation to the volatile solids	L (STP) $\text{kg}_{\text{ODRecond}}^{-1}$
V_{STD}	Standardised gas volume in the sample	L (STP)
VS_s	Amount of volatile solids in the substrate (input)	kg

In Fig. 8.4-2, the curves of the feed-specific gas production of different substrates are depicted as an example.

The concentration values for methane and carbon dioxide are, in compliance with the VDI guideline, corrected in accordance with Eq. 93 in order to eliminate the impact of water vapour, nitrogen and oxygen from the headspace of the reactors.

$$C_{\text{corr}} = C_{\text{CH}_4 \text{ or } \text{CO}_2} \cdot \frac{100}{C_{\text{CH}_4} + C_{\text{CO}_2}} \quad 93$$

C_{corr}	Concentration of methane or carbon dioxide after headspace correction	%
C_{CH_4}	Measured concentration of methane	%
C_{CO_2}	Measured concentration of carbon dioxide	%

If a sealing liquid gets in contact with the produced biogas during the determination of the amount of biogas produced, it must be kept in mind that gas components can migrate into solution there. Even the acidification of the employed liquids does not prevent the purely physical solution of CO_2 , for instance. In an extreme case, this can have an impact on both the amount as well as the quality of the gas. When using Milligascounter® (gas meters with a low amount of sealing fluid), this effect can be significant for small amounts of gas and should be investigated for each test plant in order to introduce correction factors, if necessary.

It is assumed, that no positive or negative additional effects occur in continuous operation and that a complete mixing state of the reactor content is achieved, so that it is possible to convert the results of the batch tests to continuous conditions. Depending on the number of reactors and their hydraulic retention time, an average gas production can be calculated for each individual reactor via process engineering calculations in accordance with the stirred tank theory. For very long retention times, either an estimation of the further progress of the gas production beyond the end of the batch test must be carried out, or a longer test period has to be selected.

8.5 GRW-Biogas- and Biomethane Potential Test

Nils Engler, DBFZ

Status	Mature/accuracy and reliability approved by frequent participation in round-robin-tests, always passed successfully
Standard	The method is in accordance with the German directive VDI 4630
Area of application	Assessing the specific biogas- and methane yield of organic waste materials and biomass
Disadvantage	High workload for test setup and data acquisition low temporal resolution (1 day), therefore not applicable to assess kinetic parameters
Advantage	<ul style="list-style-type: none"> ● minimal need for sample preparation ● high sample mass per digester ● therefore suitable for very inhomogenous samples (waste) ● due to minimal sample preparation, BMP results are applicable to full scale biogas digesters
Need for research	none
Additionally for methods of batch tests	
Necessary sample preparation	size reduction to < 100 mm
Sample quantities	Up to 2.000 g sample material per digester (equates to approx. 500 g VS)
Special characteristics	Gas volume and composition is logged daily. (regularly workdays) A gas volume of 5 L or higher is required to ensure full accuracy of gas meter. Mixing is performed once per day by magnetic stirrer.
Quality criteria applied	<ul style="list-style-type: none"> ● minimum no. of repetitions: n = 3 ● When relative standard deviation (RSD) within a triplicate exceeds 5% : A Dean-Dixon-outlier Test is performed. ● use of a reference substrate (cellulose)

Devices and chemicals/aids

Modified 30-L-barrels, made of Polypropylene (PP) are used as Batch reactors. Modifications are:

- installing a pivot-mounted magnetic rod at the bottom of the barrel
- installing a ball valve with hose connection at the top

Each digester is equipped with a non permeable gas sampling bag, connected via CPC-couplings. Bags are made of multi-layer material (PP/Aluminum) and dimensioned to capture the gas volume produced by one digester within 2...3 days, which is approx. 40...70 L.

A heating chamber with controlled temperature (range: 25 °C...52 °C, max. tolerance ± 2 K) is used to store the digesters at desired temperature level.

further equipment:

- drum type gas meter type Ritter TG5 (Dr.-Ing. RITTER Apparatebau GmbH & Co. KG)
- multi gas analyser type EHIM VISIT 03 (Eheim Gasmesstechnik GmbH)
- magnetic stirrer type IKA Maxi MR1 digital (IKA GmbH & Co. KG)
- pH meter
- balances (metering capacity 65 kg and 6 kg respectively)

Reagents

Inoculum: digester sludge from anaerobic sewage water treatment is used as inoculum.

Microcrystalline cellulose is used as standard substrate to evaluate the bioactivity and degradation performance of the inoculum.

Nitrogen quality (4.6 or higher) to purge the headspace of the digesters in order to ensure anaerobic conditions from the start.

Sample preparation

Due to the relatively large digester size, most substrates can be tested in their original state. If necessary, size reduction to approx. < 100 mm.

Inoculum must be aged for at least 10 days at 38 °C prior to the test, in order to minimize the background methane production from the Inoculum.

Analysis

Total solids (TS) and volatile solids (VS) content of the inoculum, the tested materials (substrates) and the microcrystalline cellulose is determined prior to the test in order to calculate the required amount of substrate for each digester. Where applicable, TS content has to be corrected, considering volatile organic acids and alcohols (TS_k according to WEISSBACH).

Execution method

All samples as well as the blank test (inoculum only) and the standard (microcrystalline cellulose) are tested at least in triplicates ($n = 3$), if possible, depending on the number of available digesters and the space in the heated chamber, higher numbers of replicates ($n = 6$) are desirable.

According to the directive VDI 4630, the ratio of of the tested substrate and the inoculum, based on VS (Eq. 94) must not exceed a level of 0.4. The desired sample mass per digester needs to be calculated for each substrate to be tested.

$$VS = \frac{m(VS)_{sample}}{m(VS)_{inoculum}}$$

94

For the actual test, all required digesters are subsequently filled. The procedure is for each digester:

- Filling of approx. 20 kg of inoculum into the digester, the actual mass is protocolled.
- Adding the appropriate amount of substrate as calculated, actual mass is protocolled.
- Closing the digester and purging the headspace with nitrogen via the gas outlet port at the top. Purging has to be maintained until the Oxygen concentration in the headspace is below 0.5%.
- Placing the digester in the heated chamber and connecting the corresponding gas sampling bag

In order to eliminate variability caused by inhomogeneity of inoculum during the test setup, it is essential to fill the digesters according to the following pattern:

1. Blank test 1
2. Reference 1
3. Sample 1 / 1
4. Sample 2 / 1
5. Sample 3 / 1
6. ...
7. ...
8. Blank test 2
9. Reference 2
10. Sample 1 / 2
11. Sample 2 / 2
12. ...a.s.o.

The biogas produced by each digester is captured in the gas sampling bags which are deflated regularly, in normal procedure workdays. For this purpose, the respective bag is disconnected from the digester. While deflating, the volume and composition of the produced biogas are measured. Measuring the composition comprises the components CH₄, CO₂, O₂ and H₂S. Together with the volume (measured by a RITTER drum-type gas meter as described above), the gas temperature and pressure have to be protocolled. During the time it takes to inflate the bag, the associated digester is mixed by the magnetic stirrer. Gas

volume and gas composition have to be protocolled and the gas bag has to be reconnected to the digester as soon as possible.

Test duration depends on degradation kinetics of the tested substrates. The test is aborted, when the daily increase of biogas production falls below 1%. This criterion is regularly met after 36 days for by far the most substrates.

To calculate the final results, for each digester the gas volume is converted to volume under normal conditions (273 K, 1013 hPa). Blank tests have to be analysed firstly. As a result, the specific biogas and methane production of the inoculum is known. These values are used to account for the background gas production of each digester according to the respective mass of inoculum. The specific biogas and methane production is finally referred to the mass of sample or the mass VS of sample in each digester. Final results are presented as average values of specific biogas and methane potential in L(STP) per kg VS.

8.6 Determination of the maximum possible biogas output of substrates by disintegration with sodium hydroxide

Björn Schwarz, Fraunhofer IKTS

Status	The method described is based on a regulation from the sewage sludge sector (among others, published through MÜLLER et al. 2000), in which the maximum disintegration potential of sewage sludge is determined via the analysis of the dissolved COD. In this, the samples are diluted 1:1 with 1-molar NaOH and treated for 10 min at 90 °C. This method was transferred to vegetable substrates at IKTS and currently represents an interim processing state.
Area of application	The method can be utilised for the determination of the maximum disintegration potential (release of dissolved COD) as well as for the determination of the maximum possible biogas production from biogas substrates such as renewable resources, residues (e.g. straw) or digestates.
Advantage of the method	The maximum decomposition and/or energy potential possible by means of anaerobic conversion is determined without including fractions that are not biologically available (such as lignin). Any barriers within the substrate structure are removed and all biologically available substrates are made available to be decomposed. The method can easily be carried out as pretreatment method for comparative fermentation tests (low technical expenditure).
Need for research	In the test of model substrates, it was determined that for the framework conditions selected to date for some groups of substances losses in the energy content were caused by the method of disintegration. A possible cause is the generation of biologically non-usable interim products. For real substances, these effects are difficult to estimate due to the heterogeneous composition. To eliminate these uncertainties, systematic investigations in combination with analyses regarding the material composition and structure would be necessary.

Devices and chemicals

- analytical scale
- heatable magnetic stirrer plate incl. magnetic stir bar
- pH-meter
- beaker
- laboratory fume hood
- 1-molar NaOH
- 1-molar HCl (for neutralisation – other chemicals may also be possible)
- distilled water

Execution method

For the determination of the dissolved COD, it is necessary to exactly record – in addition to the empty weight of the beaker – all weighed-in materials as well as the final weight prior to the COD determination so that evaporation and dilution effects are known.

For the determination of the gas potential of the fully disintegrated sample, the amount of sample should fit the size of the batch reactor (gas yield test) in order to avoid unnecessary splitting of samples and losses. In this case, only the exact weight of the sample must be recorded since the added chemicals as well as any evaporation losses do not have any impact on the result of the gas yield test.

The sample and the 1-molar NaOH solution are mixed in the beaker at a ratio of 14 g NaOH solution to 1 g of VS of the substrate (for instance, approx. 63.2 g NaOH [1-molar] to 16.8 g leaves [31.7% TS, 84.4% VS]). For an improvement of the stirrability of the preparation that may be necessary, distilled water can be added (e.g. 20 g). Under constant stirring, the beaker is heated on a heatable magnetic stirrer plate within approx. 15 min to at least 90 °C. A temperature of 90–95 °C is maintained for 20 min. During this disintegration, evaporation losses can be minimised through heat-stable and humidity-stable covers. The vapours generated are potentially noxious and should be exhausted (working under a hood is recommended). Subsequently, the preparation is cooled down to room temperature and neutralised to pH-values of 6–8 by means of 1-molar hydrochloric acid.

The analysis of the dissolved COD is performed through pressure filtration of the sample via 0.45 µm as well as by means of cuvette tests.

For the determination of the gas yield, the complete preparation is transferred timely into a batch reactor. To minimise losses, a flushing with a small amount of distilled water can be performed.

Sample results and open questions

Via an analysis of the development of the gas yield graphs, it can be determined whether it is worthwhile to carry out a substrate pretreatment for the substrate being tested. By means of a disintegration via NaOH, for example, only an acceleration can be observed in Fig. 8.6-1 for maize silage after a 30 d retention time, but no increase in yield. This roughly corresponds to the results of numerous tests regarding the pretreatment of maize silage that did not achieve significant rates of increase under the ideal conditions of the laboratory fermentation tests. For the disintegration of straw, on the other hand, it was possible to achieve a significant improvement of the gas production velocity and yield. This is a clear indication of the aptness of disintegration methods in the area of residues containing lignocellulose.

But generally there are still uncertainties in the interpretation of the effects of the disintegration by means of NaOH since obviously lower gas yields are obtained for select groups of substances than without the disintegration. One example is the micro-crystalline cellulose, which is also depicted in Fig. 8.6-1. Subsequent to the disintegration by means of

NaOH, about 10% lower gas yields are obtained which also were evident in case of shorter treatment times and in case of lower utilisation of NaOH. A return of condensed vapours produced during the disintegration led to the same result. Possibly, individual groups of substances or components of them are converted into no longer usable interim products during the disintegration. Tests with peptone (protein model substrate) and glucose have also resulted in reductions of approx. 15% and 50% regarding the gas yield by the disintegration by means of NaOH. To which extent these reductions also occur in real substrates has not been investigated yet systematically.

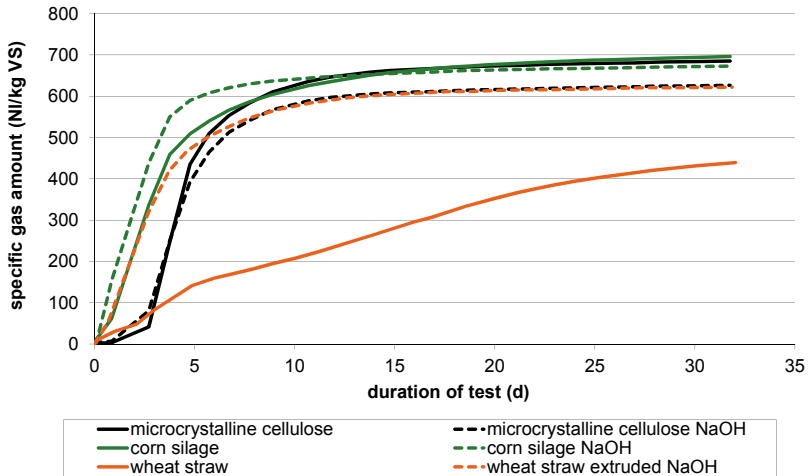

Figure 8.6-1: Sample gas yield graphs before and after a disintegration by means of NaOH (Source: IKTS)

8.7 Design of an Anaerobic Dry Batch Digestion Pilot Plant System with Provisions to Simulate Full Scale Conditions

Earl Jenson, Alex Hayes, Steve Mervin, Sylvanus Ekwe, InnoTech Alberta

Status	This method has been used numerous times for material evaluation but is still new and developing.
Standard	No direct standard exists but several complimentary standard methods are applicable for many of the measurements.
Area of application	Directly applicable to material targetted for dry batch digestion.
Disadvantage of the method	A significantly laborious method that required substantial amounts of material and it may take more than one cycle to achieve results for a new material.
Advantage of the method	It reasonably simulates full scale operations and provides detailed information not always available from full scale operations.
Need for research	More research is required to understand and possibly improve the compression method that simulates material height and a better means to re-establish percolate flow if blockages occur, is needed.
Additionally for methods of batch tests	
Necessary sample preparation	Material must be premixed.
Sample quantities	Sample quantity requirements are nearly 500 L per reactor
Special characteristics	none
Quality criteria applied	none

Dry batch digestion is a relatively new style of anaerobic digestion process that has been steadily commercialized over the last fifteen years. This style of digestion involves loading solid organic feedstock mixed with a solid inoculum into garage-style units, typically with a wheel loader, where the substrate is piled as high as 4 meters. Once loaded, the digester is sealed and digestion begins. Leachate from the feedstock is collected in a liquid digester and sent back to the top of the substrate pile where it percolates through the substrate to improve the kinetics of the process. Dry batch digestion is well suited to handle materials that are too dry in nature to flow through pumps and/or highly contaminated with materials that detrimentally impact the performance of traditional wet digestion systems such as single-use plastic, broken glass and woody biomass. However, since percolation plays such an important role in the process, substrate permeability and porosity play a critical role in digester performance. Additionally, issues of compaction, grit movement and accumulation within the substrate, and percolation rates all influence the overall porosity. Beyond these rather physical features, quantities of inoculum or recycle used within the dry batch digestion process and retention time also play a significant role in system operation, reactor efficiency and process stability.

Coupled together the overall interactions of these numerous parameters makes the dry batch system highly variable, complex and worthy of study. To further understanding and develop guidelines for dry batch anaerobic digestion system operation a pilot plant was constructed at InnoTech Alberta to facilitate the testing of numerous substrates under various process and operating conditions. The pilot plant was designed such that many of the parameters could be controlled and measured under near industrial conditions and of such a size that many scale related issues were minimized. The section on "Sample Pilot Plant Trial Data" in this chapter contains a sample of the data collected from the pilot plant during one trial or operational period of the system.

Equipment Description

Dry Batch Pilot Plant

The dry batch anaerobic digestion pilot plant system consists of two ~500 L working volume stainless steel dry digesters (primary chamber: 60.9 cm wide, 76.2 cm high & 152.4 cm deep) and an adjustable working volume (~150 L to 350 L) (76.2 cm diam., 90 cm high) percolate digester (Fig. 8.7-1). The dry digester reactors are constructed with a slight slope towards a sand trap located beneath a grating at the far end of the vessel interior. The top and front covers of the dry digesters are removable via bolted and gasketed flange connections to facilitate easy loading and unloading. The pilot plant operation and data collection is automated with gas production, gas composition, pH and temperature measurements collected and schedule based control of pumps and heating etc. provided through a central PLC and human machine interface (HMI) configuration. The schedule of activities such as percolation times, process temperature, percolation rates and amounts are all controlled through the HMI settings. The system is designed to simulate the operation of a typical full scale industrial dry batch digestion process.



Figure 8.7-1: Dry batch digestion pilot plant at AITF. The pictures show the front of the system (left) and back (right) with a round percolation digester in the back (Source: InnoTech)

The digesters are insulated and jacket heated with electric heating pads to maintain temperature as measured by industrial thermocouples within the vessels. Digester pH is continuously monitored in the dry digesters with industrial Endress and Hauser (E&H) pH probes located in the liquid (top) portion of the sand traps. The liquids in this region are liquids that have recently drained through the material in the dry digester so it is representative of the material in the digester.

The percolate or leachate returning to the percolation digester from each dry digester passes through a flow meter that monitors the returning flow rate and amount. Percolation digester samples and dry digester leachate samples are taken from the process as required by harvesting samples from the base of the digesters where sample valves are located. The percolation digester is mixed by a recirculation pump. Within the recycling piping an Endress and Hauser pH probe is installed to monitor pH of the percolation digester. Percolate is transferred to the dry digester with a peristaltic metering pump that pumps the percolate into a distribution header in the top portion of the dry digesters. The PLC system triggers a series of valves and timers to control when and how much percolate is supplied. The distribution header consists of a perforated stainless steel plate (visible in Fig. 8.7-1 left) with raised perforations and a tipping tray that floods the header rapidly after each tip such that uniform percolate quantities shower through the perforations onto the substrate below. Percolate that leaches through the substrate drains through the floor grate into the sand trap and then gravity flows through a filter and inline flow meter before draining back into the percolate tank. The percolation digester is situated lower than the dry batch vessels to facilitate the gravity flow. The percolation digester height along with the dry digester height can be adjusted to control operational levels of the percolate tank. The percolation digester also has a level indicator so overall percolate return can be monitored.

Biogas produced by each digester first passes through a cooling zone (room temperature piping) to condense a portion of the moisture and then moves through a Ritter rotary flow meter. The gas is then routed through a gas monitoring system for gas compositional analysis via chromatography. Methane gas concentration along with carbon dioxide, hydrogen sulphide and combined nitrogen-oxygen concentrations are measured by a Micro-GC (Galvanic Applied Systems). An overall process schematic is shown in Fig. 8.7-2.

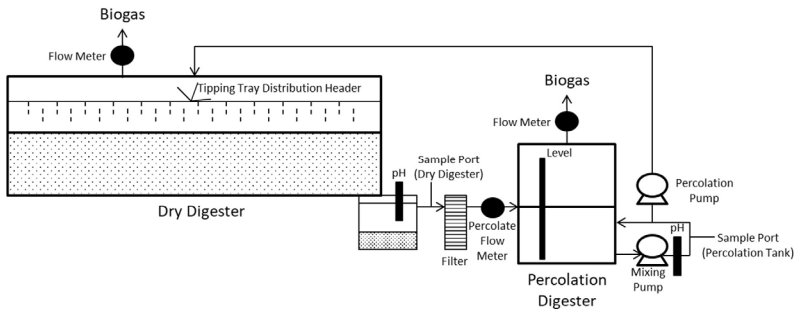

Figure 8.7-2: Overall process schematic (Source: InnoTech)

The small height of the pilot scale reactors does not adequately represent the pressure from the height of the material in a full-scale system. This has been simulated in the dry digester pilot by force applied with a steel grating to the substrate (Fig. 8.7-3). The steel grating is pulled downwards by metal rods that pass through the substrate and digester floor where they are attached to a pneumatic piston. The force applied by the pneumatic piston is adjusted by controlling the supply air pressure to the piston. Once the desired set force is achieved the grating is left to apply the constant force during the entire test period much like substrate above applies force on substrate below in full height situations.



Figure 8.7-3: Pneumatic piston beneath dry digester and grating pulled down onto material to simulate pressure from material height inside the bunker (Source: InnoTech)

Bunker Aeration for In-vessel Composting

In-vessel composting trials at the end of dry anaerobic digestion trials have been facilitated in the vessels by installing aeration piping prior to loading the substrate (Fig. 8.7-4). The aeration header consisted of 5 lengths of 9.5 mm (I.D.) PVC pipe spaced evenly across the vessel floor, drilled with 1.6 mm diameter holes alternating every 75 and 150 mm along the lengths of the pipe. The supplied air was from the building instrument air supply and was regulated by a standard Rotameter. The aeration header was sized such that air rates up to $51 \text{ m}^3 \text{ h}^{-1} \text{ m}^2$ of bunker floor area and/or $15.9 \text{ m}^3 \text{ h}^{-1} \text{ m}^3$ of bunker operating volume could be supplied. These rates are used in some full-scale operations. Our experience has shown that applying aeration based on the vessel volume is a more appropriate means to scale the process and humidification of the aeration supply air will likely be necessary.

Substrate Preparation

Premixing of materials processed in the dry digesters was conducted in a Marion paddle mixer (Fig. 8.7-5) with an operational batch capacity of $\sim 300 \text{ L}$. Materials for each batch were weighed and added to the mixer according to a predefined recipe. The combined feed-stock was dumped into 60 L totes for transfer to the dry digester pilot plant.



Figure 8.7-5: Paddle mixer used to prepare substrate mixtures for dry digestion (Source: InnoTech)

Limitations and Future Improvements

After three years of operation some limitations of the pilot system have been observed. The most prominent issue is plugging of the grated floor where leachate leaves the vessel and enters the sand trap. Although this is an indication of material deficiencies, it is not the same issue as an overall plugged material matrix which could be a full-scale system issue. Full scale systems generally have significant floor drainage systems that are less likely to experience blockage. To remedy this a perforated pipe matrix is laid on the vessel floor prior to loading which offers many more drainage paths to the grated floor section (Fig. 8.7-6). However, this is not the most ideal situation and other modifications should be explored. Additionally, physical scratching/agitation of the material compressing into the floor grating has been undertaken on occasion during an active process via a curved bar passed up through the sand trap to the grating. A provision that included a means to mechanically agitate the floor grating area to disrupt blockages so percolate can flow through the system would be a desirable add on feature.

A secondary add-one issue observed in the system involves the unit with the compression system. We believe the interface between the grating that pulls down on, and compresses the material has a much more prominent sealing effect than material that is just experiencing compression from a gradual weight increase associated with the material height. To overcome this sealing interface pieces of PVC pipe (36 mm diameter, 150 mm long) have been installed vertically beneath the grat-



Figure 8.7-4: Aeration header in the base of the dry digester converted for use as an aeration bunker, the vertical rods for the substrate compression system are also visible (Source: InnoTech)

ing into the top of the material to act as drainage channels through the sealing interface (Fig. 8.7-7). The results of this modification are inconclusive to date, but we believe some level of modification such as a coarser compression grating or other modification is warranted.



Figure 8.7-7: Pipe segment drainage channels placed and installed beneath the grating (Source: InnoTech)

Finally, one must be cognizant of the piping runs and filter system chosen for the percolate return because considerable amounts of grit are in the percolate that can drop out of suspension and create blockages. The percolate flow meter style should be an inline style with no restrictions, but it is challenging to find a unit that is full port, and large enough such that blockages are not an issue but can still measure the wide range of percolate return flow rates, especially once the leaching or draining process becomes partially impaired and flow rates reduce.



Figure 8.7-6: Dry digester pilot vessel with slotted PVC piping on the floor and the floor grating in the background. The rods that pull down on the compression grating system are also visible (Source: InnoTech)

digesters and the percolation digester over the trial duration (in some instances data from the second dry digester (Digester 2 or D2) is also shown).

Fig. 8.7-16 shows the digester contents after the front and top panels were removed from the digesters at the completion of the trial.

Sample Pilot Plant Trial Data

The following data was produced during a trial that utilised a mixture of dairy manure, wood chips, straw, and inoculum (residuals from a previous trial) for the feedstock. Fig. 8.7-8 to 8.7-15 show the biogas production, compositional data and percolate data from one of the two dry

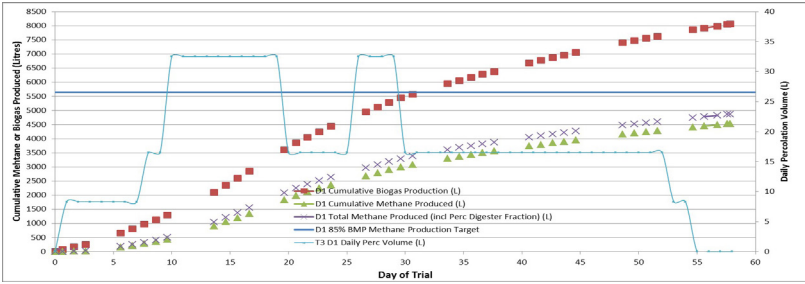

Figure 8.7-8: Cumulative biogas and methane production, daily percolation volumes and an 85% of biomethane potential target marker (based on feedstock BMP) for Digester 1 throughout the Trial (Source: InnoTech)

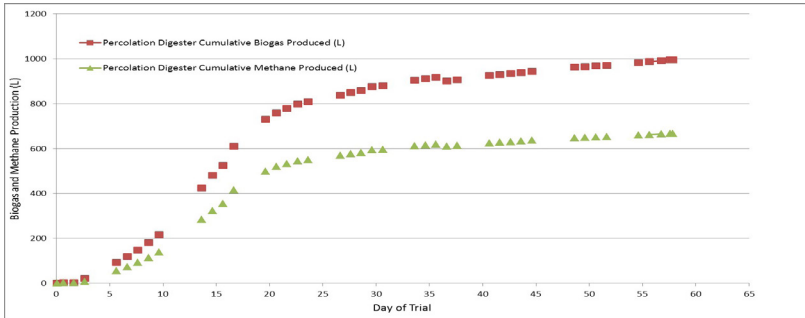

Figure 8.7-9: Cumulative biogas and methane production from the percolation digester during the Trial (Source: InnoTech)

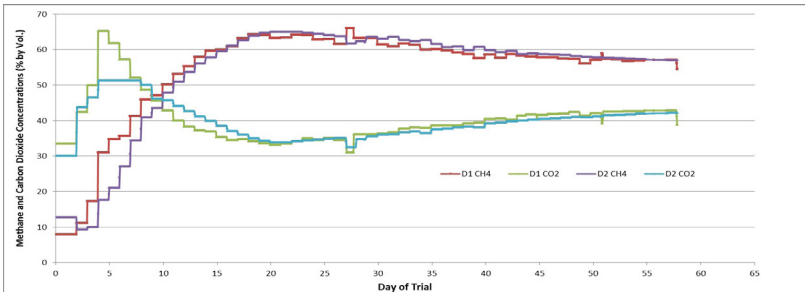

Figure 8.7-10: Biogas compositional data from Digester 1 and 2 throughout the trial (Source: InnoTech)

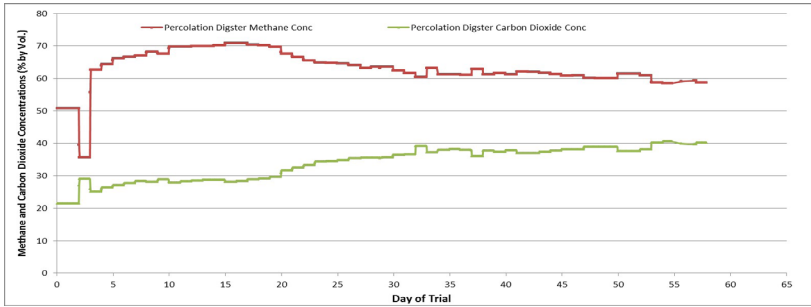

Figure 8.7-11: Biogas compositional data from the percolation digester throughout the trial (Source: InnoTech)

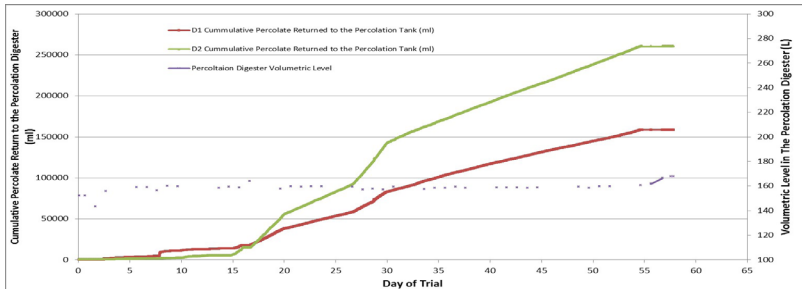

Figure 8.7-12: Cumulative percolate returned to the percolate digester from dry Digesters 1 and 2 and percolate volume in the percolate digester throughout the trial (Source: InnoTech)

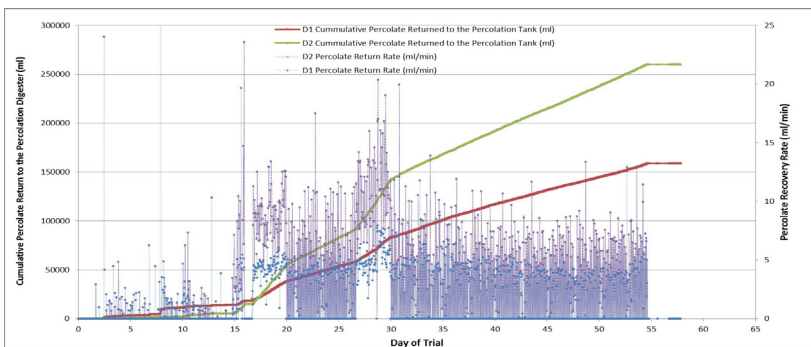

Figure 8.7-13: Cumulative quantity and rate of percolate returned to the percolate digester from dry Digesters 1 and 2 throughout the trial (Source: InnoTech)

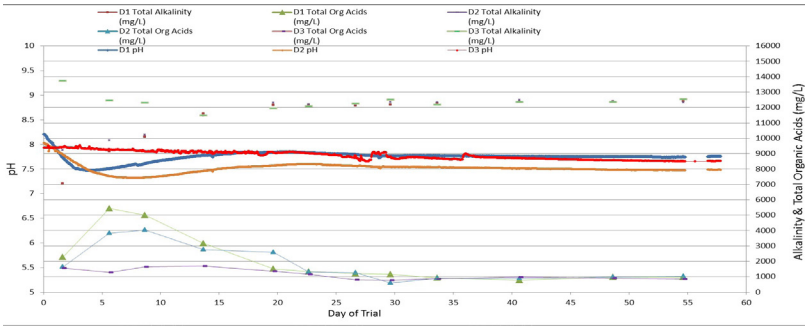

Figure 8.7-14: Total alkalinity, total organic acids and pH for the percolate digester and dry Digesters 1 and 2 during the trial (Source: InnoTech)

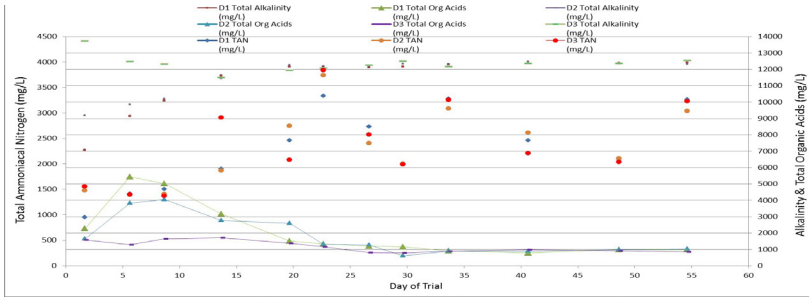

Figure 8.7-15: Total alkalinity, total organic acids and total ammoniacal nitrogen for the percolate digester and dry Digesters 1 and 2 during the trial (Source: InnoTech)



Figure 8.7-16: Digester 1 and Digester 2, open at the end of the trial with post digestion contents visible (Source: InnoTech)

8.8 Specific activity-, toxicity- and supplementing test (ATS) for the optimization of the facility management of biogas plants

Mathias Hartel, Bavarian State Research Center for Agriculture

Status	Not yet validated house method for determining the fitness of a biocenosis from biogas plants by means of a mini-batch system (ATS).
Standard	None
Area of application	Biocenoses from biogas plants in combination with agricultural substrates and waste material, as well as mineral and biological additives and/or concentration-dependent single substances
Disadvantage	Time-consuming determination of gas quality
Advantage of the method	Compared to the interpretation of the time-consuming laboratory chemical methods for manure, it is possible within a few hours to a few days to make concrete statements about the degradation kinetics and effect of a selected substrate delivery or single substance with respect to a selected biocenosis. The method allows a simultaneous test of eleven variants with triplicate repetitions. In practice, this method may contribute to determining the fitness of a digester and support faster and thus more flexible decisions in the management of a biogas plant.
Need for research	Dose - response ratio of toxins, interactions with other ingredients

The activity-, toxicity- and supplementation test (ATS) was developed within the framework of several research projects at the Institute of Agricultural Engineering and Animal Husbandry of the Bavarian State Research Center for Agriculture and is based on the detection of gas formation in a mini-batch process. The test should allow the quickest possible conclusion on the fitness of the fermenter biology of different fermentation mixtures with regard to the feasibility of substrates and substances. In this way, the information of an intact or imperfect biocenosis should be presentable. Further more, within a few hours to days, information on the activity and resilience of the microorganisms by substrate-specific properties should be possible. An illustration of the biogas potential of substrates or substances should not be the aim of this test. Rather, depending on the biocenosis and the substrate used, an evaluation of the biogas process should be carried out on the basis of the respective degradation kinetics.

The mini-batch system is arranged in a constantly heated water bath (25 °C to 70 °C ± 0.02 °C). The design makes it possible to swivel a maximum of 33 bottles for controllable interval or continuous operation in a variably adjustable speed. Compared to the Oberhausen-Rostock-Göttingen activity test (ORGA test) (ENGLER et al. 2011), dilution is not required to ensure stirrability by using a magnetic stirrer. In Comparison to the ORGA test smaller, 250 mL bottles (Duran® pressure plus laboratory glass bottle GL45, Schott,

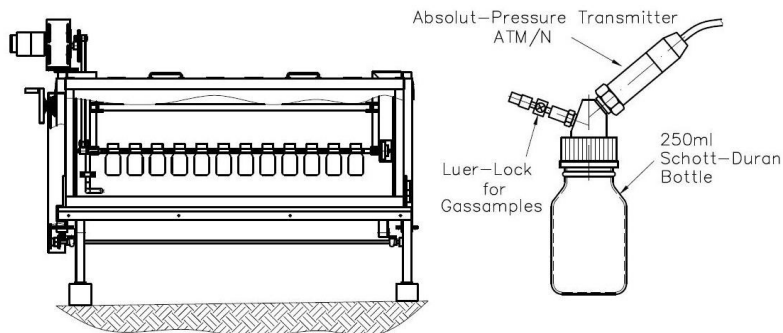

Figure 8.8-1: Left side: Schematic structure of the water bath (left) with swivel mechanism. Right side: Schematic structure of the test bottle with ATM / N pressure transmitter and device for sampling from headspace volume

Mainz, DE) are used as sample containers. On the specially developed bottle cap, an absolute pressure transmitter (ATM/N, STS, Sirmach, CH) and a Luer stopcock with screwed-on injection cap are attached to each bottle for the removal of gas samples (Fig. 8.8-1).

Due to the pressure transmitter, it is possible to detect even the smallest pressure changes of approx. 5 mbar. The bottle cap and lid are designed to guarantee a gas tightness of 10 mbar L s^{-1} . The absolute pressure transmitter enables continuous quantitative recording of biogas production. With the help of the software LabView (LabView 8.6, National Instruments, Austin, USA), the pressure development in the individual bottles, room temperature and temperatures in the water bath are averaged, recorded and stored within an interval of 10 min each. Since the measuring range of the absolute pressure transmitter as well as the maximum pressure in the batch bottles only reaches an absolute pressure of 2.25 bar, the pressure must occasionally be drained from the bottles. At these times, the qualitative determination of the gas composition takes place via the manual removal of gas samples via the Luer stopcock and a subsequent analysis on the micro-gas chromatograph (3000 Micro-GC, Agilent, Santa Clara, USA). This enables the qualitative detection of methane (CH_4), carbon dioxide (CO_2), oxygen (O_2), nitrogen (N_2), hydrogen sulphide (H_2S) and hydrogen (H_2) compared to the ORGA test.

Fig. 8.8-2 shows a part of the pressure recording of an active experiment. The green line marks the ambient pressure, the red line the maximum permissible pressure of the batch bottles for experiments. In between, the currently measured pressure of the pressure transmitter is visible as a point for each measuring point. In total, 33 batch bottles can be clamped in a water bath. The measuring points 34–36 shown in the software are additional pressure transmitters which can be used as a replacement in case of failure of a pressure transmitter in use.



Figure 8.8-2: Part of the screenshot to record the existing pressures at the individual measuring points. Green \triangleq Ambient pressure, red \triangleq Perm. Max. Pressure. Blue corresponds to the prevailing pressure at each measuring point

Experimental Setup

The standard biocenosis SB2 (described in more detail in HEUWINKEL et al. 2009) used at the institute is optimally supplied with an organic loading rate (OLR) of $3.0 \text{ kg}_{\text{VS}} (\text{m}^3 \text{ d})^{-1}$ and operated under constant steady state conditions for several years. For these reasons, the SB2 at the ILT is mainly used to determine the potential of biogas production under standard conditions (standard batch experiments). After removal of the inoculum, sift and homogenise with a 10 mm sieve. As a result, especially large-fiber fractions are removed, which would complicate an accurate weighing. In addition, a possible influence on the upcoming fermentation test by heterogeneously distributed, coarsely fibrous fractions can not be excluded. To analyse the contents of the inoculum, a sample amount of 1 L is taken and analysed. Into each bottle an amount of 100 g of inoculum is weighed (accuracy of $\pm 0.05 \text{ g}$). the inoculum without any other substrates added, is used as blank. The procedure for the use of fermentation mixtures from parallel projects or industrial scale biogas plants is analogous.

Depending on the question, agricultural substrates or residual substances are added as a stress test or single substances in the desired concentration immediately before the experimental trial. Mixing is accomplished by gently swivel the batch-bottles. Immediately thereafter, the lid of the batch bottle is put on, the headspace is carefully nitrogen-purged and the bottle is closed as tightly as possible. All experiments are carried out in a randomised form in triplicate.

Current state and research needs

The evaluation is based on the relative biogas production to the control and the course of the pressure curve. The specific biogas production of the substrate by a biocenosis occurs during the course of the pressure curve. Depending on when the slope of the pressure curve changes or if it changes at all, there may be indications of an increased or inhibited biogas process. In addition, informations for increasing or inhibiting the biogas process by the influence of a particular substance can be mapped to a particular biocenosis.

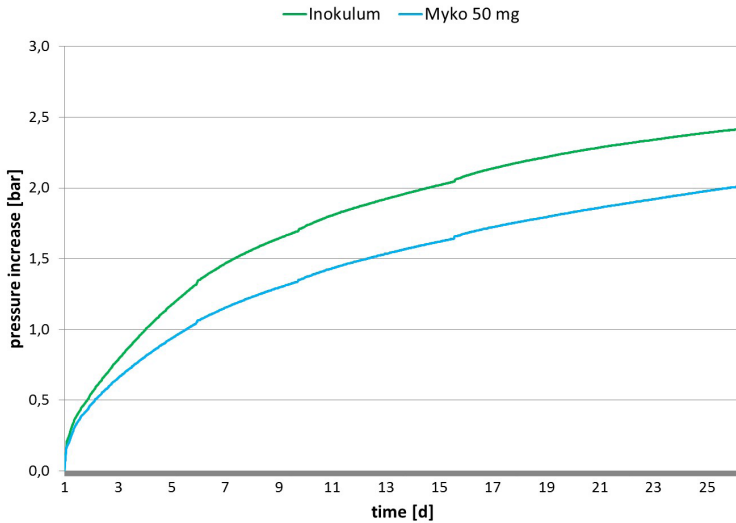

Figure 8.8-3: Averaged pressure course of the biocenosis SB2 after addition of 50 mg mycophenolic acid (Myko 50 mg)

Fig. 8.8-3 shows the pressure course of a biogas process inhibited from the beginning after addition of mycophenolic acid in a concentration of 50 mgL^{-1} . By using the standard biocenosis SB2, which is considered to be stable, an already malfunctioning biocenosis can be excluded, so that the reduced pressure development is probably due to the addition of mycophenolic acid.

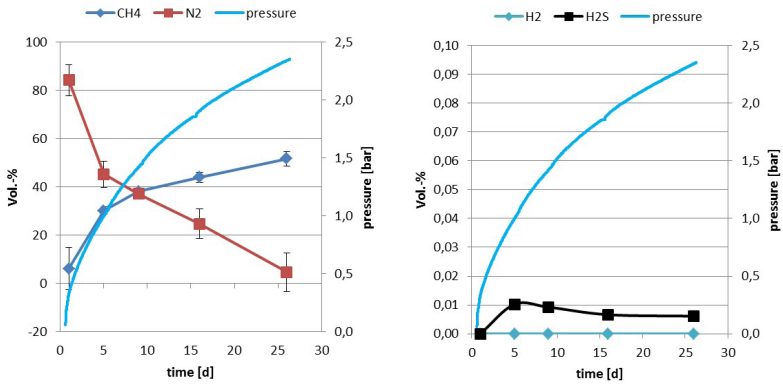

Figure 8.8-4: Methane and nitrogen content course (left) and hydrogen and hydrogen sulfide content (right) during the course of the experiment after 50 mg L⁻¹ mycophenolic acid for biocenosis SB2

In Fig. 8.8-4 of the associated course of the nitrogen and methane content, as well as the hydrogen and hydrogen sulphide content during the course of the experiment of 26 days do not indicate any evidence of a malfunctioned process condition. The high nitrogen content at the beginning of the experiment is due to headspace flushing at the start of the experiment. Thus, additional microbiological and laboratory analyses may continue to be helpful for interpretation. A dose-response relationship due to the high complexity of biological processes in the biogas process can not be derived with this methodology. Likewise, long term adaptation of microorganisms to e.g. regular substrate change by methodology is not representable.

In cooperation with current projects, it was possible to use practice-relevant digester contents in the ATS system and to test their reaction. In contrast to the standardised batch method, it was possible to provide a relatively quick statement on the fitness of a biocenosis with regard to an increase or inhibition of biogas production. Additions can be made in different doses or concentrations. Thus, the ATS-system offers an advantageous possibility, for example, to add toxins in different concentrations directly into the fermentation medium. The extraction of such pure substances is very complex and costly and constitutes under natural conditions already in the μl range high dosages. Accordingly, larger-scale experimental setups using larger amounts of fermentation substrate for these tests are less suitable. On the one hand, non-automated gas analysis offers the possibility of being able to measure the smallest gas quantities as needed. On the other hand, the analysis and evaluation by the necessary preparatory processes is very time-consuming, so that a maximum of 25 gas samples per day can be measured.

8.9 Determination of the residual gas/residual methane potential

Hans Oechsner, State Institute of Agricultural Engineering and Bioenergy, University of Hohenheim

Status	The method was tested, and a standard is currently under development as a part of the VDI GUIDELINE 4630 (2016). An interlaboratory comparison is currently taking place for the validation of the method.
Standard	VDI 4630
Substrates	The method is applicable for solid and liquid digestate.
Limitation of the method	The setting in relation to an amount of methane generated presupposes the estimation of digestate mass flows and biogas yields at the biogas plant.
Advantages	Easy to implement
Need for research	Relation between the residual gas potential and emissions in the case of open storage of digestate (i.e. fermentation residue); precise mass balance of substrates. A study by RUILE, et.al 2015 shows exemplarily the influencing factors on the residual methane potential in practice biogas plants.

The biogas plants, in which renewable bioresources are used as feedstock (i.e. substrate plants for fermentation), seek to explore ways in achieving economic viability and maximizing the utilisation of the energy potential of the feedstocks. Biogas plants select the fermentation process (i.e. plant design and operation mode) depending on the characteristics of the feedstocks used. The feedstock utilization rate varies significantly with the design (e.g. single stage and double stage) and operational parameters (e.g. pH, temperature, organic loading rate, and retention time among others).

The following questions can be answered by determining the residual gas potential of the digestate from the biogas plant:

- How much biogas/methane potential of the substrate is not utilised following the digestate leaving the gas-tight section of the biogas plant?
- How much economic benefit (if any) does the cover of the digestate storage unit have?
- How large are the maximum emissions potential and the corresponding environmental impact? For additional information, refer to VDI guideline 3475, part 4.

Depending on the objective of the analysis, the digestate sample could be incubated at different temperature:

- To determine an available energy potential (i.e. economic aspects), the fermentation of the digestate at a mesophilic temperature ($37 \pm 2^\circ\text{C}$) or at a thermophilic temperature ($50 \pm 1^\circ\text{C}$) is recommended. If possible, a temperature range should be selected based on the operating temperature of the fermenter from which the digestate sample was collected. Operating at similar temperature allows a rapid gas production, which is comparable to the gas production from the substrate in the fermenter from where the digestate sample was taken.
- In accordance with VDI 3475 part 4, the residual gas potential of the digestate can also be estimated at $20 \pm 2^\circ\text{C}$. Additionally, this can be used to determine the emissions potential, given that the digestate are stored in an open and cold storage tank. Therefore, it is assumed that lower temperature prevail in digestate storage units than in fermenter systems. However, currently there is no any scientific evidence that establishes a close relation between residual gas potential measurement and the actual emissions from the digestate of the evaluated plant.

Sampling from the biogas plant and data collection

The digestate samples must be collected from the biogas plant in order to determine the residual gas potential. This method requires diligence and compliance with the following procedures in order to obtain representative digestate samples for the selected biogas plant. The digestate that leaves the last fermentation stage may, depending on the mode of operation and the feedstock used, be inhomogeneous and may also vary over the course of time. Therefore, the sampling should not be conducted only at a certain point of time, but rather for multiple times per day (e.g. three times). Additionally, it should preferably be for various days over the week. If it is not possible, for technical reasons, to withdraw samples at multiple times over a day or week, the fermenter content must be thoroughly homogenised prior to the retrieval of the sample. It is also possible to analyse the digestate from solids fermentation plants and the freshly separated solids from liquid fermenters. In the case of the latter, however, the substrate flow must be thoroughly recorded in order to make a statement about the digestate generation potential of the biogas plant. Immediately after its retrieval, the digestate sample must be cooled to a temperature of approximately 4°C (not frozen!). Such cooling will quickly stop any further decomposition of the digestate. Later, the digestate samples which are collected multiple times over a day or week are mixed together to create a cumulative sample. If sample contains fibre components, a coarse cutting/crushing can ensure that a homogeneous and representative sample is available for the fermentation test.

The residual gas potential is usually based on the amount of biogas and the methane yield of the biogas plant in a stationary mode of operation. Therefore, in addition to taking digestate samples for analysis, the amount of biogas and methane generation at the plant must also be recorded. Besides, the results of the digestate analysis must be put in relation to the volume of the digestate flow. Thus, it is necessary to determine the volume of digestate that leaves the plant section under review (i.e. over flowing fermentation mixture/

fermentation residue). The sample of the fermentation mixture (i.e. digestate) represents a mixture of a long period with respect to the feeding. In the case of stirred tank reactors, an approximation of the stationary state is achieved after approximately three hydraulic retention times. It is therefore recommended that the data from three hydraulic retention times be used to calculate an average amount of gas and digestate produced per day.

The volume of fermentation mixture/digestate can be determined through calculation if the measuring equipment does not quantify it. For example, the mass of input substrate (i.e. mass flow of substrate into the biogas plant) and the mass of the biogas produced are recorded. Later, the mass of the biogas generated is subtracted from the mass of the input substrate to derive the amount of the fermenter content/digestate (see in text below). The loss of mass caused by the biogas production should not be neglected since it can, for example, constitute up to 30% of the input mass flow in the case of maize silage.

Fermentation approach

The representative substrate sample is analysed for the content of dry solids and volatile solids. Furthermore, the pH value and the content of volatile fatty acids must be determined. The substrate is added in no less than three repetitions in the required amount to the fermentation test apparatuses without the addition of inoculum.

If fermentation residue from solids fermentation plants and solids are to be analysed after separation, a mixing with tap water is necessary in order to obtain a DS content in the mixture of no more than 10%. The addition of water is necessary in order to obtain an optimally fermentable and stirrable mixture in the fermentation test apparatus. The fermentation test apparatus is heated to the desired temperature level and the biogas generation starts. In the execution, the same conditions as for the batch fermentation test method must be adhered to with respect to constant temperature and homogenisation. At each gas withdrawal, in addition to the amount of gas, the methane content must also be recorded in order to allow for a statement regarding the temporal development of the gas generation. The fermentation test for the determination of the residual gas potential should be carried out over a defined period of time of 60 days, as is also stated in VDI GUIDELINE 3475.

Analysis:

The data analysis can be conducted analogous to the batch fermentation test. It is simplified by the fact that no inoculum is being used. A gas generation graph should be created on which the development of the specific biogas/methane generation over the test period is displayed.

As result, the methane yield from the fermentation residue in L a.s.c. methane kg^{-1} oDS is stated, which of course produces lower values than the methane yield in crude substrate. A reference to the average amount of methane generated daily of the practice biogas plant from which the fermentation residue sample originates completes the analysis. Since a reliably functioning system for the determination of the gas amount and gas quality does not exist at all biogas plants, the amount of electricity produced on average per day can be utilised for estimating the amount of methane generated at the biogas plant. The latter must be combined with the efficiency of the CHP in order to obtain the amount of methane utilised daily. In this simplification, amounts of gas that are passed via the excess gas burner are not taken into consideration; therefore, this leads to a corresponding overestimation of the residual gas potential.

The following data of the biogas plant to be analysed must be determined:

- Biogas/methane production of the practice biogas plant over a period of three retention times. This is done through data capture at the biogas plant (standard biogas amount, methane content) [m^3 a.s.c. methane d^{-1}].
- Alternatively, the daily electricity production in [kWh d^{-1}] can be recorded for estimating the amount of methane. Its combination with the electrical efficiency of the CHP results in the daily methane yield in [m^3 a.s.c. methane d^{-1}].
- Daily discharge of fermentation mixture and its oDS content from the respective last gas-tight covered fermenter/fermentation residue storage unit [t fermentation residue * oDS [%] / 100]. The mass flow can be estimated via the mass of the substrate input (liquid and solid substrates) less the mass of the biogas produced

Calculation

$$m_D = m_S - m_{BG} \quad [\text{m}^3] \quad 95$$

m_D	Average mass flow of digestate per day	kg d^{-1}
m_S	Average mass flow of substrate input per day	kg d^{-1}
m_{BG}	Average mass flow of the biogas generated per day ($m_{BG} = V_{BG} \cdot \rho_{BG}$)	kg d^{-1}
V_{BG}	Biogas rate, standardised volume of the biogas generated per day	$\text{m}^3 \text{ (STP) d}^{-1}$
ρ_{BG}	Density of the biogas (= 1.25 kg m^{-3} at 55 % methane content, dry gas, standard conditions)	kg m^{-3}

These data are put in relation to the following values determined in the fermentation test: Specific methane yield from the residual gas analysis in m^3 (STP) methane kg^{-1} VS.

$$V_{RG} = V_{SRG} \cdot VS_{RG} \quad [\text{m}^3] \quad 96$$

V_{RG}	Average methane potential of the digestate from the biogas plant per day	$\text{m}^3 \text{ (STP) d}^{-1}$
V_{SRG}	Specific methane yield from the residual gas analysis	$\text{m}^3 \text{ (STP) kg}^{-1} \text{ VS}$
VS_{RG}	Average amount of volatile solids that exit the last gas-tight tank of the biogas plant per day	kg d^{-1}

From this the residual gas potential of the biogas plant in [%] is determined using the following formula:

$$\text{RGP} = \frac{V_{RG}}{V_{BGP}} \cdot 100 \quad [\%] \quad 97$$

RGP	Residual gas potential	%
V_{BGP}	Average methane production of the biogas plant per day	$\text{m}^3 \text{ (STP) d}^{-1}$

8.10 Gravimetric measurement of BMP

Sasha D. Hafner, Aarhus University; Brian K. Richards, Cornell University, Ithaca, Sergi Astals, University of Barcelona

Status	Validated by comparison to volumetric or manometric results in three laboratories (US, DK, AU)
Standard	None
Area of application	Batch biogas production from any reference substrate/waste material
Disadvantages	Lower sensitivity than manometric methods, more effort than automated methods (e.g. AMPTS II)
Advantages	Not sensitive to leaks (which may be a common problem with volumetric methods), not sensitive to CO ₂ dissolution/volatilization (contributing to better accuracy than manometric methods), not sensitive to headspace volume, not sensitive to errors in headspace pressure or temperature, less effort than manual volumetric and manometric methods, less sensitive to measurement or recording errors
Need for research	Refinement to eliminate need for biogas composition analysis is a current research topic. Additional testing with different materials would be useful.
Additionally for methods of batch tests	
Necessary sample preparation	As with any batch BMP test, e.g. HOLLIGER et al. (2016), VDI (2016) or see Section 8.5 (ENGLER) and 10.3 (LIU)
Sample quantities	As with any batch BMP test, e.g. HOLLIGER et al. (2016), VDI (2016) or see Section 8.5 (ENGLER) and 10.3 (LIU)
Special characteristics	Biogas production measured by mass loss, separate composition measurements required
Quality criteria applied	As with other batch BMP methods, typical BMP criteria may be applied, e.g. HOLLIGER et al. (2016) or VDI (2016)

Theory and background

The biochemical methane potential (BMP) test is used by both academic and technical practitioners to determine the maximum attainable methane (CH₄) yield from a given organic substrate (RAPOSO et al. 2011; HOLLIGER et al. 2016). The main product of a BMP test is the cumulative methane production curve over time, from which the maximum methane yield (the potential) and substrate degradation kinetics can be obtained. BMP tests are commonly carried out by volumetric or manometric (pressure-based) methods. However, as shown in this chapter, BMP tests can also be carried out gravimetrically (based on mass measurements), which has some advantages over volumetric and manometric methods.

As with all matter, biogas has mass, so releasing the biogas from a BMP test bottle results in a decrease in the mass of the bottle. The method described in this chapter is based on measurement of this mass loss. The mass of biogas removed cannot be assumed to

equal the organic matter destroyed since hydrolytic water consumption increases and, conversely, CO_2 dissolution in solution decreases, the biogas mass. However, the quantity and composition of the biogas released from a bottle can be used to determine the methane produced, which is proportional to organic matter degradation and is the focus of the BMP assay. In this gravimetric method, mass loss and biogas composition are measured, and biogas and CH_4 production are determined from these. Determination of biogas quantity proceeds by estimating biogas density and the mass of water vapor present, which are used to determine dry biogas volume from mass loss. Methane production is then determined from composition and biogas volume. Composition affects biogas density, and so error in composition determination has a larger effect than in other methods. Conversely, the method is less sensitive to temperature and pressure errors than volumetric and manometric methods, and is not affected by biogas leakage.

Mass of a gas (or the mass change due to removal of a gas) can be measured in nearly the same way as for solids and liquids. Buoyancy can complicate measurements, but is irrelevant in this application, where the volume of a BMP bottle is virtually constant regardless of its internal pressure. Bottle mass can be determined with a high accuracy using an electronic laboratory scale. For example, a measurement of a 200 g bottle on a scale with an accuracy of 1 mg has six significant digits. This high level of relative precision does not translate directly into a similar precision in biogas or methane quantity measurements, since these are based on a relatively small difference in two large masses. Even so, an accuracy of 5 mL of CH_4 produced is achievable with this gravimetric method.

The gravimetric method described in this chapter is based on the method described by RICHARDS et al. (1991), which was later refined by HAFNER et al. (2015). For more details and evaluation, consult these two papers.

Devices and chemicals/aids

This gravimetric BMP method requires some of the same supplies and equipment that are typically used in manual volumetric and manometric methods, along with an electronic scale.

- electronic scale (see Section “Device Parameters”, below)
- glass or plastic serum bottles, 100 mL or larger, 3 per substrate and 9 or 10 additional bottles for triplicate blanks, cellulose controls and water controls.
- bottle septa (butyl recommended, other types acceptable)
- beveled needles (21 gauge recommended, smaller acceptable but venting will be slower)
- substrate
- microcrystalline cellulose (positive control substrate)
- inoculum from a stable anaerobic digester (RAPOSO et al. 2011; HOLLIGER et al. 2016 and Section 8.5 Engler and 10.3 Liu)

Device parameters

The electronic scale must have sufficient capacity and accuracy. Capacity must be greater than the mass of the heaviest bottle with inoculum and substrate. Required accuracy in weighing depends on the required accuracy in methane volume. Resolution in CH_4 volume is approximately 0.5 mL per mg of measured mass loss, so an accuracy of 0.1 g (100 mg) corresponds to approximately 50 mL of CH_4 . Accuracy is generally reported by the manufacturer, but in practice may be somewhat larger (less accurate). Accuracy is always larger than readability (the number of displayed digits). For example, we have found an accuracy < 0.2 g (< 100 mL CH_4) for a scale with a maximum readability of 0.01 g, and an accuracy ca. 10 mg (5 mL CH_4) for a scale with a readability of 0.1 mg. An accuracy of 100 mL would be sufficient for a bottle that produces a total of 3 L of CH_4 (100 mL is ca. 3% of the total CH_4 volume) but insufficient for a bottle that produces only 300 mL (in this case, an accuracy of 5 mL would be adequate).

Execution method

Preliminary steps

Quantities of substrate and inoculum are selected following an established protocol (ANGELIDAKI et al. 2009; HOLLIGER et al. 2016 and Section 8.5 Engler and 10.3 Liu). Substrates should be mixed and ready for representative sub-sampling.

Setup

General information

At setup, inoculum and substrate are added to bottles, and the headspace of each bottle is flushed to remove O_2 and ensure anaerobic conditions. For gravimetric measurements, pure N_2 is preferred for flushing over mixtures containing CO_2 . Use of N_2 results in a (generally small) error because its density may differ from produced biogas density (although the density of N_2 is identical to a CH_4/CO_2 mixture with 58% CH_4) but this can be corrected in calculations (see "Calculations" section below). Bottles are then weighed and placed in an incubator. Three (preferably four) bottles should be used for inoculum only, three for cellulose, three for each substrate, and two or three for water controls used to check the scale precision and accuracy.

Step-by-step instructions

1. Check the accuracy of the scale with a weight set. It is particularly important that the actual accuracy is close to required accuracy when weighing an object with a mass close to the total mass of a BMP bottle and its contents. For a scale with a reported accuracy of 50 mg, for example, this could be checked by taring the scale with a full bottle or equivalent mass, adding a 50 mg weight, removing it, and adding a 100 mg weight.

2. Add the required mass of inoculum, substrate, and other additions (such as a trace element solution) to each labeled bottle and seal with a septum and cover. For wet substrates determination of the quantity of material added by mass difference is the recommended approach: tare scale with bottle, add approximately the desired quantity, wipe any spilled material from near the mouth of the bottle, and finally determine the actual quantity from the scale reading. Note that the scale used here does not need to be the same scale used for determining mass loss (see “Incubation and sampling” section below).
3. Flush the bottle headspace (preferably with N_2) to remove O_2 . A simple approach is to use a needle attached to a flow meter (e.g. a rotameter), a pressure regulator (to ensure low pressure), and a gas cylinder (generally N_2) with plastic tubing, along with a separate needle for venting. Minimize CO_2 removal by flushing for only 3 to 4 headspace volume exchanges. Ensure that the flushing gas does not bubble through the liquid in the bottle (needle should not be submerged). Allow the pressure in each bottle’s headspace to equilibrate with atmospheric pressure before removing the venting needle.
4. Weigh each bottle and record as “initial mass”. Repeat this initial weighing in order to minimize the chance of a recording error, because calculations of cumulative CH_4 production at all timepoints require an accurate initial mass measurement. If there is a discrepancy between these two initial measurements, weigh again to determine the correct mass.
5. Place bottles in incubator set at the test temperature.

Incubation and sampling

General information

Bottles are removed from the incubator occasionally to vent, weigh, and take a biogas sample for analysis, in what is here referred to as a “sampling event”. Biogas temperature affects water vapor loss and consequently the relationship between mass loss and standardised biogas volume (although less so than in volumetric and manometric methods). As such, the time that bottles spend outside the incubator should be short, and the same procedure and timing should be followed for each sampling event. Ideally, venting and weighing should be done inside a temperature-controlled room, so bottles are always at the incubation temperature. However, the effects of headspace temperature on accuracy are small, so this is not required.

The accuracy of the gravimetric method is not affected by headspace pressure or leakage of biogas. However, for safety (to avoid exploding bottles) and to minimize possible effects of high CO_2 dissolution, total headspace pressure (absolute) should be kept below 3 bar. Bottle pressures can be estimated from headspace volume and calculated biogas production after measuring mass loss (see “Calculations” section below).

Step-by-step instructions

1. Remove all water control bottles from the incubator and weigh them to confirm scale consistency. If the results are the same as the initial masses (within the expected accuracy) proceed, otherwise, identify and address problem with the scale or replace the scale if necessary.
2. Remove a single set of replicates from the incubator (e.g. the three replicates for cellulose).
3. Always starting with the same replicate (e.g. “1” or “a”) gently swirl the bottle contents for at least 10 s to mix the reacting material and encourage CO₂ equilibration between solution and headspace. During swirling, avoid contact between the liquid and the septum.
4. Collect a biogas sample from the bottle using a syringe. Puncture the septum with a needle attached to a syringe, and allow the syringe to fill under pressure. Inject the required gas volume into a gas chromatograph for biogas composition analysis or into a gas sample container for later analysis.
5. Vent the bottle by puncturing the septum with a needle. Allow biogas to escape until headspace pressure has equilibrated with atmospheric pressure. This can be done by attaching a short length of plastic tubing to the venting needle, and briefly submerging it in a few mm of water during venting. Pressures are approximately equal once bubbling has ceased.
6. Weigh the bottle after venting, and record the mass and time. For the final weighing at the end of the experiment, weigh bottles twice and record both masses. In case of a discrepancy, weigh again to determine the correct final mass.
7. Proceed to the next replicate (e.g. “2” or “b”) and repeat steps 3–6.
8. After all replicates have been sampled, vented, and weighed, place the bottles back in the incubator.
9. Proceed to the next set of replicates (e.g. the three replicates for substrate “food waste A”) and repeat steps 2–8.

Additional considerations

The gravimetric method can easily be combined with volumetric or manometric measurements, in cases when users are interested in comparing methods or using multiple approaches for greater confidence in high-importance trials. Bottle headspace pressure can be measured between steps 3 and 4 and 5 and 6 in order to determine biogas production using a manometric approach. Or, a volumetric approach can be included by removing and measuring all excess headspace biogas in step 4 (e.g. with the help of a manometer).

Calculations

General information

The standardised volume of CH₄ produced and released by venting is calculated separately for each bottle and for each incubation interval, based on the observed mass loss and an estimate of biogas density and water vapour content. Biogas density is calculated from composition, assuming that biogas consists of only CH₄ and CO₂. When flushing gas density differs from biogas density, this assumption is not exactly accurate, but the resulting small error can be corrected (see supplementary material in HAFNER et al. (2015) and the software described below). Water vapour content is determined from an estimate of headspace pressure and temperature, assuming saturation with water vapour inside the bottle prior to venting. Details are given in the equations below, which can be entered into a spreadsheet template or a script. However, existing software tools provide access to these equations, including the biogas package (an add-on package for the R environment, <https://cran.r-project.org/package=biogas>) and OBA (for the Online Biogas App, which runs in a browser, <https://biotransformers.shinyapps.io/oba1/>) (HAFNER et al. 2018). These tools can also be used to correct for the flushing gas density error. Derivation and more details on all equations are given in HAFNER et al. (2015).

Equations

Steps for calculating biogas and CH₄ production from measured mass loss are:

1. Normalize measured CH₄ concentration:

$$x_{\text{CH}_4} = c_{\text{CH}_4} / (c_{\text{CH}_4} + c_{\text{CO}_2}) \quad 98$$

2. Calculate biogas molar mass (g mol⁻¹).

$$M_B = 16.04 x_{\text{CH}_4} + 44.01 (1 - x_{\text{CH}_4}) \quad 99$$

3. Calculate density of dry biogas (g L⁻¹) from biogas molar volume.

$$\rho_B = M_B / 22.3 \quad 100$$

4. Estimate water vapor partial pressure (kPa) with a Magnus form equation.

$$p_{\text{H}_2\text{O}} = 0.61094 \cdot \exp(17.625 \cdot T / (243.04 + T)) \quad 101$$

5. Determine the water concentration: water mass per unit dry biogas volume (g L⁻¹) removed per litre of dry biogas.

$$c_{\text{H}_2\text{O}} = 18.02 \cdot p_{\text{H}_2\text{O}} / (22.3 \cdot (p_B - p_{\text{H}_2\text{O}})) \quad 102$$

6. Calculate the standardised volume of biogas (L).

$$V_B = \Delta m / (\rho_B + c_{H_2O}) \quad 103$$

7. And finally, calculate CH₄ volume (L).

$$V_{CH_4} = x_{CH_4} \cdot V_B \quad 104$$

Sources and magnitude of error

As with all BMP methods, this gravimetric method includes both systematic and random sources of error, but with important differences as compared to volumetric and manometric methods. Unlike other methods, errors in sequential mass determinations are not independent in the gravimetric method but instead individual errors compensate for each other. The dependence and compensation are due to the use of two mass measurements (before and after a given incubation interval) to determine mass loss. To illustrate, consider a case where, for simplicity, biogas composition is constant during the incubation sequence. Total measured CH₄ production would depend only on the initial and final masses, and would be unaffected by errors in intermediate mass measurements. This is the reason that scale accuracy should be assessed relative to total CH₄ production, and not production individual intervals. Furthermore, a missing intermediate value (mass measurement) can generally be ignored without significantly affecting results. As long as the error or missing value is not present for the first or last weighing, it will have only a small effect on the estimate of total CH₄ production. This characteristic is a significant advantage over manometric or volumetric methods, where a single erroneous (or missing) measurement affects all subsequent results (including the final BMP value).

The resolution of the gravimetric method is similar to other methods, assuming accuracy in mass measurements can be kept to 10 mg or below. The most common volumetric methods have a resolution of 1 to 10 mL of CH₄, depending on the system used. Syringe-based volumetric methods probably have a resolution of 5–10 mL. Manometric methods based on a digital manometer with an accuracy of 1 kPa could, in theory, have a resolution of 1 mL or less. With a scale accuracy of 0.1 mg, production of as little as 0.05 mL of CH₄ could be measured by the gravimetric method in theory, but this resolution is not attainable in practice. In our experience, an electronic scale with a readability of 0.1 mg shows accuracy of 10 mg with water control bottles, corresponding to about 5 mL of CH₄. This conclusion is supported by a comparison between manometric and gravimetric results (HAFNER & ASTALS 2019).

Gravimetric estimates of CH₄ production are only slightly sensitive to errors in biogas temperature and pressure. Errors smaller than +/-5 °C and +/-50 kPa will result in errors in CH₄ volume smaller than 1.3% and 0.7%, respectively (HAFNER et al. 2015). Therefore, approximated estimates of biogas temperature and pressure are acceptable. Conversely, results are very sensitive to biogas composition. An error of 0.03 mol mol⁻¹ (e.g. use of $x_{CH_4} = 0.68$ when the true value is 0.65) causes an 8% error in determined CH₄ volume (HAFNER et al.

2015). Importantly, it is not possible to estimate even total biogas production without estimates of CH_4 and CO_2 content. An extension of this gravimetric method that does not require determination of biogas composition is under development (JUSTESEN et al. 2019). As mentioned above, if the density of the initial headspace (i.e. the flushing gas) is different from the average biogas density, this contributes an additional error. With N_2 as the flushing gas, a headspace volume of 300 mL, x_{CH_4} of 0.65 mol mol⁻¹, and total biogas production of 1 L, the error will be 2.7 % (HAFNER et al. 2015). Use of a flushing gas with a similar composition to biogas, a smaller headspace, and higher total biogas production will all reduce the magnitude of the error. If N_2 is used as a flushing gas, both software tools described above can be used to correct for this source of error based on the difference in gas densities.

Example calculations

This example calculation of the gravimetric method is based on data from a BMP trial using substrates in 1 L glass bottles. Mass and composition measurements for the first three incubation intervals (out of a total of nine) are given in Tab. 8.10. Scale accuracy was determined to be approximately 0.1 g, which was the same as its readability. Resulting mass loss measurements had only a single significant digit in most cases, but the final BMP estimate had a much better relative precision, due to compensation among errors (relative standard deviation in BMP values was under 4 % for all three substrates used in this trial).

Table 8.10: The first three measurements of bottle mass and biogas composition for gravimetric BMP determination of an animal feed substrate incubated in a 1 L bottle. Initial mass was 1058.7 g

Interval	Time (d)	Mass after venting (g)	Interval mass loss Δm (g)	CH_4 mole fraction x_{CH_4}
1	1.0	1057.7	1.0	0.668
2	2.3	1056.2	1.5	0.572
3	3.1	1055.5	0.7	0.531

During interval 1, 1.0 g of mass was lost during biogas venting. Analysis of a biogas sample gave a normalized CH_4 content of 0.668 (mole fraction).

From Eq. (99), biogas molar mass is:

$$M_B = 16.04 \cdot 0.668 + 44.01 (1 - 0.668) = 25.33 \text{ g mol}^{-1} \quad 105$$

Dry biogas density is estimated as:

$$\rho_B = 25.33/22.3 = 1.136 \text{ g L}^{-1} \quad 106$$

Water vapor partial pressure prior to venting depends on temperature:

$$p_{\text{H}_2\text{O}} = 0.61094 \cdot \exp\left(17.625 \cdot \frac{30}{243.04 + 30}\right) = 4.237 \text{ kPa} \quad 107$$

The concentration of water in removed biogas depends on headspace pressure (absolute), which was assumed to be 200 kPa here.

$$c_{\text{H}_2\text{O}} = 18.02 \cdot 4.237 / (22.3(200 - 4.237)) = 0.0175 \text{ g L}^{-1}$$

108

Standardised volume of biogas (STP) is:

$$V_B = \frac{1.0}{1.136 + 0.0175} = 0.867 \text{ L}$$

109

And finally, CH_4 volume is:

$$V_{\text{CH}_4} = 0.668 \cdot 0.867 = 0.579 \text{ L} = 579 \text{ mL}$$

110

Methane production can be calculated similarly for intervals 2 and 3, and the resulting cumulative CH_4 production for the three intervals is 1538 mL. (Readers can check their calculations by comparing the sum of the values they calculate with this.) If corrections due to the difference between N_2 and biogas density and to a lower initial headspace temperature (around 20 °C in this case) are applied using the biogas package function `mass2vol()`, this total methane production is reduced to 1,454 mL. This difference of 85 mL is relatively small compared to total production over 31 d, which was 2,395 mL (a difference of about 3.5%). For the best accuracy, these corrections should be applied using either OBA or the biogas package (see section "General information" above). All the calculations shown in this section can be done with either of these software tools.

8.11 Kinetic modelling of anaerobic batch tests

Sören Weinrich, DBFZ; Sergi Astals, University of Queensland; Sasha D. Hafner, Aarhus University; Konrad Koch, Technical University of Munich

The maximum biogas or methane potential as well as the rate of gas production are key parameters for comprehensive substrate characterisation and efficiency evaluation of anaerobic digestion plants. Both parameters are crucial quality criteria for monetary rating of different substrate types and enable reliable process balancing and design of biogas plants. In consideration of a specific organic loading rate and respective retention time, both parameters can be applied for a realistic approximation of the resulting gas yield during continuous plant operation.

Generally, the study of reaction rates as well as individual parameters which characterise the temporal progression of gas produced over time are referred to as kinetics. The biogas potential of a specific substrate defines the maximum amount of biogas that can be produced during anaerobic digestion (WEINRICH et al. 2018). During discontinuous (batch) anaerobic digestion a change in the biogas or methane potential will raise or lower the progression of cumulative gas production (Fig. 8.11-1a). A change in degradation kinetics will accelerate or slow down anaerobic digestion (Fig. 8.11-1b).

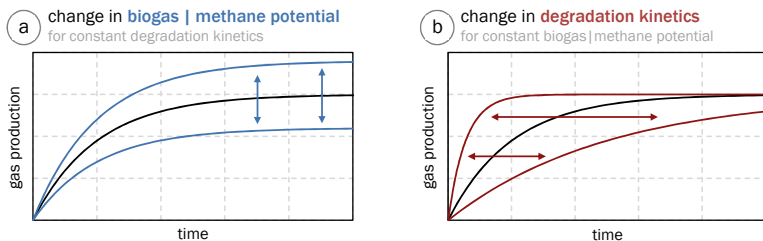

Figure 8.11-1: Effects of changes in biogas or methane potential and degradation kinetics on cumulative gas production during discontinuous (batch) operation (Source: WEINRICH et al. 2018)

A practical methodology for direct and precise determination of the biogas potential and degradation kinetics is still missing, since fundamental parameters such as microbial growth, yield or activity as well as the detailed stoichiometric composition, anaerobic degradability or individual degradation pathways of the utilised substrates are most often unknown. Numerous estimation procedures based on stoichiometric calculations, mass or energy balancing, biochemical analysis or laboratory experiments are available for substrate and process characterisation (LESTEUR et al. 2010). Anaerobic batch tests (also known as biochemical methane potential or biomethane potential tests) are the most common approach to estimate biogas or methane potentials and quantify degradation kinetics in an experimental laboratory test setup (HAFNER et al. 2020, HOLLIGER et al. 2016).

The measured biogas or methane yield (final experimental value) during batch operation is generally considered equivalent to the ultimate biogas or methane potential of the tested substrate. However, due to comparably short test duration (test time usually ≤ 30 days) and numerous influencing factors (RAPOSO et al. 2011, HOLLIGER et al. 2016, WEINRICH et al. 2018) slowly degradable, particulate or lignocellulosic substrates are not entirely degraded at test termination. Diverse opinions about individual termination criteria as well as the general validity of batch tests to determine the maximum biogas or methane potential are being discussed today (HAFNER et al. 2020, HOLLIGER et al. 2017, WEINRICH et al. 2018).

Kinetic models can be utilised to assess temporal progression of gas production. Suitable mathematical functions based on first-order reaction kinetics or empirical expressions are commonly applied to characterise degradation kinetics of anaerobic batch tests. During model application unknown parameters are estimated to enable calculation (simulation) of measured gas production. Thereby, individual model parameters reflect characteristic process behaviour and enable a clear interpretation of degradation kinetics. Kinetic parameters – such as first-order reaction constants – can serve as a reliable basis for kinetic evaluation of various substrate types and pre-treatments. However, the validity of batch tests to describe effective degradation kinetics (and underlying gas potential) of continuous operated anaerobic digestion processes is rarely investigated or proven in detail (BATSTONE et al. 2009, JENSEN et al. 2011, WEINRICH & PRÖTER 2017). Changes in experimental conditions, such as the inoculum-to-substrate ratio (ISR), can result in changes in reaction kinetics, which implies that parameters estimated from batch tests do not reflect intrinsic properties of the tested substrate (WARD et al. 2018, KOCH et al. 2019).

Beside the choice of a suitable model structure and the estimation of optimal parameter values, accurate data processing according to available guidelines (VDI 4630 2016, ANGELIDAKI et al. 2009 or HOLLIGER et al. 2016) lays the foundation for a comprehensive model-based evaluation of anaerobic batch tests. Typically, this includes normalisation of biogas production to standard temperature and pressure as well as corrections for water vapour to indicate dry biogas. The resulting gas production is usually expressed as a volume of biogas or methane in L per kg volatile solids (VS) or chemical oxygen demand (COD) of substrate added. Furthermore, additional information should be included in the final report to increase transparency, validity and enable comparability of different trials or methods (ANGELIDAKI et al. 2009):

- origin, sampling, storage, pre-treatment and physio-chemical parameters of the tested substrate and utilised inoculum,
- test conditions, experimental setup and procedures (including measuring techniques),
- individual results of total biogas production of substrate, blanks and positive control,
- statistical evaluation of replicates (relative average and standard deviation).

Model structures

Scientific literature offers numerous kinetic functions to enable a detailed description of microbial growth, maintenance or decay as well as associated substrate degradation and product formation (PAVLOSTATHIS & GIRALDO-GOMEZ 1991, BASTIN & DOCHAIN 1991, KYTHREOTOU et al. 2014). Based on individual kinetic rate equations and various stoichiometric degradation pathways (including phase-transition and physico-chemical dependencies), numerous process models have been developed for simulation of anaerobic digestion (LYBERATOS & SKIADAS 1999, GAVALA et al. 2003, BATSTONE et al. 2015). Comprehensive model structures, such as the established Anaerobic Digestion Model No. 1 (BATSTONE et al. 2002) or the model developed by BERNARD et al. (2001) have been applied to describe discontinuous degradation in anaerobic batch tests (BIERNACKI et al. 2013, DONOSO-BRAVO et al. 2013). However, due to the characteristic progression and limited number of available measurements a direct and unique parameterisation of respective model structures – including microbial growth rates of involved species of non-rate-limiting process phases – to describe discontinuous digestion is hardly possible. On the contrary, the knowledge of rate-limiting process steps enables simplified process description, which most often results in the same accuracy during simulation of batch tests in comparison to complex model structures. Thus, a small share of simple model approaches (mathematical functions) based on

- first-order reaction kinetics,
- MONOD-type kinetics or the
- modified GOMPertz function

have proven their applicability for model-based evaluation of batch test in practice. Depending on the individual substrate composition and resulting degradation behaviour, each model has specific advantages or drawbacks. The objective and area of application influence the choice and implementation of the applied model structures as well as suitable methods for parameter estimation and evaluation procedures, as discussed in the following sections.

First-order reaction kinetics

During anaerobic degradation of particulate materials, hydrolysis often limits the overall reaction rate, whereas methanogenesis is commonly rate-limiting for easily accessible and dissolved substrates. Since the early days of anaerobic process modelling, hydrolysis functions based on first-order reaction kinetics have been applied as “an empirical expression that reflects the cumulative effect of all the microscopic processes occurring in the digester” (EASTMAN & FERGUSON 1981:61–362). There are numerous factors that affect the rate at which materials are hydrolysed (SANDERS 2001). Chemical composition and physical structure influence degradation kinetics. Therefore, carbohydrates, such as cellulose or starches, are hydrolysed at different rates and physical configuration in comparison to enzymatic degradation of lipids or proteins. Large particles with a low surface-to-volume ratio are degraded more slowly than small particles (SANDERS et al. 2000 or ESPOSITO et al. 2008). High inoculum-to-substrate ratios are used to prevent nutrient limitation or process inhibition during anaerobic batch tests. Thereby, degradation and product formation depends

solely on the concentration of the rate-limiting substrate (neglecting microbial growth). Consequently, substrate dependent first-order reaction kinetics can be applied to describe overall process behaviour and respective gas production during discontinuous anaerobic digestion as well.

For batch test modelling, single first-order kinetics (one-step one-fraction) in Eq. 111 are most commonly used and suggested in available guidelines of ANGELIDAKI et al. (2009) or VDI 4630 (2016). Hence, the cumulative biogas or methane production at a specific point in time $S(t)$ can be calculated based on the maximum methane potential S_{\max} and the respective first-order degradation constant k .

One-step one-fraction first-order kinetics

$$S(t) = S_{\max} \cdot (1 - e^{-k \cdot t}) \quad 111$$

Two-steps one-fraction first-order kinetics

$$S(t) = S_{\max} \cdot \left(1 + \frac{k \cdot e^{-k_{VFA} \cdot t} - k_{VFA} \cdot e^{-k \cdot t}}{k_{VFA} - k} \right) \quad 112$$

One-step two-fraction first-order kinetics

$$S(t) = S_{\max} \cdot (1 - \alpha \cdot e^{-k_1 \cdot t} - (1 - \alpha) \cdot e^{-k_2 \cdot t}) \quad 113$$

Two-steps one-fraction first-order kinetics

114

$$S(t) = S_{\max} \cdot \left[\alpha \cdot \left(1 + \frac{k_1 \cdot e^{-k_{VFA} \cdot t} - k_{VFA} \cdot e^{-k_1 \cdot t}}{k_{VFA} - k_1} \right) + (1 - \alpha) \cdot \left(1 + \frac{k_2 \cdot e^{-k_{VFA} \cdot t} - k_{VFA} \cdot e^{-k_2 \cdot t}}{k_{VFA} - k_2} \right) \right]$$

$S(t)$	Time-dependent cumulative biogas methane yield	L kg ⁻¹ VS
S_{\max}	Biogas methane potential	L kg ⁻¹ VS
k_1	First-order degradation constant of substrate fraction 1	d ⁻¹
k_2	First-order degradation constant of substrate fraction 2	d ⁻¹
k_{VFA}	First-order degradation constant of volatile fatty acids (VFA)	d ⁻¹
α	Ratio of substrate fraction 1 to total degradable substrate	[-]
t	Time	d

As illustrated in Fig. 8.11-2, BRULÉ et al. (2014) introduced a collection of valuable extensions based on the superposition of first-order kinetics. A two-step one-fraction model (Eq. 112) describes formation and degradation of an additional intermediate such as the sum of volatile fatty acids (VFA), whereas a division of the maximum methane or biogas potential in a one-step two-fraction model (Eq. 113) enables the utilisation of two different reaction constants e.g. by distinguishing between slowly and rapidly degradable substrate components. The two-step two-fraction model (Eq. 114) results from the consistent combination of both model extensions (Eq. 112 and 113). Thus, individual models include additional parameters to characterise degradation kinetics of different substrate components (k_1 and k_2) or intermediates (k_{VFA}).

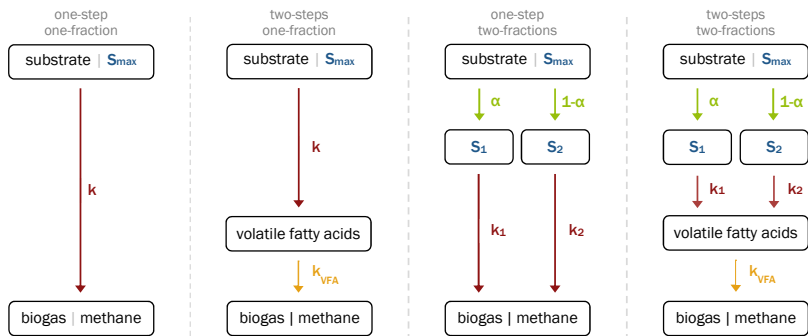

Figure 8.11-2: Simplified model structures based on superposition of first-order reactions kinetics (adapted from BRULÉ et al. 2014)

By adjusting individual model parameters, the derived functions offer various degrees of freedom to enable a close depiction of gas production. However, due to the limited number of available measurements (biogas and/or methane production over time), a reasonable mechanistic interpretation of characteristic model parameters cannot be guaranteed in general.

To account for a lag phase at the beginning of an experiment, delayed first-order kinetics according to ASTALS et al. (2015) can be applied (Eq. 115). Based on single first-order kinetics (one-step one-fraction) an additional lag phase parameter λ moves the starting point for process modelling to later days. However, a detailed depiction of the decelerated start-up phase before the initial time ($t > \lambda$) is not possible (as shown in Fig. 8.11-6). Delayed first-order kinetics (one-step one-fraction)

$$S(t) = S_{\max} \cdot (1 - e^{-k \cdot (t-\lambda)})$$

115

$S(t)$	Time-dependent cumulative biogas methane yield	L kg ⁻¹ VS
S_{\max}	Biogas methane potential	L kg ⁻¹ VS
k	First-order degradation constant	d ⁻¹
λ	Lag time	d
t	Time	d

MONOD-type kinetics

Utilising basic functional dependencies to describe steady-state conditions during continuous anaerobic digestion (EASTMAN & FERGUSON 1981), an alternative approach based on MONOD-type kinetics has been developed by KOCH & DREWES (2014), Eq. 116. In compliance to single first-order kinetics (one-step one-fraction in Eq. 111), the maximum biogas or methane potential S_{\max} as well as a degradation constant k to describe temporal progression of gas production $S(t)$ have to be adjusted during parameter estimation. Due to the specific functional behaviour, MONOD-type kinetics can explicitly be deployed for simulation of slowly degradable materials (KOCH & DREWES 2014).

MONOD-type kinetics

$$S(t) = S_{\max} \cdot \left(\frac{k \cdot t}{1 + k \cdot t} \right)$$

116

$S(t)$	Time-dependent cumulative biogas methane yield	L kg ⁻¹ VS
S_{\max}	Biogas methane potential	L kg ⁻¹ VS
k	Degradation constant	d ⁻¹
t	Time	d

Modified GOMPertz function

Besides different model structures based on first-order or MONOD-type kinetics, the modified GOMPertz function in Eq. 117 is also applied for process simulation of anaerobic batch tests. The GOMPertz equation was originally developed to describe bacterial growth by a typical sigmoidal function (GOMPertz 1825, ZWIETERING et al. 1990). For its transformation to depict discontinuous anaerobic degradation, individual model parameters such as S_{\max} or λ have to be adjusted to describe the maximum gas potential or an initial lag phase at the beginning of the experiment, respectively.

Modified GOMPertz equation

$$S(t) = S_{\max} \cdot e^{-e^{\left(\frac{R_m \cdot e}{S_{\max}} (\lambda - t) + 1\right)}} \quad 117$$

$S(t)$	Time-dependent cumulative biogas methane yield	L kg ⁻¹ VS
S_{\max}	Biogas methane potential	L kg ⁻¹ VS
R_m	Maximum biogas methane production rate	L kg ⁻¹ VS d ⁻¹
λ	Lag time	d
t	Time	d

Generally, any mathematical expression that evinces exponential or sigmoidal functional behaviour can be applied to depict discontinuous gas production of an anaerobic batch test. Thus, further approaches based on logistic functions, transference functions or exponential expressions (DONOSO-BRAVO et al. 2010, STRÖMBERG et al. 2015) can also be applied to describe experimental process behaviour. Since individual parameters of universal mathematical functions allow no clear biochemical interpretation and most often do not reflect valuable properties for substrate characterisation, the benefit of their application is rather limited. Mathematical expressions, such as the modified GOMPertz function, can be utilised for reliable extrapolation of the maximum gas potential or precise characterisation of lag phase behaviour (e.g. during anaerobic degradation of microcrystalline cellulose in Fig. 8.11-6).

However, following available guidelines (VDI 4630 2016, ANGELIDAKI et al. 2009 or HOLLIGER et al. 2016) discontinuous digestion of most substrates should not show a pronounced delay in gas production during the beginning of an experiment, as long as crucial factors are considered properly. Thus, a strong lag phase most often indicates faults in the experimental setup or test conduction (KOCH et al. 2019). In this case, model application for a detailed description of lag phase behaviour needs to be questioned and reconsidered, depending on the overall aim for model-based evaluation of respective batch test measurements.

Model implementation

Based on the presented equations, individual model structures can be implemented directly into spreadsheet calculation software such as Microsoft Excel or Open Office Calc and solved for respective time steps. Furthermore, commercial scientific programming tools, like Matlab or free software environments such as Octave, Scilab or R, can assist during calculation and evaluation of simulation results. These programs include powerful optimisation algorithms which can be applied for numerical parameter estimation to provide an optimal set of model parameters which ensure the best possible depiction of respective measurements (depending on the chosen model structure). Additionally, respective programs include useful tools for data processing, statistic evaluation and graphical illustration.

Parameter estimation

For model-based evaluation of experimental batch tests, unknown parameter values of the derived model structures have to be adjusted to gain realistic simulation results. Numerous estimation procedures are available to enable precise depiction of individual process conditions and measurements (WALTER & PRONZATO 1997, DOCHAIN & VANROLLEGHEM 2001, ISERMANN & MÜNCHOFF 2011). However, the underlying methodical approach and functional components for basic parameter estimation are similar for many established procedures (Fig. 8.11-3).

During initialisation, the chosen model structure is evaluated for a set of initial parameter values. The respective simulation results are then compared to experimental measurements. For every time step t , the deviation $e(t)$ between measurements $y(t)$ and simulation results $\hat{y}(t)$ is calculated and summarised by a suitable objective function in a single value J_{opt} . Based on a defined quality criterion, the loop is iteratively repeated (best fit = no) for small changes in parameter values $\Delta\theta$ or terminated (best fit = yes), if the requested error tolerances or convergence criteria have been met. Parameter adjustment $\Delta\theta$ of unknown parameter values can either be fitted manually or identified based on numerical optimisation procedures.

Besides the definition of initial values and reasonable constraints for variable model parameters, basic data processing and data transformation as well as the choice of a suitable objective function and optimisation procedure will affect the outcome of the respective estimation task.

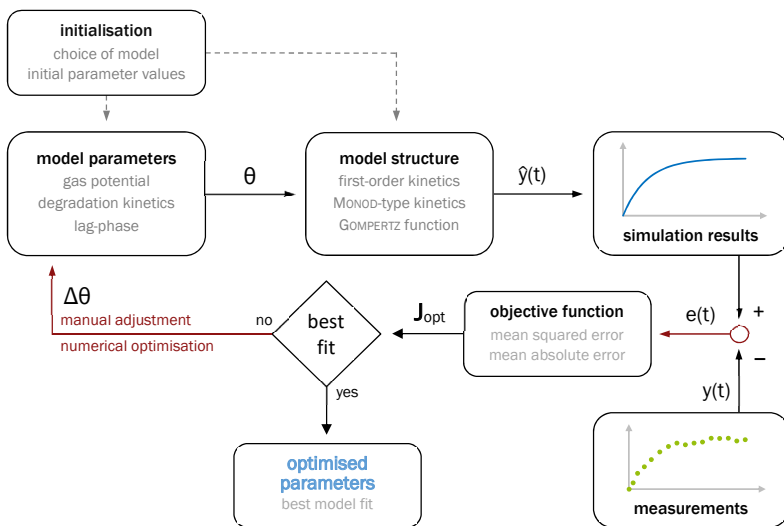

Figure 8.11-3: Flow chart of the fundamental procedure for estimating unknown model parameter values

Data processing and transformation

Data preparation should be conducted carefully according to the available standards and scientific practise. Standardised software tools are now available for processing batch test measurements to calculate methane yields and validate inhouse data processing (HAFNER et al. 2018). Furthermore, data transformation can improve estimation or enable graphical determination of individual model parameters.

The model structures presented above are empirical simplifications of the complex anaerobic digestion process and therefore cannot describe irregular process behaviour (including microbial community dynamics/changes or the effect of inhibitory substances and intermediates) in detail. Experimental values that deviate strongly from the typical exponential gas progression will often lead to poor simulation results and invalid model parameters (Koch et al. 2019). Data sets including single extreme values caused by technical malfunctions or biochemical process disturbance can also hamper parameter estimation. Thus, evidently incorrect measurements should be excluded prior to parameter estimation. Furthermore, negative gas production (rates) originating from cases where the gas production from blanks is higher than the gross gas production of the sample, should be eliminated from the data set as well. The presence of many observations that need to be excluded is a sufficient reason for identifying and addressing problems within the utilised experimental setup, and repeating an experiment.

Specific cumulative biogas or methane production is typically used for description and evaluation of anaerobic batch tests (Fig. 8.11-4a). However, in this case individual measurements are not independent of each other since a single value $S(t=k)$ depends on previous $S(t<k)$ observations. Thus, measurement errors will be propagated into model-based evaluation and estimated parameter values or uncertainty estimates may be biased. To avoid this problem, average gas production rates ($\Delta S/\Delta t$) should be applied for parameter estimation (Fig. 8.11-4b). In this case, simulation results consequently also have to be transformed in the same manner to ensure correct calculation of the objective value.

Transformation of single first-order kinetics based on normalised logarithmic gas production evinces a linear progression of experimental measurements and simulation results (Eq. 119 and Fig. 8.11-4c). In theory the absolute slope of the resulting linear function characterises the first-order reaction constant k . However, measurements close to the final gas potential ($S(t) \approx S_{\max}$) at the end of the experiment will lead to small residuals. During logarithmic transformation small residuals will consequently result in larger numbers and therefore have a stronger influence on the representing first-order constant (compared to observations at the beginning of the experiment). Furthermore, the maximum biogas or methane potential S_{\max} has to be defined before data transformation (e.g. based on the final experimental value) or iteratively adjusted to yield optimal process depiction. Thus, estimation of first-order kinetics based on non-linear regression is advised (in comparison to logarithmic transformation).

Basic linear function

$$y(x) = a \cdot x + b$$

118

Linearisation of first-order kinetics

$$\ln\left(\frac{S_{\max}-S(t)}{S_{\max}}\right) = -k \cdot t \quad y = \ln\left(\frac{S_{\max}-S(t)}{S_{\max}}\right) \quad | \quad x = t \quad | \quad a = -k \quad | \quad b = 0$$

119

Linearisation of MONOD-type kinetics

$$\frac{1}{t} = S_{\max} \cdot k \cdot \frac{1}{S(t)} - k \quad y = \frac{1}{t} \quad | \quad x = \frac{1}{S(t)} \quad | \quad a = S_{\max} \cdot k \quad | \quad b = -k$$

120

y	Dependent variable	<i>not specified</i>
x	Independent variable	<i>not specified</i>
a	Slope of the line	<i>not specified</i>
b	Intercept with ordinate axis (shift or displacement constant)	<i>not specified</i>
S(t)	Time-dependent cumulative biogas methane yield	L kg ⁻¹ VS
S _{max}	Biogas methane potential	L kg ⁻¹ VS
k	Degradation constant (first-order or MONOD-type)	d ⁻¹
t	Time	d

During linearisation of MONOD-type kinetics abscissa and ordinate (x and y axis) are described by the inverse biogas production and experimental time respectively (Eq. 120 and Fig. 8.11-4d). Therefore, the kinetic constant is characterised by the negative intercept with the ordinate, whereas the maximum biogas or methane potential can be retrieved by dividing the resulting slope by the respective kinetic constant (KOCH & DREWES 2014).

Depending on the specific model structure, further kinetic approaches can be linearised for graphical representation of individual model parameters. Thus, linearisation can be used for initial parameter estimate selection and visual assessment of appropriateness of model structures.

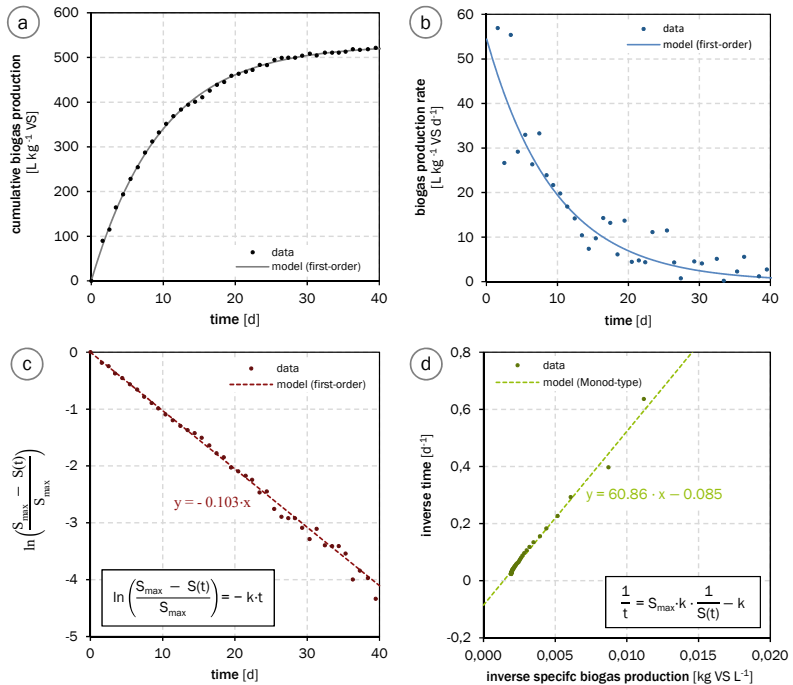

Figure 8.11-4: Different examples of data transformation for parameter estimation during discontinuous anaerobic digestion of straw: (a) cumulative specific biogas production, (b) specific biogas production rate, (c) linearisation of first-order kinetics and (d) linearisation of Monod-type kinetics

Parameter selection and constraints

Generally, the most influencing model parameters are identified based on local or global sensitivity analysis (TURANYI 1990, SALTELLI et al. 2005) and consequently selected for effective model adjustment (parameter estimation). However, deterministic and unique estimation of sensitive model parameters is rarely proven (NIHTILÄ & VIRKKUNEN 1977, HOLMBERG 1982, DOCHAIN et al. 1995). Thus, structural and practical identifiability of individual model parameters should be examined for the utilised model structure as well as for the number and precision of available measurements (WALTER & PRONZATO 1997, DOCHAIN & VANROLLEGHEM 2001).

Due to the simplified model structures and the restricted functional behaviour, most often all variable model parameters are adjusted during parameter estimation of batch test modelling. For comparison of different substrate types or pre-treatments individual parameters of more complex model structures can be fixed to show clear dependencies between the remaining variables (as shown in Tab. 8.11-2 and Example 8.11-3). Furthermore, if

additional calculation procedures provide a reliable and precise determination of individual parameter values – such as the stoichiometric approximation of biogas or methane potentials – these parameters can also be excluded from parameter estimation.

Since individual model parameters represent biochemical properties of anaerobic degradation, fundamental constraints should be respected during parameterisation. Whether specific boundaries for individual model parameters can be observed directly during parameter estimation (constraint optimisation) or have to be verified after termination of the utilised estimation procedure, depends on the chosen optimisation algorithm. Reasonable constraints for common parameter types are summarised below:

- specific biogas or methane potential: $S > 0$
- kinetic constants: $k > 0$
- fractioning parameters: $0 \leq \alpha \leq 1$
- lag-time: $\lambda \geq 0$

Specific biogas or methane yields as well as kinetic constants are obliged to be real numbers greater than zero; fractioning parameters should only be varied between zero and one. Parameters describing lag phase behaviour have to be equal or greater than zero. Any parameter value outside these ranges – even though they may yield to satisfying simulation results – are physically impossible and should be discarded. Initial values for parameter estimation should only be sampled from the remaining value range inside the previously defined constraints. Mathematical coefficients of black box or regression models offer no clear biochemical interpretation and therefore cannot be restricted (besides their functional limits).

Some model structures include single discontinuities (division by zero) for specific parameter combinations, which should be avoided during definition of initial values or manual adjustment. Thus, any model structure based on two-step first-order reaction kinetics cannot be solved for identical reaction constants of the first and second step ($k \neq k_{VFA}$ in Eq. 112 or $k_1 \neq k_{VFA}$ and $k_2 \neq k_{VFA}$ in Eq. 114).

Objective Function

Estimation procedures for determination of variable model parameters primarily depend on a suitable objective function and respective optimisation algorithm. For substantial assessment and effective minimisation of the residual model deviation, different objective functions and quality criteria can be applied, Eqs. 121–123.

Mean absolute error (MAE)

$$\frac{1}{n} \cdot \sum_{i=1}^n |y_i - \hat{y}_i|$$

Mean squared error (MSE)

$$\frac{1}{n} \cdot \sum_{i=1}^n (y_i - \hat{y}_i)^2 \quad 122$$

Mean logarithmic squared error (MLSE)

$$\frac{1}{n} \cdot \sum_{i=1}^n (\ln(y_i) - \ln(\hat{y}_i))^2 \quad 123$$

y	Individual measurements	L kg ⁻¹ VS
\bar{y}	Mean value of all measurements	L kg ⁻¹ VS
n	Number of measurements	[-]
\hat{y}	Model output simulation results	L kg ⁻¹ VS

During process modelling of anaerobic digestion (mean) squared deviations between measurements and simulation results are most often utilised for calculating the objective value within the respective estimation procedure (DONOSO-BRAVO et al. 2011, WEINRICH 2017). To reduce the strong influence of extreme values on summation, the mean squared error (MSE in Eq. 121 and 122) can also be replaced by absolute differences (MAE in Eq. 121) or by logarithmic squared error (MLSE in Eq. 123). Furthermore, weighting factors for individual measurements can be applied to account for time-dependent measuring errors.

Optimisation procedure

In consideration of a suitable objective function, the variable model parameters have to be adjusted iteratively based on a suitable optimisation algorithm (according to Fig. 8.11-3). For simplified model structures containing only a few variable model parameters, systematic manual adjustment will most often result in reasonable simulation results. Monte-Carlos simulation that cover the complete value range of independent parameters can also be applied for determination of an optimal set of parameter values. However, with an increasing number of variable parameters both procedures can be very time consuming and cumbersome.

Thus, numerous procedures are available for numerical parameters adjustment (NOCEDAL & WRIGHT 2006). Common optimisation procedures are designed to identify a local optimum near initial values, whereas global optimisation procedures, e.g. based on evolutionary algorithms (GOLDBERG 1989, KRAMER 2017), guarantee the overall optimum inside the entire value range of the utilised objective function. During simulation of anaerobic degradation processes, classical local optimisation procedures such as the LEVENBERG-MARQUARDT algorithm or derivate free simplex methods are most often applied for parameter estimation (Tab. 3.8 in WEINRICH 2017).

To ensure best possible model adjustment and enable semi-global evaluation of the specific objective function, numerical estimation can be repeated for varying initial values (*multi-start strategy*) of respective model parameters (GYÖRGY & KOCSIS 2011). Thus, different initial values are sampled from the reasonable value range of individual parameters and evaluated by means of a local estimation procedure. Additionally, an optimised parameter set can be used as initial values for a consecutive estimation run, to guarantee convergence nearby the target value (DONSO-BRAVO et al. 2013). Finally, the semi-global optimum over all initial values can be selected.

The calculation of the FISHER Information Matrix (FIM) or the utilisation of an F-distribution in the objective function variation allow the definition of confidence intervals (e.g. 95 % confident regions as shown in BATSTONE et al. 2003) for estimated parameters (DOCHAIN & VANROLLEGHEM 2001).

Model evaluation

Various quality criteria for assessment of simulation results have been developed (JANSSEN & HEUBERGER 1996, KRAUSE et al. 2005, MORIASI et al. 2007). The choice of a respective indicator depends on the applied objective function used for parameter estimation. Thus, the coefficient of determination R^2 or comparable statistics based on squared differences should only be applied if an objective function based on squared errors (Eq. 122) is utilised during parameter estimation. Absolute errors (Eq. 121) therefore require a quality criteria based on absolute differences. Otherwise, the applied criteria will not reflect the specific behaviour of the objective function and underestimate the best possible model adjustment during parameter optimisation.

Further validation and interpretation of the utilised data basis or estimated gas potential and degradation kinetics will be discussed in the following sections.

Evaluation of biogas | methane potential

Based on the model structures presented in this chapter, the estimated parameter S_{\max} can be applied for a realistic approximation of maximum biogas or methane potential. However, if the final experimental value is significantly higher than the estimated gas potential of the kinetic model (e.g. during application of single first-order kinetics in Fig. 8.11-5), the last measurement should be used as the reported value for the respective gas potential of the investigated substrate.

Furthermore, numerous calculation procedures or reference values based on

- volatile solids or fermentable volatile solid,
- chemical oxygen demand,
- nutrien (macromolecules),
- regression models,
- elemental composition analysis,
- total (organic) carbon or
- calorific value,

can be utilised for an additional approximation and independent evaluation of the maximum gas potential of the investigated substrate to improve understanding and validity of individual batch test results (WEINRICH et al. 2018).

Evaluation of degradation kinetics

Estimated kinetic constants should be within reasonable and physically possible value ranges. Therefore, first-order rate constants must be greater than zero ($k > 0$), although they may vary by orders of magnitude. Values greater than 10 d^{-1} can be neglected during kinetic evaluation since turnover of the respective substrate or intermediate occurs almost instantaneously and is not process limiting. Due to the exponential behaviour of first-order kinetics, logarithmic transformation should be applied when comparing or illustrating individual kinetic constants of various trials or substrates. Furthermore, uncertainty intervals of estimated parameters should be included in the evaluation of degradation kinetics. WEINRICH (2017) compiled a comprehensive collection of first-order reaction constants (Appendix E). Due to the limited use of alternative model approaches, individual model parameters for extended first-order (Eqs. 112 to 115) or MONOD-type kinetics (Eq. 116) are seldom available.

Different model structures developed by BRULÉ et al. (2014) include up to five unknown parameters (two-step two-fraction model in Eq. 114) which have to be identified during parameter estimation. Depending on the respective measurements kinetic constants, describing specific degradation rates of individual substrate components sometimes result in the same value ($k_1 = k_2$). In this case, a clear separation of two substrate fractions is not necessary and does not improve the model fit. Thus, single-fraction first-order kinetics ($k = k_1 = k_2$) of the respective degradation step will yield identical simulation results.

In compliance with established gas potentials of fermentable nutrients (Tab. 9.4-1), reasonable value ranges for characteristics first-order degradation constants of carbohydrates, proteins or lipids can be defined (Tab. 8.11-1). Depending on the macromolecules composition of the utilised substrate, the reported ranges may be used for a rough verification of estimated kinetic parameters during model-based evaluation of batch tests. However, degradation kinetics do not depend on chemical composition alone and are also influenced by particle size and microscopic structure among others.

Table 8.11-1: Typical value ranges for first-order hydrolysis kinetics of characteristic nutrients

	First-order hydrolysis constant [d^{-1}]		
	Carbohydrates	Proteins	Lipids
PAVLOSTATHIS & GIRALDO-GOMEZ 1991	0.02 – 2.88	0.04 – 1.3	–
MATA-ÁLVAREZ 2003	0.5 – 2	0.25 – 0.8	0.1 – 0.7
WEINRICH 2017 ^{a)}	0.02 – 2.88	0.01 – 2.69	0.01 – 0.76

a) Based on $n = 32, 35$ and 9 samples for carbohydrates, proteins and lipids, respectively

Based on different aspects of model-based evaluation of anaerobic batch tests, three typical scenarios for application and interpretation of different kinetic models are described below.

Examples

Model implementation as well as numeric parameter identification for the following examples was performed in the software environment Matlab (Mathworks, USA). The trust-region-reflective algorithm (`lsqcurvefit`) was applied to minimise squared residuals of cumulative gas production of experimental and simulated values. Parameter specific boundaries (as reported in section "Parameter estimation", Parameter selection and constraints) were utilised to guarantee plausible parameter values.

Example 1: Estimating biogas | methane potentials

Complex organic materials, such as energy crops and agricultural wastes, typically include a wide range of structural components (e.g. cellulose, hemicellulose or lignin), which form different parts of plant cell walls. Anaerobic degradability regarding the maximum biogas or methane potential as well as degradation kinetics of respective substrates, such as maize silage, are typically examined based on laboratory batch tests (Fig. 8.11-5). Depending on the utilised termination criteria, gas production at the end of a trial occasionally still shows minor positive progression, which is caused by a small share of slowly degradable substrate components. Single first-order kinetics are most often not suitable to describe this specific process behaviour and typically provide a lower biogas or methane potential than the final experimental value. More sophisticated models based on two substrate fractions can depict the measured gas production in more detail (Fig. 8.11-5).

In this case, the estimated biogas potential typically shows higher values than the respective measuring results, which indicates that the underlying biogas potential is slightly higher than the final value of the experimental batch experiment. Providing a good fit of the respective simulation and experimental results, the estimated biogas yield is a reasonable approximation of the maximum biogas potential (at infinite digestion time). Furthermore, additional information about the utilised substrates can be gained (e.g. share of rapidly or slowly degradable substrate components) by application of extended model structures. However, even for precise simulation results, parameter estimation does not guarantee reliable and realistic parameter values in general. In which case extrapolation can be used for a reasonable approximation of the biogas or methane potential, still depends upon personal interpretation and experience. Therefore, the identified parameters – such as the maximum biogas potential or the individual kinetic constants – should thoroughly be reviewed to provide a meaningful set of parameters inside a reasonable value range.

Example 2: Modelling lag phase behaviour

During anaerobic digestion of fibrous particulate materials, such as lignocellulosic biomass, disintegration and hydrolysis most often define the rate limiting process steps (EASTMAN & FERGUSON 1981). Complex polymers have to be split into their monomeric elements to enable microbial uptake and degradation. Depending on the respective molecular composition, the cleavage of structure-reinforcing bonds (catalysed by the extracellular enzymes) can delay successive process phases, such as acidification and methane formation, significantly.

Microcrystalline cellulose, that serves as a reference standard to evaluate batch test performance, occasionally shows a lag phase in the first day (or two days) of a trial (Fig. 8.11-6). It is proposed that necessary formation of essential extracellular enzymes and/or changes

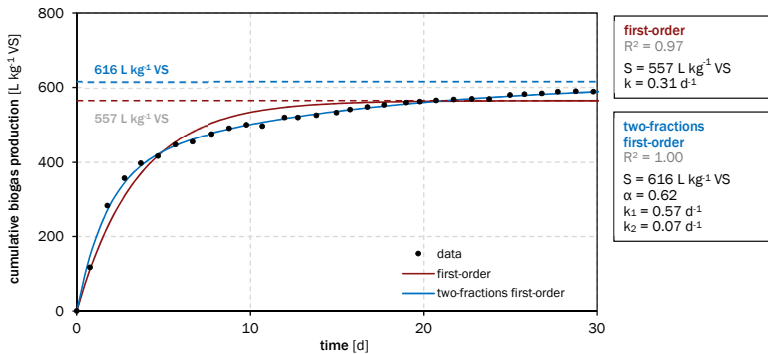

Figure 8.11-5: Model-based approximation of the specific biogas potential and reaction kinetics during discontinuous anaerobic degradation of maize silage

in the microbial community (adaptation of the inoculum to pure cellulose) can cause such delayed biogas production during anaerobic digestion of microcrystalline cellulose.

Due to its fundamental functional behaviour, single first-order kinetics – as well as extended approaches based on rapidly and slowly degradable substrate fractions – cannot depict specific biogas or methane production sufficiently ($R^2 \leq 0.93$). These approaches unavoidably predict a monotonic decrease in the rate of production over time. By applying a delayed first-order model and thereby moving the start point for process simulation to later times, the low gas production at the beginning of the experiment can be neglected. In the presented example a lag phase of 3.2 days (approximately 3 days and 5 hours) provides a reasonable fit for consecutive days ($R^2 = 0.94$, based on observations between 3 and 20 days). The modified GOMPertz model enables the best approximation of the respective experimental results ($R^2 = 1.00$). Generally, any sigmoidal expression such as basic logistic functions or hyperbolic tangent as well as first-order exponential kinetics (Eq. 5 in STRÖMBERG et al. 2015) will guarantee a close depiction of the specific process behaviour.

Whether batch tests with a significant lag phase can be utilised for valid substrate characterisation or serve as reliable indicator for process failure remains unclear. A pronounced delay of gas production during anaerobic degradation of easily degradable substrates most often indicates flaws in the experimental setup and applied procedures (KOCH et al. 2019). In this case, revision of the experimental protocol and measurement techniques is advised. Furthermore, adaption of the inoculum to the investigated substrate is recommended to reduce lag phase behaviour and enable immediate substrate degradation and biogas formation.

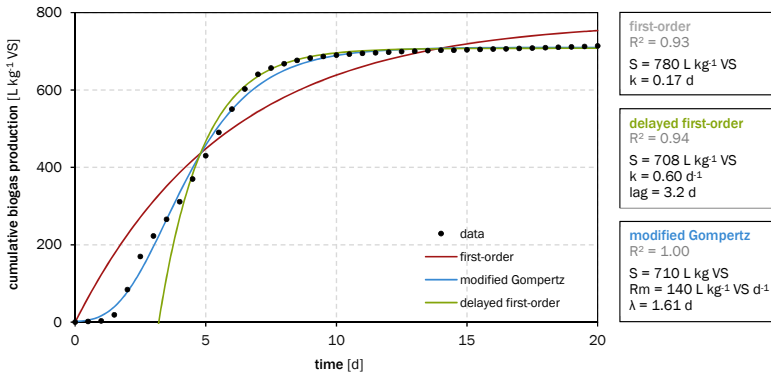

Figure 8.11-6: Parameter estimation during anaerobic digestion microcrystalline cellulose evincing a clear lag phase

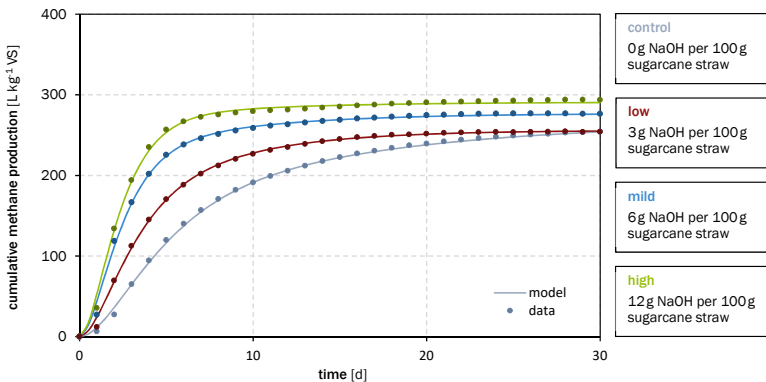

Figure 8.11-7: Experimental and simulation results during alkaline pre-treatment of sugarcane straw (based on JANKE et al. 2017)

Example 3: Investigating substrate pre-treatments

The third example is based on a study of JANKE et al. (2017) who investigated the effect of sodium hydroxide (NaOH) as an alkaline pre-treatment to enhance anaerobic degradability of sugarcane straw. Therefore, sugar cane straw was homogenised by milling to 2 mm particle size and pre-treated in NaOH solutions at various concentrations of 0, 3, 6 and 12 g NaOH per 100 g sugarcane straw. Specific methane yields and degradation kinetics were examined in anaerobic batch test and evaluated based on available model approaches (Fig. 8.11-7).

The best overall model fit was achieved by a two-step two-fraction reaction model (Eq. 114), estimating all five unknown parameter values for each substrate pre-treatment, respectively, Tab. 8.11-2. Due to the strong adjustability of the applied model structure, the estimation of different model parameters enables a precise description of the experimental measurements (including the maximum methane potential). However, the high number of model parameters complicates a clear interpretation and comparison of degradation kinetics between different samples. Simplified model structures such as single first-order kinetics (Eq. 111) enable a clear interpretation of the methane potential and degradation kinetics, but result in poor simulation results. Thus, the estimated parameters therefore do not represent the individual degradation conditions of the utilised substrates.

Table 8.11-2: Estimated parameter values (based on a two-step two-fractions model) during simulation of discontinuous anaerobic digestion of pre-treated sugarcane straw (according to JANKE et al. 2017) ^{a)}

	Variable parameters ^{b)}						Fixed parameters ^{c)}		
	S_{\max}	α	k_1	k_2	k_{VFA}	R^2	S_{\max}	α	R^2
Condition	[L kg ⁻¹ VS]	[-]	[d ⁻¹]	[d ⁻¹]	[d ⁻¹]	[-]	[L kg ⁻¹ VS]	[-]	[-]
Control	267 ± 18	0.57 ± 0.03	0.41 ± 0.01	0.08 ± 0.01	0.42 ± 0.03	1.00	260 ± 17	0.20 ± 0.01	1.00
Low	256 ± 07	0.59 ± 0.04	0.64 ± 0.18	0.17 ± 0.11	0.63 ± 0.19	1.00	260 ± 04	0.62 ± 0.07	1.00
Mild	277 ± 10	0.81 ± 0.03	0.78 ± 0.01	0.14 ± 0.01	0.80 ± 0.01	1.00	275 ± 09	0.93 ± 0.03	0.99
High	291 ± 10	0.92 ± 0.01	0.83 ± 0.01	0.1 ± 0.01	0.80 ± 0.01	1.00	291 ± 10	1.00 ± 0.01	0.99

a) Standard deviation based on estimated model parameters for three replicates of each pre-treatment (condition).

b) Optimal set of model parameter values of a two-step two-fractions model (Equation 114, derived by BRULÉ et al. 2014). All model parameters were adjusted during numerical parameter estimation.

c) Parameter estimation for fixed first-order degradation constants: $k_1 = 0.67$, $k_2 = 0.13$ and $k_{\text{VFA}} = 0.66$ in d⁻¹. Constant model parameter values were determined based on the respective mean of variable parameters values over all trials. Only S_{\max} and α were adjusted during numerical parameter estimation.

To reveal clear dependencies of different pre-treatments and still ensure reasonable simulation results, all three first-order degradation constants were fixed at their mean value over all trials. Thus, parameter estimation was repeated for fixed first-order reaction constants ($k_1 = 0.67$, $k_2 = 0.13$ and $k_{\text{VFA}} = 0.66$ in d⁻¹), adjusting the methane potential and share of degradable substrate in fraction 1 (S_{\max} and α) only. As shown in Tab. 8.11-2 the simulation results still evince a close process depiction ($R^2 \geq 0.99$). Furthermore, both model parameters can now be used for a clear characterisation of the respective degradation behaviour.

Whereas mild treatment did not change the methane potential (compared to the control sample), both model parameters (S_{\max} and α) are generally raising with increasing intensity of alkaline pre-treatment, Tab. 8.11-2. Thus, application of sodium hydroxide increases both gas potential and degradation kinetics (share of rapidly degradable substrate components) and thereby increases anaerobic degradability of sugarcane straw.

Fixing individual parameters during model adjustment is an effective way to enable a clear and transparent comparison of different types or pre-treatments of applied substrates and inocula. However, the direct transferability of respective results in batch operation to (semi-) continuously operated laboratory experiments or industrial plants is rarely investigated and still not proven (BATSTONE et al. 2009, JENSEN et al. 2011, WEINRICH & PRÖTER 2017).

Especially, the impact of the utilised inoculum on the resulting gas potential and degradation kinetics of different substrate pre-treatments remains unclear. Since substrate pre-treatment can change the availability of nutrients, the applied inoculum might behave differently depending on the strength and kind of applied technology (KOCH et al. 2017). To reduce uncertainty adaption of the inoculum to individual pre-treated substrates is proposed (WEINRICH et al. 2018).

Conclusions

Kinetic modelling is an essential component towards a standardised, comparable and transparent evaluation of anaerobic batch tests. Based on a close depiction of experimental measurements, the estimated model parameters as well as the respective simulation results can be used for

- estimation of the maximum biogas or methane potential (at infinite digestion time),
- description of substrate-specific degradation kinetics during discontinuous operation,
- direct and clear comparison of individual substrate or inoculum characteristics,
- detailed evaluation of experimental procedures (e.g. effect of inoculum on degradation kinetics) and operating conditions (e.g. discontinuous versus continuous operation), and
- efficiency evaluation based on the residual gas potential.

Model selection depends on the respective objectives for test conduction and individual experimental results. Thus, individual model functions cannot be applied in general. Complex models will most often provide the best fit. However, all estimated parameters need to be checked for validity and uniqueness (including impact of initial parameter values during parameter estimation). Thus, the simplest model that still enables close process description should be chosen. Furthermore, models based on first-order reaction kinetics enable a clear interpretation of degradation characteristics (kinetics and gas potential), which also can be transferred to evaluate continuous processes. If different substrates need to be compared, a single model structure for all experiments should be applied. Estimated model

parameters should be carefully reviewed and compared to available literature data or validated based on fundamental principles (e.g. mass conversion or stoichiometric calculations). In this way, kinetic modelling can aid the understanding and interpretation of anaerobic batch tests and should be included in basic protocols (guidelines) or applied during respective inter-laboratory tests to further improve experimental procedures in the future.

9 Calculation and assessment methods (parameters that describe processes/meta-parameters)

9.1 SWOT analysis

Christof Heußner, Oliver Kugelstadt, Tobias Bahr, Klaus Fricke, TU Braunschweig

The SWOT analysis (S-Strength, W-Weaknesses, O-Opportunities, T-Threats) is a tool that originates from the area of strategic management but is also used for formative evaluations and quality developments. This analysis method serves for deriving suitable strategic solution alternatives for the achievement of previously defined objectives from the strengths or weaknesses of an organisation or enterprise (internal view) and the opportunities and risks (external view), and presenting them clearly. The internal analysis is intended to make it possible to recognise strengths and weaknesses of a company – or, in this case, of a process. These result from the competencies, skills (and/or technical capabilities) and resources of the unit under review.

In the course of the external analysis, the closer and more distant environment of this unit is investigated. Only through the alignment with the environment (and/or the framework conditions) can strengths and weaknesses be weighted subsequent to a stocktaking and transitioned into options for action (LOMBRISER & ABPLANALP 1998).

The objective of the analysis consists of working out to what extent the strengths of the currently applied technologies and methods for the utilisation of the available biomass are suitable and – given the background of the current circumstances and those expected in the future – relevant. As a result, it becomes possible to react to the current and future needs based on the energetic and material utilisation of existing biomass. This objective is achieved by reworking the aforementioned sub-areas of the SWOT analysis.

The SW portion (strengths and weaknesses) deals with the internal factors. These are the technical options and development potentials of the method under review. Here, there are numerous forms of development that essentially result from the specifics of the individual case which, however, due to the viewpoint from which it is viewed, also feature a lot of commonalities. Therefore, a prior identification of decisive factors (so-called critical/key success factors), (PANAGIOTOU 2003), is helpful for the SW analysis. In relation to these factors, strengths and weaknesses are then checked. These factors or objectives must be defined before working on the actual analysis. In doing so, concrete and non-abstract objectives must be selected. Abstract objectives such as an increase of the energy efficiency must be put into concrete terms based on test results and must be evaluated by means of existing literature references and own assessments (LOMBRISER & ABPLANALP 1998).

Furthermore, it must be ensured that all identified strengths and weaknesses are relative. They only gain meaningfulness through a benchmarking against other methods or utilisation options. In the case of the energy efficiency, the method is – differing from traditional SWOT analyses – applied to a multitude of technical solutions and processes. The more

important it is therefore to find a suitable benchmark based on which the state of development (in particular the energy efficiency) of the individual processes can be categorised. For this, an objectivisation of the rather subjective factors of the individual results of the SWOT analyses is necessary.

1. Comparison of the respective processes to the best assessed plant on the market (real comparison);
2. Comparison of the respective processes to a hypothetical best practice plant by combining the best assessed sub-processes of multiple plants available on the market (hypothetical comparison – state of technology);
3. Comparison of the respective processes to a hypothetical best practice plant through idealised combination of optimised sub-processes taking into consideration the latest state of research (hypothetical comparison – state of research);
4. Comparison of the respective processes with a hypothetical theoretical approach. Reference here is the energy content as target parameter (100% efficiency) – exploratory comparison of fundamental utilisation variants (thermal utilisation, material utilisation, fermentation, ethanolation)

The OT portion (opportunities and threats) includes trends and changes that result from the general and specific circumstances for the respective process. To be considered to be external factors they must be those on which a company (in the case at hand, a plant operator or technology provider) does not have any direct influence. This could, for instance, be statutory regulations, limit values, or funding programmes (LOMBRISER & ABPLANALP 1998): Criteria are defined for both the internal as well as the external analysis that ensure a standardised approach and a comparable method response even in the case of the analysis of different processes for biomass utilisation (e.g. composting, fermentation, thermal utilisation). A compilation of superordinated criteria can be found in Tab. 9.1. These criteria are in turn refined by subordinate criteria (c.f. R&D potential and ecological framework conditions).

During the collection of the criteria, often the problem arises to what extent individual criteria are being categorised based on their importance and/or how important the criterion is with respect to the objective of the analysis. Furthermore, a multitude of criteria renders the subsequent analysis more difficult. In the categorisation of the criteria, SWOT analysis of the University of Warwick may serve as an exemplary model to follow (DYSON 2004). Here, the strengths, weaknesses, opportunities and threats are collected and subsequently assessed with a corresponding point scale. If a criterion does, for example, not reach a certain number of points, it is removed from the catalogue of criteria.

Table 9.1: Working draft of a catalogue of criteria for the internal and external part of the SWOT analysis (incomplete)

Criteria catalogue strengths/weaknesses analysis	Criteria catalogue opportunity/risk analysis
<ul style="list-style-type: none"> • General process characteristics: <ul style="list-style-type: none"> ○ Temperatures ○ Pressures ○ Corrosivity ○ Residues ○ Heat integration potential • Offer potential (products, services) • Distribution (collection and distribution) • Market communication • Prices and conditions • Procurement (educts, aids and operating resources) • Finances • Personnel • Management and organisation • R&D potential: <ul style="list-style-type: none"> ○ Amount of R&D investments ○ R&D know-how ○ Technical equipment ○ Patents and licenses ○ Access to external R&D sources/cooperations 	<ul style="list-style-type: none"> • Market structures • Competition • Statutory/state framework conditions • Societal framework conditions • Procurement of raw material (prices and supply) • Energy prices • Other economic conditions • Technological/technical development • Ecological framework conditions: <ul style="list-style-type: none"> ○ Air quality management ○ Water pollution control ○ Soil conservation ○ Waste disposal and avoidance ○ Energy utilisation ○ Utilisation of raw materials

From the actual SWOT analysis itself, no concrete measures are decided or implemented but rather first only states are described in relation to best case scenarios and in a subsequent step strategies are developed. To transition these strategic approaches into concrete measures, typically a concrete action plan is required (DYSON 2004). The plants to be reviewed are technically complex and feature different stages of treatment and levels of utilisation. For the identification of optimisation measure that are as effective as possible, the processor has permission to compare individual process steps (where applicable: individual aggregates) to the state of technology and derive optimisation potentials. The data necessary for this are captured at the plants in parallel to the SWOT analyses, specific values are bundled into groups and summarised in evaluation indexes.

9.2 Calculation of plant/process indexes (optimisation potential of individual process steps)

Christof Heußner, Oliver Kugelstadt, Tobias Bahr, Klaus Fricke, TU Braunschweig

Plant and process indexes serve for the assessment and comparison of individual process areas, plant components or treatment concepts and thus support the working out of optimisation potentials with respect to the treatment objective. For this, specific energy consumptions of fermentation and composting plants are recorded and weighted.

Based on the recorded data, the different plants are assessed individually (part A). For this, it is necessary to subdivide the process steps within the plant into main process stages in order to allow for a delineation from other process steps (part B). It is, for example, defined where the area of the feed ends and where the sorting starts.

The data of the separated process steps are standardised to a functional unit (e.g. 1 Mg total solids) in order to ensure comparability, and specific indicators are derived (e.g. specific thermal and/or electrical energy demand). Since it is to be expected that the specific energy consumption of large plants is lower than that of small plants, initially a categorisation based on the plant throughput is performed to establish comparability and to avoid distortions of the results. A final classification and categorisation is conducted after the recording of the underlying data.

Parts of the plant that do not correlate to the mass throughput are reviewed separately. This includes rooms and any buildings that cannot solely and directly be allocated to the plant operation such as the location's fire brigade, the administration, the central weighing station, the canteen, staff buildings, etc..

For the mass balance, the mass flows generated based on the type of plant are taken into consideration. This includes, for example, process water and exhaust air as well as the input and output of the processed substrate (part C). Furthermore, particularly process-relevant individual substances (special valuable materials or harmful substances) as well as valuable materials produced (for instance compost and other fertiliser substituents) are recorded for later analysis since they constitute an impact on the life-cycle assessment efficiency of the respective plant or process due to energy/raw material savings and/or consumption (in the case of substitution or utilisation of industry products that are using a lot of energy or of fossil resources). For the energy balance, the consumption data of thermal, electrical and chemical energy are recorded separately for individual aggregates or process steps.

The data determined in parts A–C is compiled into a data matrix. From this matrix, the minimum and maximum values for each mass and energy balance are determined. As such, the lowest individual value of the gas yield of all plants recorded is utilised as pessimism of the gas production potential and the highest one as optimum. With the help of these minimum and maximum values, an energy and/or mass indicator is calculated for each process step. Via this indicator it is possible to categorise the results of the energy and/or mass balance

of the process steps under review and to compare it to results of energy and/or mass balances of the same process of other plants (part D). Even for the same plant and the same process, different energy efficiencies may be achieved, for instance dependent on the current load or quality of the input materials. The processes may feature a different "minimal load capability" and may, for instance, become very inefficient at a reduced load. This is, for example, relevant in the case of a pronounced seasonality in quantity and/or quality of the input material. These differences are taken into consideration in the assessment, too. Energy and mass indicators are aggregated into a process indicator in a next step. This indicator allows for both the comparison of the energy efficiency of the same process in other plants as well as the relative comparison to other processes in the same plant (part E).

With an analysis, plant-internal optimisation opportunities can be determined on the one hand, while, on the other, allowing for comparisons to the same process in different plants. In a last step, a plant index is determined from the process indicators calculated (part F). The plant index allows for the classification of all systems relative to one another, wherein the model makes it possible to compare different types of plants (e.g. biowaste fermentation, composting) with one another. The model is designed such that through the utilisation of the specific minimum and maximum values of each energy and mass balance for each process step and standardisation is achieved that is independent of the type of plant analysed.

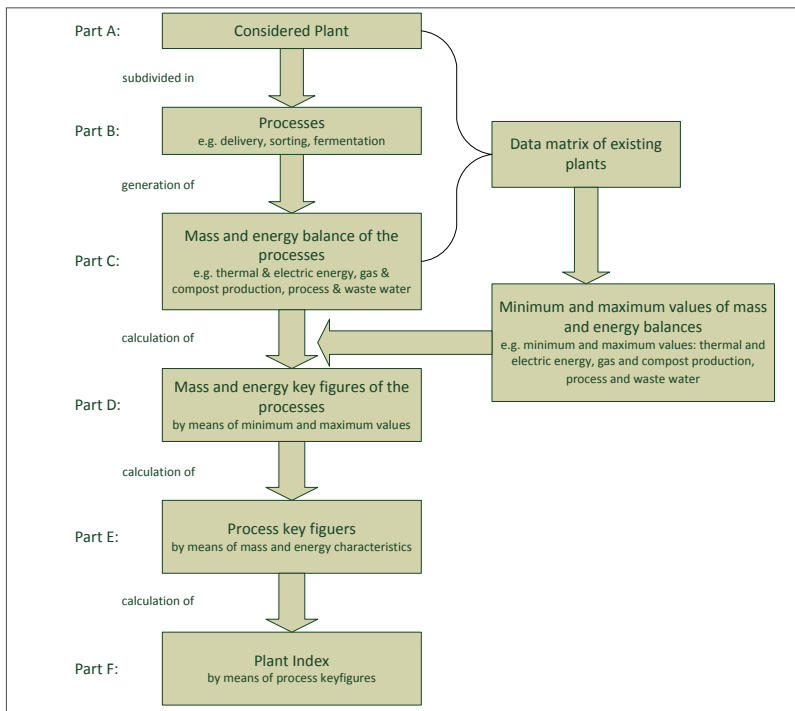

Figure 9.2-1: Schematic for the determination the plant index (Source: TU Braunschweig)

Systems with little or a lot of technical equipment remain in detail comparable to one another since each individual process step is compared to the same process step in other plants. In the calculation of the evaluation index, the lower number of individual plant-specific indicators for smaller or more simple plants is taken into consideration. Depending on the scope of the analysis, energy and mass balances of individual parts of the plant may be recorded down to individual aggregates and thus may feature a previously unachieved acuity and depth of analysis.

The maximum value utilised for the standardisation is a real best practice value that is taken from the data matrix, c.f. Fig. 9.2-1. In the sense of an ideal borderline case consideration, the real maximum value for the determination of the energy and mass indicators can be replaced by a hypothetical maximum value – determined from theoretical considerations and the latest research results. While the latter has not yet been implemented in practice, it does allow for an estimation of the best possible progress in the implementation of the current state of research.

This method of simulation can also be used for developing a plant with the latest state of technology (best practice approach). For this, for each energy and mass indicator the maximum value (from the data matrix, c.f. Fig. 9.2-2) is assumed, from which a maximum process indicator and/or plant indicator is calculated. In comparison to this indicator, the optimisation potential can be estimated for each plant since the maximum values in the case of this simulation consist of real, existing values. However, in the near future the frame of consideration can be expanded via the inclusion of currently hypothetical, yet realistically achievable energy efficiency of relevant plant components (state of research).

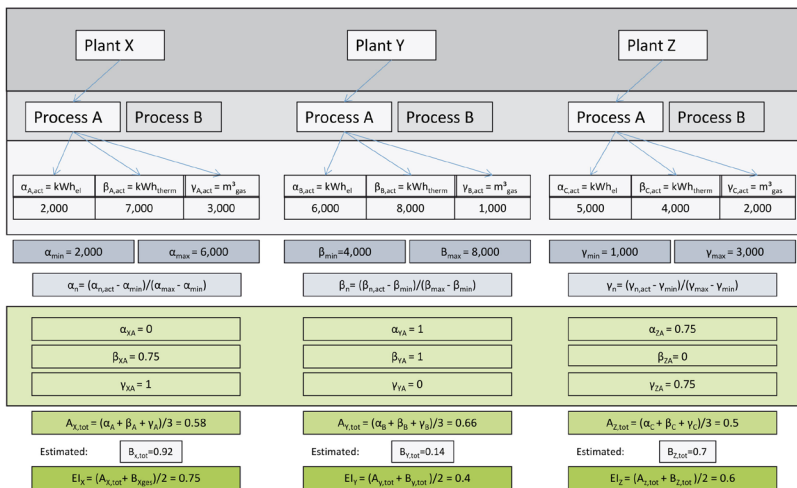

Figure 9.2-2: Mathematical depiction regarding the calculation of the plant index (both figures)
 (Source: TU Braunschweig)

Another important option for the utilisation of this model is the optimisation of individual plants. With the help of this model it can be determined which plant component features the greatest optimisation potential. This is possible because different processes become comparable to one another through standardisation. The higher the indicator, the more costly and expensive an optimisation of this process will be.

Database	e.g. plant X, plant Y
Breakdown of data according to the process stage and allocation of variables	e.g. delivery = A; fermenter = B; gas purification = C
Mass and energy balance of the process stages and normalization to 1 Mg _{input} ; allocation of variables	e.g. water consumption/Mg = α ; KW _{el} /Mg = β ; kW _{therm} /Mg = γ ; gas production/Mg = δ
Determination of the min/max-values for the mass and energy balances on the basis of the overall database	e.g. $\alpha_{\min}/\alpha_{\max}$; $\beta_{\min}/\beta_{\max}$
Calculation of the corresponding mass and energy indicator of the reviewed plant	e.g. $\alpha_n = (\alpha_{\text{act}} - \alpha_{\min})/(\alpha_{\max} - \alpha_{\min})$ n = variable of the process stage α_{act} = specific actual value of the corresponding plant act = actual
Calculation of the process key figure of the corresponding process stage of the reviewed plant	e.g. $A_{\text{tot}} = (\alpha_a + \beta_a + \gamma_a)/n_{\text{balance steps}}$ tot = total
Calculation of the evaluation index (EI) of the reviewed plant	e.g. $EI_x = (A_{\text{tot}} + B_{\text{tot}} + C_{\text{tot}})/n_{\text{process stages}}$

9.3 Determination of the effect of organic fertilisers on the humus supply of soils

Doreen Zirkler and Peter Dominik, TU Berlin

Status	The method introduced for the determination of the impact of organic fertiliser on the humus supply of soils (laboratory experiment) is modelled on ISO standard 16072: Soil quality – Laboratory methods for determination of microbial soil respiration (2001).
Associated standards	<ul style="list-style-type: none"> • ISO 10381-6:1993, Soil Quality – Sampling – Guidance on the collection, handling and storage of soil for the assessment of aerobic microbial processes in the laboratory • ISO 11274:1998, Soil Quality – Determination of the water retention characteristics • ISO 11465, Soil quality – Determination of dry matter and water content on mass basis – Gravimetric method • ISO 4796, Laboratory glassware
Area of application of the method	Applicable to all organic fertilisers and terrestrial soils. A soil with a $\delta^{13}\text{C}$ signal that differs from that of the fertiliser should be selected.
Limitations of the method	The plant roots that exist under natural conditions change soil chemistry and soil biology, which have an essential influence on the decomposition of organic matter. This aspect is not taken into consideration in the respiration experiment. The time span of incubation that is needed until the humus contribution of the fertiliser remains in the soil for longer periods is controversial.
Advantages	Compared to the VDLUFA method, the respiration method has the advantage that the effect of the organic fertiliser on the humus supply of soils does not only have to be gained from long-term field experiments in which a lot of other factors play an important role, too, but can be determined specifically for the given fertiliser and the corresponding soil. Furthermore, novel organic fertilisers that have not been listed in the VDLUFA position paper so far can also be tested. In comparison to field experiments, the respiration method is time and cost saving.
Need for research	The method can be improved by the simulation of plant roots. Currently, experiments are conducted to test the integration of ion exchangers as plant root substitute. Moreover the simulation of root exudates in respiration experiments should be developed and investigated.

Humus supply plays an important role for the fertility of soils. Humus increases the nutrient supply for plants as well as the water storage capacity and aggregate stability of the soil (VDLUFA 2004). In crop production, humus decomposition differs depending on agricultural measures such as tilling or liming, but also on specifics of the type of crop such as soil cover

duration. In contrast to natural vegetation, biomass is removed from the soil by harvesting. This deficit can be compensated for by returning organic residues such as harvest residues, slurry, manure, compost, but also biogas residues to the field.

In case an organic fertiliser provides insufficient or too easily degradable organic matter, the soil remains undersupplied with humus and the soil fertility decreases. In case it provides too much easily degradable and nutrient-rich organic matter, undesirable effects such as nutrient leaching or volatilisation (e.g. nitrogen) may occur (*ibid*). The extent of contribution of an organic fertiliser to the humus supply of soils can be tested in a variety of ways.

The VDLUFA method

The objective of the VDLUFA method (2004) is to estimate the organic matter supply of a field and to compensate deficits with organic fertilisers if necessary. The humus balance method regards humus dynamics as a balance, i.e. with inputs and outputs. For this, the humus demand of different crops and cultivation types is specified in kg humus-C ha⁻¹a⁻¹. This value can be positive (humus increasing) or negative (humus depleting). The derivation of these values was based on long-term tests and expert knowledge (DOMINIK *et al.* 2009). A negative value must be compensated for by the humus reproduction of organic fertilisers. The corresponding humus reproduction values of various organic fertilisers can be found in the VDLUFA position paper as well. They are specified in kg humus-C (t substrate wet weight/fresh matter)⁻¹. These humus reproduction values can be used for estimating the impact of organic fertilisers on the humus supply of soils. Although suggested by the unit (kg C_{org} *ha⁻¹*a⁻¹), actual changes of the humus reserves cannot be concluded from humus balances since the method neither takes local conditions such as type of soil and climate into account nor the former land use. Furthermore, changes of humus reserves are not linear but tend asymptotically to a new equilibrium. Thus it is possible that a specific location exhibits decreasing humus reserves, despite a positive humus balance. The VDLUFA method cannot be applied to ecological farming. For ecological farming, LEITHOLD & HÜLSBERGEN (1998) have developed the humus unit (HU) method. They indicate a higher humus depletion for crops than VDLUFA since no mineral N mineral fertilisers are used in ecological farming and the N supply for plants must be ensured by the mineralisation of soil organic matter (humus). Therefore, the demand for compensating reproduction-effective organic fertilisers is higher (FEDERAL ENVIRONMENTAL AGENCY 2008).

Determination in field experiment

The most exact method to determine changes of the humus content due to organic fertilisers are long-term field experiments. They take all influences of agricultural practice (such as crop rotation, tilling, sowing, harvest and weather conditions) into consideration. In field experiments, different (amounts of) fertilisers are applied to different field plots under otherwise identical test conditions, and the changes of humus content are measured. Since the humus contents of arable soils also vary locally and over time – the annual supply and decomposition of harvest residues can account for up to 10% of the humus reserves – the parameter must be measured over many years in order to give reliable results about changes of humus content and their direction. In each land use system with constant cultivation and climate, an equilibrium between humus supply and decomposition will establish

for a longer period, i.e. a stable humus content. A quantitative statement requires measurements for at least 20–30 years. As a result, this method becomes very expensive and is ill-suited for short-term predictions of the effect of novel organic fertilisers (such as biogas residues from renewable resources).

Determination in laboratory experiment

In respiration experiments at laboratory scale, the mineralisation time can be shortened by setting a temperature that is optimal for microorganisms. The number of days that are needed to get the same mineralisation efficiency as within one year in the field is called biological active time (BAT). It can be calculated with the help of the fine portion of the soil, the annual mean air temperature, and the annual amount of precipitation (FRANKO & ELSCHLÄGEL 1995).

In order to detect a priming effect, the soil used for the incubation should have a $\delta^{13}\text{C}$ signal different from that of the organic fertiliser. Soil and fertiliser are mixed with one another, adjusted to a water content of 40–60% of the maximum water holding capacity and filled into sealable vessels. A smaller open vessel containing a base (potassium hydroxide, KOH) (Fig. 9.3-1) is integrated in these vessels. The CO_2 emitted by the soil/fertiliser mixture is converted into carbonate ions in the base. The resulting increase in electrical conductivity is measured via electrodes installed in the base and converted into emitted CO_2 . During the incubation, the vessels are placed in a water bath at constant temperature and under exclusion of light.

If no respirometer is available, the amount of CO_2 released can also be determined via titration of the base. For this, the CO_3^{2-} is firstly precipitated with barium chloride (BaCl_2) as BaCO_3 . The rest of the base is titrated to pH 7 with a titration device or manually with hydrochloric acid (HCl) after addition of phenolphthalein. The amount of hydroxide ions neutralised during the titration in the base of the control (incubated soil without fertiliser) is deducted from the amount of hydroxide ions in the base of the soil/fertiliser sample. Subsequently, a conversion into CO_2 is carried out.

The shares of soil and fertiliser in the CO_2 emission can be gained by the determination of the $\delta^{13}\text{C}$ signal of the emitted CO_2 in the base and subsequent mixture calculation. The difference between the C amount of the fertiliser prior to incubation (measured by elemental analysis) and the amount of C emitted by the fertiliser corresponds to the amount of C added to the soil by the fertiliser. The corresponding humus content is given via multiplication with the factor 1.72 (SCHEFFER & SCHACHTSCHABEL 2002). The $\delta^{13}\text{C}$ analysis can furthermore reveal whether the fertiliser is triggering a so-called priming effect, i.e. whether the application of the fertiliser leads to a higher amount of mineralised soil C than in the control. If a soil with a $\delta^{13}\text{C}$ signal that differs from that of the fertiliser is not available, the sources of the emitted CO_2 (soil and biogas residue) cannot be determined quantitatively. In this case, the difference between the amount of C emitted by the soil/fertiliser sample and the amount of C emitted by the control is calculated. The result is finally deducted from the C amount of the fertiliser prior to incubation and multiplied with the factor 1.72 (see above). Any priming effects occurring cannot be identified this way.

A problematic aspect of the determination of the effect of organic fertilisers on the humus supply is that the mineralisation time required until a fertiliser is no longer decomposed quickly but is rather considered as long-term "humus effective" is controversial. It is recommended to include one or two well researched fertilisers (e.g. manure) as reference in the experiment for comparability and an approximate classification of the results (DOMINIĆ et al. 2009).

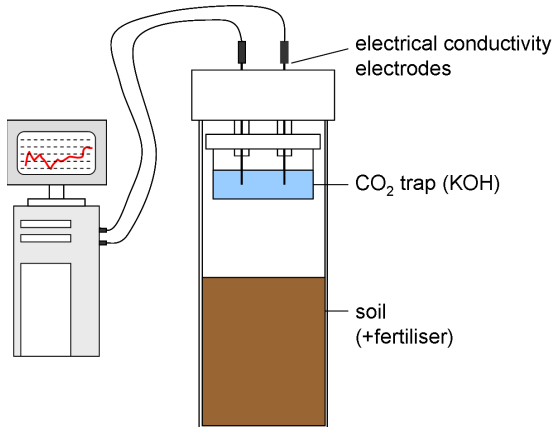

Figure 9.3-1: Example of a measuring cell of a respirometer

9.4 Mass balancing of biogas plants

Sören Weinrich, Jürgen Pröter, Josephine Hofmann, DBFZ; Jürgen Kube, Future Biogas Ltd

With increasing importance of energy production from biogas plants, the requirements posed to the description of the biogas process are increasing. In this, also moving into the foreground is the estimation of the potential biogas yield that is or can be produced as one of the most important criteria for the assessment of a biogas plant.

Different approaches exist in this for the presentation and assessment of the process engineering processes. Mass balancing (material balance), for example, provides the opportunity to assess the plant operation in dependence on: the respective amount and composition of the substrate used, the process engineering parameters as well as the metabolic activity of the microorganisms involved. In addition to the prediction of the biogas rates or the residual gas potentials, mass balancing therewith also allows for an optimisation of process control and constitutes the foundation for realistic plant sizing or economics calculation of biogas plants.

A direct, exact and comprehensive mass balancing is practical often not implementable since the measurement of the material flows entering and exiting as well as the kinetic reactions cannot be determined with justifiable effort or the technical foundations are missing. Nevertheless, a variety of methods already exist today to estimate the maximum biogas potential or the actual biogas yield in real plant operation.

Based on basic considerations, the different methods, options and uncertainties of mass balancing of biogas plants are detailed below.

Fundamentals of mass balancing

In order to be able to create a complete mass balance, a defined balance space must be specified in the beginning. Within the context of this short introduction, the balance or system boundary will encompass only a single reactor, Fig. 9.4-1. However, in the respective application case it is possible to apply the methods described here to a whole plant concept including substrate storage or multiple digesters.

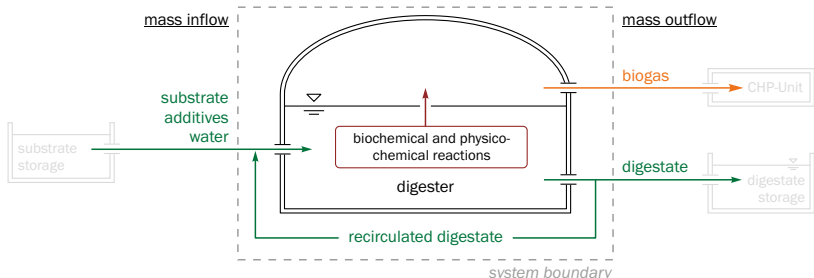

Figure 9.4-1: Mass balancing of a biogas digester (Source: DBFZ)

The masses fed to the system generally include the substrates and co-substrates utilised as well as additional additives (trace elements, enzymes or substances for binding H₂S) and water. The biogas generated and the digestate exit the process as discharged masses. If recirculation of digestate takes place, it may be reasonable to leave the return within the system's boundaries in order to not have to additionally balance the recirculate. In addition to the direct transport of substances across the system boundary, the different biochemical and physical-chemical conversion reactions of the individual groups of substances have a decisive impact on the mass balance of a biogas plant.

Based on these fundamental considerations, the general mass balance during stationary operation of a continuous reactor can therefore be formulated to:

$$\frac{dm}{dt} = 0 = \underbrace{\text{masses fed} - \text{masses discharged}}_{\text{transport via system boundary}} + \underbrace{\text{material conversion}}_{\text{biochemical reaction}}$$

124

However, under these conditions no statements can be made about the start-up and shut-down behaviour of a reactor or the dynamic operation at different load levels.

Supplied masses

Substrate

The material characterisation of the substrates fed is a core element during mass balancing of a biogas plant. The different substrates do not solely consist of organic components but also contain water as well as inorganic and non-fermentable components. Gasses dissolved in the substrate can generally be neglected for a rough mass balance.

Errors in the characterisation of different substrates therefore primarily occur already at the sampling as well as in the determination and interpretation of the individual measurement methods. In this, different parameters exist in order to be able to assess and balance the utilisation of different substrates:

Fresh matter (FM) (wet weight)

Based on the fresh matter/wet weight (FM) fed and discharged as well as the respective biogas production, a meaningful mass balance can already be prepared. Since a lot of the problems for substrate characterisation and material conversion listed below are avoided here, the wet weight is as such already a robust and sensible indicator for a practise-oriented balancing of an industrial-scale biogas plant.

Volatile solids (VS)

The determination of volatile solids is carried out based on standardised methods (Ch. 3.2). In the case of a high share of highly volatile substrate components, a total solids correction according to WEISSBACH must be performed (Ch. 3.3). In addition, volatile solids do contain non-fermentable components so that a further estimation of the non-fermentable components is necessary for the calculation of the substrate-specific biogas potential.

Fermentable volatile solids (FVS)

The fermentable volatile solids (FVS) describe the total solids actually degradable under anaerobic conditions. It can be calculated for selected substrates in first approximation according to WEISSBACH (2008, 2009). Since biochemical conversion (biogas production) of the applied substrates depend only on the actually fermentable substrate components, the estimation of the non-fermentable substrate components is an essential prerequisite for an essential reasonable mass balancing. Fundamentally, it is therefore important to further intensify the calculation, interpretation and utilisation of this indicator in practice. To date, standardised methods for analytical determination of the fermentable substrate components under practical conditions are still missing.

Feed analysis (Weender and van Soest analysis)

The feed analysis (c.f. Ch. 2 "Definitions" as well as Ch. 4.7–4.12) describes the applied substrates based on the different composition of carbohydrates (structural substances and cell contents), proteins as well as fats and thereby constitutes often the basis for a differentiated description of the stoichiometric degradation pathways of the different classes of nutrients. In addition to low comparability of measuring results due to different sample preparation and analytical methods, the assessment of the actually fermentable shares of the individual nutrients is of decisive importance here, as well.

Chemical oxygen demand (COD)

The chemical oxygen demand (COD) indicates the amount of oxygen that is needed for the complete oxidation of the existing organic compounds of the respective sample. Similar to the volatile solids, the COD is a measure for the organic substrate components, but is typically utilised for the assessment of highly diluted samples in the area of wastewater analysis. During anaerobic digestion of highly diluted substrates with a high share of volatile substances (for instance percolate) it may also be sensible to rely on the COD since obviously no meaningfulness is to be expected here that is based on a determination of total solids.

Total carbon (TC)

The total carbon (TC) content describes the sum of the carbon from all inorganic and organic compounds of the substrate. In particular, the total organic carbon (TOC) is often utilised, similar to the chemical oxygen demand (COD), for the characterisation of organic substrate shares in the area of wastewater analysis. Depending on the substrates and methods utilised, it is important to select the analytical parameters to be utilised based on the respective advantages and disadvantages with respect to the main objective of the mass balancing.

Additives

In practice, additives in the form of trace element mixtures, iron preparations or enzymes are utilised for stabilisation, desulphurisation or optimisation of the biogas process. Since the amount of such preparations utilised are often very small (< 0.1% of the total substrate feed), the proportion of weight within the masses fed can generally be neglected. Rather, these additives change the activity and degradation velocity of the microorganisms involved and thereby may have a decisive impact on the growth-limiting and/or inhibiting processes in the kinetic description of the biochemical conversion processes.

Water

If additional water is provided to the process in order to ensure the flow capacity of the substrates fed or of the digester content, it must be included in the balance. In this, the mass of water contained in the substrate is already included in the wet weight of the substrate fed (fresh matter) and can be removed calculatively based on the respective total solids content for the creation of a water balance.

Discharged masses

Biogas

During balancing of the amount of biogas produced, a clear definition of the measuring point as well as of the measuring conditions (temperature and pressure) of the biogas should exist. Since moist biogas exits from the reactor, it must be ensured that the gas is dried upstream of the measuring site and that the temperature of the gas is measured. Typically, the gas temperature will approach ambient temperature at the measuring site and will thereby deviate considerably from the digester temperature. In each case, a correction of the measured biogas to standard conditions and – where applicable – to dry biogas (steam correction) should be performed (STP).

From a reaction engineering point of view, a difference may exist between the biogas actually produced and the gas volume flow measured. This difference can be traced back to the fact that part of the biogas generated exists dissolved in the digestate. As such, the concentration of a gas in a liquid phase is directly dependent on the partial pressure of the gas and the substance-specific Henry constant. The temperature and the content of dissolved substances in the liquid also determine the solubility of a gas.

Digestate (fermentation residue)

In the characterisation of the digestate it must be taken into consideration that it does not consist solely of inorganic substances and water but rather additionally contains non-utilisable and non-convertible volatile solids as well as newly formed bacteria biomass. Furthermore, the digestate also contains portions of the generated biogas in dissolved form. The mass of salts contained in the digestate (inorganic VS or ash) corresponds approximately to the mass of the salts fed. This applies exactly to all heavy metals. In an analysis of these substances, the mass of the digestate can be derived in the case of knowledge of the mass of substrate fed. Fundamentally, the analytical methods of substrate assessment already discussed are available for the characterisation of the different components of fermentation residues.

Material conversion

In addition to the characterisation of the masses fed and discharged, the description of the material conversion of different substrate components is a central element of the mass balance. In this, the amount of biogas produced is influenced both by the biogas (formation) potential of the substrate utilised as well as the kinetic growth conditions of the microorganisms involved so that the determination of both elements is decisive for a realistic mapping of the balanced process. But since a comprehensive description of the individual degrada-

tion pathways and intermediate products is possible only based on elaborate measurement methods and kinetic modelling approaches, these scientific balancing methods are rarely utilised in practice and are furthermore – due to the multi-layered dependencies – not usable for generally applicable and practice-oriented process evaluation as part of this short introduction.

Nevertheless, in uninhibited and continuous (stationary) reactor operation, simplified calculation methods and balancing approaches can also be utilised for a practice-oriented process description. Therefore, the differentiated decomposition of individual intermediate products is neglected below and only the overall reaction (sum stoichiometry and kinetics) of organic substrate into biogas is considered. However, in the respective application case it must be taken into consideration that individual growth-limiting intermediates or inhibitors may severely inhibit the anaerobic digestion process and thereby may severely influence or relativise the meaningfulness of the balance.

Stoichiometry (biogas [formation] potential)

The biogas (formation) potential defines the biogas yield that maximally can be generated in the anaerobic digestion from the substrates utilised and must therefore not be mistaken for the actual biogas yield that can be achieved in real plant operation, taking into consideration the respective process conditions (retention time and reaction kinetics).

In principle, the biogas (formation) potential can be determined from experimental batch tests (c.f. Ch. 8.2) or otherwise base on stoichiometric calculations. But since the different test conditions (inocula/activity of the inoculum) and theoretical considerations (model substrates) differ considerably a comparability and/or transparency of the practical and analytical method does not exist to date. Generally, different stoichiometric equations exist for estimating the biogas potential based on the individual fermentable nutrient fractions.

BUSWELL & MÜLLER

The anaerobic degradation of organic model substances can be described by the simplified reaction equation (oxidation reaction) of BUSWELL & MUELLER (1952). Based on the individual coefficients from the stoichiometric formula of the respective substrate components and pure substances, the biogas potential (methane and carbon dioxide) as well as the needed water share can be calculated. The bacteria biomass generated is not taken into consideration in this approach.

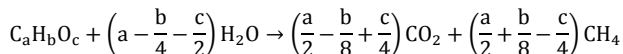

BOYLE

Starting from the reaction equation of BUSWELL & MUELLER (1952), BOYLE (1976) expanded the stoichiometric equation by the components nitrogen and sulphur. This way, in addition to carbon dioxide and methane, the share of ammonia and hydrogen sulphide in the biogas (and in solution) can be calculated. Furthermore, the calculation can now also be applied to substrate components that contain nitrogen and sulphur such as proteins and amino acids. However, the bacteria biomass generated continues to not be taken into consideration in this approach.

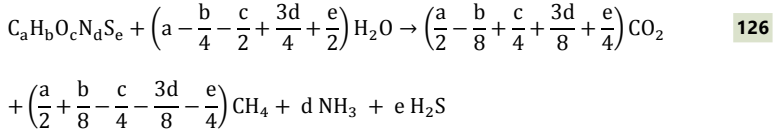

126

McCARTY

To additionally map the share of the bacteria biomass generated, the reaction equation of BOYLE (1976) can be expanded, modelled after McCARTY (1972) in PAVLOSTATHIS & GIRALDO-GOMEZ (1991), by the empirical formula $C_5H_7O_2N$ of microbial biomass. In this, the stoichiometric yield coefficient α specifies how much substrate is utilised for the creation of bacteria biomass (Eq. 127).

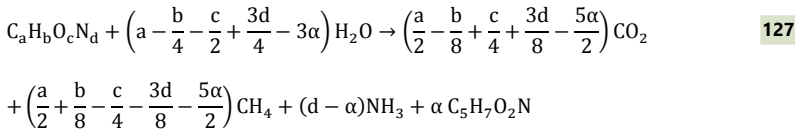

127

$$\text{Mit } \alpha = Y \cdot \frac{M_s}{M_x} \left[\frac{\text{mol biomass}}{\text{mol substrate}} \right]$$

Y = yield coefficient [kg biomass/kg substrate]
 M_s = molar mass of the substrate [kg/mol]
 M_x = molar mass of the biomass [kg/mol]

In addition to the introductory examples, comprehensive stoichiometric balances exist which describe the differentiated decomposition of the different intermediate products of anaerobic digestion (ANGELIDAKI et al. 1999; BATSTONE et al. 2002). In this, all methods depend on classifying the substrate mixture fed such that the individual substrate components can be characterised as close to reality as possible based on stoichiometric formulas, and can furthermore also be determined analytically.

Due to different model substrates and test methods, a variety of biogas potentials exist in the literature for the typical nutrient fractions, Tab. 9.4-1.

Table 9.4-1: Biogas (formation) potential of the fermentable nutrient fractions (adopted from WEISSBACH 2009)

	(WEISSBACH 2009) ^a		(WEILAND 2001)		(VDI GUIDELINE 4630 2016) ^b		(BASERGA 1998)	
	Biogas [L(STP) kg ⁻¹]	CH ₄ [%]	Biogas [L(STP) kg ⁻¹]	CH ₄ [%]	Biogas [L(STP) kg ⁻¹]	CH ₄ [%]	Biogas [L(STP) kg ⁻¹]	CH ₄ [%]
Carbohydrates	787–796	50.0–51.1	700–800	50–55	750	50	790	50
Fats	1,340–1,360	70.5–71.3	1,000–1,250	68–73	1,390	72	1,250	68
Proteins	714–883	50.9–51.4	600–700	70–75	793	50	700	71

^a Calculated for grains and cereals

^b ... "without taking into consideration the bacterial biomass production from the fermented substrate" (VDI GUIDELINE 4630 2016)

Fundamentally, it is of decisive importance that the whole biogas (formation) potential is calculated solely based on the actual amount of fermentable substrate components. In this, the calculation utilising the digestion factors from the classic feed(ing) value tables often provides very inaccurate results, so that the fermentable substrate components must be determined based on the non-fermentable shares according to WEISSBACH (2008, 2009). Depending on the stoichiometry utilised, an additional correction of the biogas potential due to additionally produced bacteria biomass must also be performed.

Reaction kinetics

For a comprehensive and differentiated consideration of the microbial growth kinetics in the different decomposition stages during anaerobic digestion, complex model considerations are necessary (ANGELIDAKI et al. 1999, BATSTONE et al. 2002). Instead, in the case of a disruption-free operation, the biogas yield can also be calculated based on simple first-order reaction kinetics. As such, the concentration of any substrate component is obtained in dependence on the reaction constant and the respective retention time in continuous and stationary reactor operation, in:

$$c = \frac{c_{in}}{1 + k \cdot \text{HRT}} \left[\frac{\text{kg}}{\text{m}^3} \right]$$

128

c_{in}	Substrate concentration in the input	kg m ⁻³
k	First-order reaction constant	1 d ⁻¹
HRT	Average hydraulic retention time	d

Depending on the substrates, test conditions and models utilised, a multitude of different and at times contradictory kinetic constants exists in literature, so it is important in the future to develop a systematic and practice-oriented foundation for the selection and calculation (identification) of representative kinetic parameters of different substrates and/or substrate components.

Summary

Mass balancing provides a variety of options allowing for the assessment or forecasting of the substrate decomposition in a biogas plants. Even if comprehensive model approaches are necessary for a complete description of the anaerobic digestion process, the methods described above can already be utilised for a meaningful and – more importantly – practice-oriented balancing. Using the research regarding substrate assessment by WEISSBACH as a starting point, a considerable need for research continues to exist regarding the following questions:

- Development of standardised, experimental or analytical methods for the calculation of fermentable volatile solids (FVS) and individual substrate components
- Development of suitable methods for the characterisation and/or stoichiometric description (chemical formula) of practice-relevant and complex substrates
- Comparability of the experimental (batch test) and theoretical (stoichiometry) methods of testing the biogas (formation) potential of different substrates
- Impact of different disintegration methods on the biogas potential and degradation kinetics
- Application of simplified kinetic modelling approaches for the description of fundamental reaction engineering and process-engineering processes at laboratory scale and transfer (upscaling) to full-scale industrial biogas plants
- Experimental test series regarding the identification of kinetic parameters of simple degradation reactions (first-order) of practice-relevant substrates
- Impact and quantification of the activity of the microorganisms involved (inoculum) on the meaningfulness and comparability of standardised batch tests based on reaction engineering and micro-biological tests
- Amount and impact of the bacteria growth and decay on the mass balancing of a biogas plant
- Impact of the solubility of gas components produced (carbon dioxide)

As such it is important in the future to include these essential approaches through further theoretical and practical research in a standardised and practice-oriented mass balancing approach in order to allow for an improved and close to reality assessment, optimisation and sizing of biogas plants with the help of reaction engineering balancing methods.

Example of a mass balance (WEINRICH 2014)

In conclusion, the principle of a straightforward mass balancing based on a practice-focused example for the mono fermentation of maize silage in a single-stage biogas plant (500 kW_{el}) is presented (WEINRICH 2014). The specific substrate characteristics of the maize silage utilised correspond to the average analysis values of various analyses at the German Biomass Research Centre (DBFZ), Tab. 9.4-2.

In accordance with common practice, the total solids content of the maize silage is being diluted via process water in the form of separated recirculate or fresh water in order to ensure pumpability and stirrability in the digester, Fig. 9.4-2.

Table 9.4-2: Substrate characteristics of the maize silage utilised for the calculation example (WEISSBACH 2009)

Parameters	Symbol	Value	Unit of measure
Total solids	TS	33.5	% FM
Organic dry matter (volatile solids)	VS	95.6	% TS
Fermentable organic dry matter/volatile solids ^a	FVS	78.5	% TS
Nitrogen-free extracts	NFE	626.1	g kg ⁻¹ TS
Crude fibre	CFI	221	g kg ⁻¹ TS
Crude protein	CP	78.8	g kg ⁻¹ TS
Crude fat	CF	29.6	g kg ⁻¹ TS
Crude ash	CA	44.5	g kg ⁻¹ TS

^a Calculated with CA and CFI according to WEISSBACH (2008)

Under the assumption that 5% of the FVS are incorporated into bacteria biomass, the stoichiometric calculations according to BUSWELL & MUELLER for grains and cereals on average result in a gas production potential of 809 m³ biogas and 420 m³ methane per t of converted FVS (WEISSBACH 2009). The corresponding stoichiometric integration of water into biogas amounts to 11.25%. Based on the fermentable components of the substrate fed, the specific conversion of the FVS as well as the resulting amounts and characteristic properties of the generated fermentation products (biogas and digestate) in the case of stationary plant operation can be calculated unambiguously, Equations 129–133.

As such, straightforward mass balancing provides a variety of options allowing for the assessment or forecasting of the substrate decomposition in a biogas plant. Even if comprehensive model approaches and measuring scenarios are possible for a detailed description of the decomposition processes and intermediate products, the calculation methods described here above can already be utilised for a meaningful, robust, and – more importantly – practice-oriented balancing.

In the following calculation equations for the mass balancing of biogas plants (WEINRICH 2014) are given.

Options for the calculation of the conversion η of FVS in the biogas process

Biogas yield:

$$\eta = \frac{\dot{V}_B}{\dot{m}_S \cdot TS_S \cdot FVS_S \cdot Y_{FVS}} \quad 129$$

Residual gas potential:

$$\eta = \frac{TS_S \cdot FVS_S \cdot Y_{FVS} - Y_D}{TS_S \cdot FVS_S \cdot Y_{FVS} \cdot (1 - Y_D \cdot \rho_B)} \quad 130$$

Reaction kinetics:

$$\eta = \frac{k \cdot HRT}{1 + k \cdot HRT} \quad 131$$

VS in digestate:

$$\eta = \frac{1}{FVS_S \cdot (1 - f_X)} \cdot \left(1 - \frac{1 - VS_S}{1 - VS_D}\right) \quad 132$$

TS in digestate:

$$\eta = \frac{1}{FVS_S \cdot [1 - f_X - TS_D \cdot (1 - f_X + f_W)]} \cdot \left(1 - \frac{TS_S}{TS_D}\right) \quad 133$$

FVS_S	Fermentable organic volatile solids (also referred to as fermentable organic dry matter) of the substrate mix	kg FVS kg ⁻¹ TS
f_X	Microbial biomass formation	kg biomass kg ⁻¹ FVS
f_W	Stoichiometric water incooperation	kg water kg ⁻¹ FVS
HRT	Hydraulic retention time	d
η	Conversion of FVS	kg FVS kg ⁻¹ FVS
\dot{m}_S	Mass flow of the substrate mix	kg d ⁻¹
ρ_B	Density of the biogas (STP)	kg m ⁻³ (STP)
TS_D	Total solids of the digestate	kg TS kg ⁻¹ FM
TS_S	Total solids of the substrate mix	kg TS kg ⁻¹ FM
VS_D	Volatile solids (also referred to as organic dry matter) of the digestate	kg VS kg ⁻¹ TS
VS_S	Volatile solids (also referred to as organic dry matter) of the substrate mix	kg VS kg ⁻¹ TS
Y_D	Specific residual gas potential (STP)	m ³ (STP) kg ⁻¹ FM
Y_{FVS}	Biogas (formation) potential of fermentable organic volatile solids (STP)	m ³ (STP) kg ⁻¹ FVS
\dot{V}_B	Volume flow (rate) of the biogas (STP)	m ³ (STP) d ⁻¹

Calculation of the resulting amounts and properties of the fermentation products

$$\dot{V}_B = \frac{\dot{m}_S \cdot TS_S \cdot FVS_S \cdot \eta \cdot (1 - f_X + f_W)}{\rho_B} = \dot{m}_S \cdot TS_S \cdot FVS_S \cdot \eta \cdot Y_{FVS} \quad 134$$

$$Y_D = \frac{TS_S \cdot FVS_S \cdot (1 - \eta) \cdot (1 - f_X + f_W)}{[1 - TS_S \cdot FVS_S \cdot \eta \cdot (1 - f_X + f_W)] \cdot \rho_B} = \frac{TS_S \cdot FVS_S \cdot (1 - \eta) \cdot Y_{FVS}}{1 - TS_S \cdot FVS_S \cdot \eta \cdot Y_{FVS} \cdot \rho_B} \quad 135$$

$$\begin{aligned} \dot{m}_D &= \dot{m}_S \cdot [1 - TS_S \cdot FVS_S \cdot \eta \cdot (1 - f_X + f_W)] \\ &= \dot{m}_S \cdot (1 - TS_S \cdot FVS_S \cdot \eta \cdot Y_{FVS} \cdot \rho_B) \end{aligned} \quad 136$$

$$VS_D = \frac{VS_S - FVS_S \cdot \eta \cdot (1 - f_X)}{1 - FVS_S \cdot \eta \cdot (1 - f_X)} \quad 137$$

$$TS_D = \frac{TS_S - TS_S \cdot FVS_S \cdot \eta \cdot (1 - f_X)}{1 - TS_S \cdot FVS_S \cdot \eta \cdot (1 - f_X + f_W)} \quad 138$$

$$FVS_D = \frac{FVS_S \cdot (1 - \eta)}{1 - FVS_S \cdot \eta \cdot (1 - f_X)} \quad 139$$

FVS_D	Fermentable organic volatile solids (also referred to as fermentable organic dry matter) of the digestate	kg FVS kg ⁻¹ TS
FVS_S	Fermentable organic volatile solids (also referred to as fermentable organic dry matter) of the substrate mix	kg FVS kg ⁻¹ TS
f_X	Microbial biomass formation	kg biomass kg ⁻¹ FVS
f_W	Stoichiometric water incooperation	kg water kg ⁻¹ FVS
η	Conversion of FVS	kg FVS kg ⁻¹ FVS
\dot{m}_D	Mass flow of the digestate	kg d ⁻¹
\dot{m}_S	Mass flow of the substrate mix	kg d ⁻¹
ρ_B	Density of the biogas (STP)	kg m ⁻³ (STP)
TS_D	Total solids of the digestate	kg TS kg ⁻¹ FM
TS_S	Total solids of the substrate mix	kg TS kg ⁻¹ FM
VS_D	Volatile solids (also referred to as organic dry matter) of the digestate	kg VS kg ⁻¹ TS
VS_S	Volatile solids (also referred to as organic dry matter) of the substrate mix	kg VS kg ⁻¹ TS
Y_D	Specific residual gas potential (STP)	m ³ (STP) kg ⁻¹ FM
Y_{FVS}	Biogas (formation) potential of fermentable organic volatile solids (STP)	m ³ (STP) kg ⁻¹ FVS
\dot{V}_B	Volume flow (rate) of the biogas (STP)	m ³ (STP) d ⁻¹

Calculations scheme

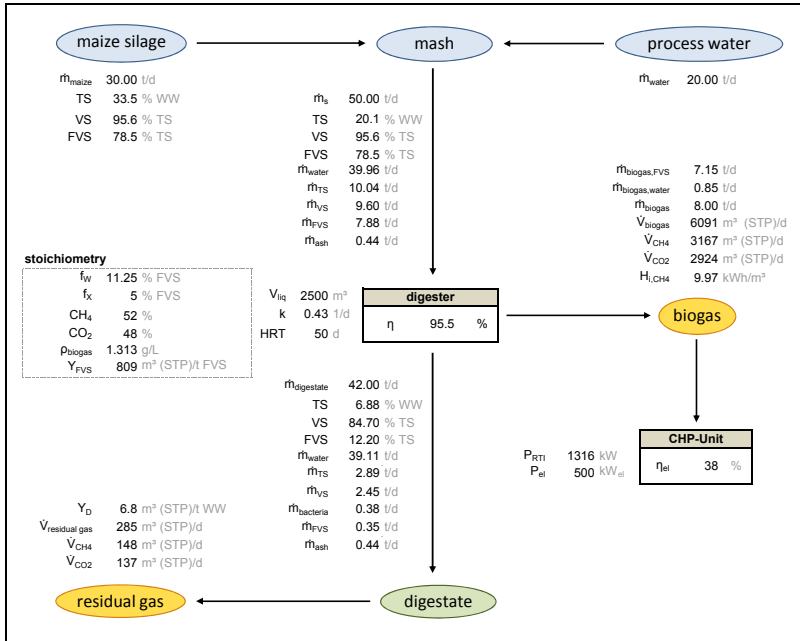

Figure 9.4-2: Calculation scheme of a straightforward mass balancing for the mono fermentation of maize silage (WEINRICH 2014)

9.5 Load detection and process control using gas analysis and fuzzy logic

Ernst Murnleitner, Michael Landa, Awite Bioenergie GmbH

Status	Commercially applied
Standard	IEC 61131-7 Programmable controllers Part 7: Fuzzy control programming
Area of application	Biogas plants
Disadvantages	<ul style="list-style-type: none"> Control equipment is needed. Certain degree of automation is needed.
Advantages	<ul style="list-style-type: none"> Reduced need of supervision
Need for research	<ul style="list-style-type: none"> Incorporation of alternative measurement methods

Control Aspects

Biogas plants need supervision by experienced operators to adjust parameters like substrate feeding and flow or CHP load to ensure a stable microbiology and optimum performance. This effort can be reduced considerably by automation using an expert system in combination with robust sensors. Such a system however is only helpful and accepted if the maintenance effort is low. This can be achieved by using both, robust measurement principles and robust control methods. Measurement of component concentrations in the liquid phase would be rather direct but is cumbersome because the matrix is very complex and contaminates submersed sensors. Only a few components enter the gas phase that is in equilibrium with the liquid. It may be advantageous to measure the gas composition and to build a control system based upon this as the gas is the desired product. Some of the knowledge of experienced biogas operators can be expressed in "IF-THEN" rules. The combination of such rules, fuzzy ("not sharp") variable descriptions and rules for the description of the dependence of those, are called fuzzy logic.

Fuzzy rule base

Fuzzy logic is a superset of conventional logic, which was extended in order to handle the concept of partial truth, values between completely true and completely false. Fuzzy rule-based systems (= fuzzy logic expert system) are used when knowledge on the input/output behaviour of a process is available but cannot (or should not) be put into a pure mathematical form. This is explained with the following example. If a fermenter is overloaded, it is likely that the hydrogen content is high because the acidification steps that produce hydrogen are faster than the methanogenesis.

Although input variables could be directly connected to output variables, like "IF hydrogen IS high THEN feed IS less_feed" or "IF methane IS high and hydrogen IS low THEN feed IS more", the presented system was designed in a way (Fig. 9.5-1) that the state of the system is described first and from this state the measures are derived, like Rule (1-1) and Rule (2-1).

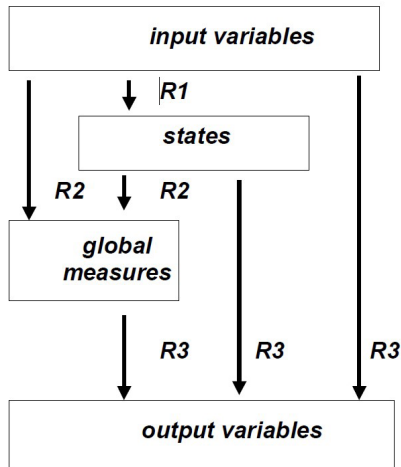

Figure 9.5-1: Structure of the multilevel fuzzy-logic rule base. Rule-levels R1, R2, R3 are calculated consecutively. R1: rule for calculating states; R2: rules for calculating global measures; R3: rules for calculating output variables

IF hydrogen IS high THEN state IS overload; Rule (1-1)

IF state IS overload THEN feed IS no_feed; Rule (2-1)

The hierarchical structure makes it easier to adapt the system to different plants or to introduce new measured values without the need of changing the whole system.

The following rule can be added as overloaded fermenters often have a low pH value.

IF pH IS low THEN state IS overload; Rule (1-2)

The rule base has to be completed with rules for the complementary “fuzzy sets” like “shortage” and “normal”:

IF methane IS high AND hydrogen IS low THEN state IS shortage; Rule (1-3)

IF methane IS not_low AND NOT (hydrogen IS high) THEN state IS normal; Rule (1-4)

One strength of fuzzy control is its robustness, because several rules can be used in order to set the same set of an output variable. If one rule drops out because of a defective sensor for example, other rules will still be active. The influence of a wrong input value amongst

several correct values however depends on the used methods for fuzzyfication, inference and defuzzification. Here common settings are used (MAX and-aggregation, PRODUCT aggregation, MAX accumulation; see MURNLEITNER (2001).

Imagine the Rule (2-1) mentioned above together with the following rule (2-2), which uses the productivity that is defined as the quotient of the produced gas and the required gas production and where a quotient of 1 is regarded as optimal, it may happen that the fermenter is already overloaded (Rule 2-1) while the operator's objective is to produce more gas and therefore the productivity is too_low (Rule 2-2). Here both rules would become active and set the feed to "no_feed" and to "more" each to a certain degree, depending on the overload state of the fermenter, e.g. too high and its productivity state, e.g. too low. The result is a compromise which would keep the feed somehow at the current level until the overload rises and the rule 2-1 becomes stronger.

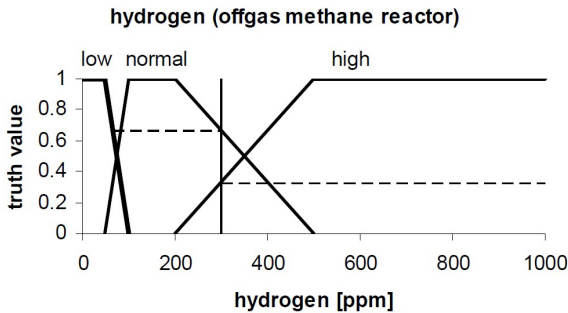

Figure 9.5-2: Fuzzy input variable for hydrogen showing a measurement value of 300 ppm, which is 67% normal and 33% high

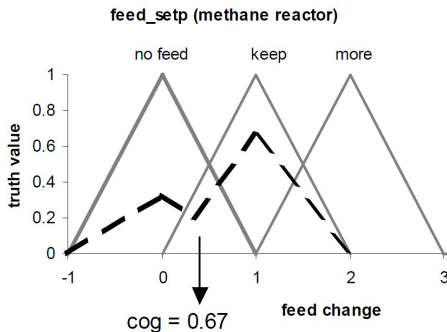

Figure 9.5-3: Fuzzy output variable for feed that gives a defuzzified value of 0.67 (using the center of gravity method)

IF productivity IS too_high THEN feed IS no_feed; Rule (2-2)

In practice the rule 2-2 was split into 3 rules which made the system more conservative, as the feed is not increased if there is an overload.

IF state IS normal AND productivity IS too_high THEN feed IS no_feed; Rule (2-2a)

IF state IS normal AND productivity IS optimal THEN feed IS keep; Rule (2-2b)

IF state IS normal AND productivity IS too_low THEN feed IS more; Rule (2-2c)

Not only proper rules have to be defined but also the definitions of the fuzzy sets like “normal”, “more” etc.

Fuzzy Sets

Every “sharp” numerical value of the specific input variables (e.g. “300 ppm hydrogen”) is fuzzified whereby the individually defined fuzzy sets (e.g. “low”, “medium”, “high”) of the fuzzy variable become true for a certain degree (truth value).

According to IEC 61131-7 the fuzzy input variable hydrogen (Fig. 9.5-2) is declared as

```

FUZZIFY hydrogen
  TERM low := (0,0), (1,1), (50,1), (100,0);
  TERM medium := (50,0), (100,1), (150,1), (500,0);
  TERM high := (150,0), (500,1);
END_FUZZIFY
  
```

After applying the rules, the final output variable for feed could look like (Fig. 9.5-3). Hence, the feed would be lowered for the next period in this example.

Extension - Gas management

The aforementioned rules were used for ten years in the automation systems of many bio-gas plants but recently the system was extended for controlling not only the feed rate but also the set point of the CHP power ($a1_setval$). If the short-term average of the CHP power could not reach the desired value, the CHP should run with more power (Rule 3-1).

IF $a1_load$ IS too_low THEN $a1_setval$ IS high; Rule (3-1)

If the gas bag is rather full (pressure is already high or level is high), the CHP should also consume more gas and vice versa (Rules 3-2 to 3-6)

IF gas_pressure IS high THEN a1_setval IS high; Rule (3-2)

IF (NOT gas_pressure IS high) AND (gas_level_avg IS high) THEN a1_setval IS high; Rule (3-3)

IF (NOT gas_pressure IS high) AND NOT (a1_load IS too_low) AND (gas_level_avg IS low) THEN a1_setval IS low; Rule (3-4)

IF (gas_level_avg IS medium) AND (NOT gas_level_avg2 IS high) THEN a1_setval IS high; Rule (3-5)

IF (NOT gas_pressure IS high) AND (gas_level_avg IS medium) AND (gas_level_avg2 IS high) AND (NOT a1_load IS too_low) THEN a1_setval IS medium. Rule (3-6)

The behaviour of these rules can be analysed taking all conditions of the biogas plant into consideration. The following example shows the operation of a biogas plant in the period of 10 days, where breakdowns of the feeding system disturbed the system (H1- and H2- in Fig. 9.5-4).

At “H1-“, the solid dosage stopped (until “H1+“) and the fermenter, which was not overloaded, reacted relatively fast with less gas production. The gas storage level decreased and therefore, the CHP power was reduced by the Fuzzy logic system as the average filling level also decreased (A1 in the Fig. 9.5-4).

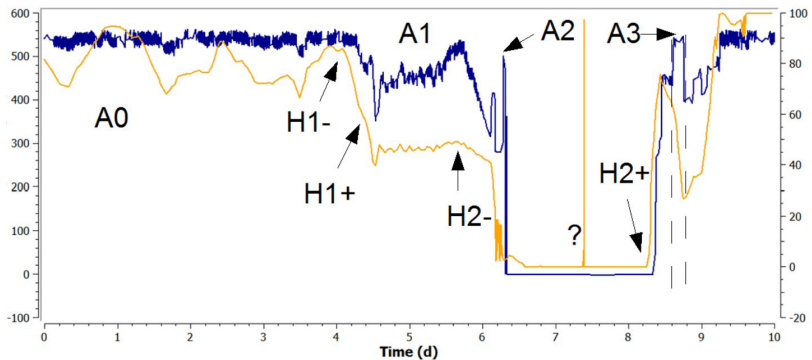

Figure 9.5-4: CHP power (left y-axis; A, dark (blue) vs. gas storage level (right y-axis, H, orange). A0: CHP runs with full power, A1: reduced power, A2 and A3: see text.; H1-, H2-: stop of substrate dosage; H1+, H2+: restart of substrate dosage

As the rules use the moving average of the gas storage level, the CHP power does not immediately increase if the gas storage level increases again. At “H2-“ the dosage stopped again for a longer period. . Therefore, the gas production collapsed completely. Finally, the CHP had to be switched off as its performance was only allowed to be reduced to 50%.

At “A2” and “A3” there are peaks of the CHP power due to the rules 3-5 and 3-6, which had been introduced in order to operate the CHP with a higher efficiency at certain conditions. Here a shorter term average (`gas_level_avg`) is compared with a longer term average (`gas_level_avg2`).

Experience

The presented system runs at more than 10 biogas plants. The feed suggestions are automatically taken over within the limits of a corridor set by the plant operator. Control of the CHP power is not implemented at all plants.

Limitations

Typical limits for minimum and maximum feed rates are +/- 50% of the average daily feed rate. At one biogas plant it was observed that the hydrogen concentration in the gas increased steadily up to more than 500 ppm and did not reduce. This resulted in a “stop feed” suggestion, as a high hydrogen concentration in the gas is regarded as an indicator for an potential overload of the plant (MURNLEITNER 2001). At 10% of the gas storage level the minimum allowed feed rate was limited to 90% of the average daily feed rate by the operator. This state was kept for 8 weeks before the feed had to be stopped for 2 days due to a breakdown of the CHP engine. The hydrogen was “normal” again after restarting the feeding. Chemical analysis did not show high concentrations of volatile fatty acids and therefore there might not have been an overload at all.

Conclusions and Outlook

CHP power and the substrate feed control works well under normal conditions. It would be desirable to measure the state of the fermenter with redundant measurements, especially to prevent wrong decisions of the systems due to unusual process states as described above. If additional knowledge and sensors become available, the rules could be extended accordingly. As flexible operation becomes more and more important, the system will be developed further.

10 Innovative test equipment and instruments

10.1 Measurement of H₂ (dissolved - gaseous)

Jens Zosel, KSI

Status	Prototype available
Associated standards	<ul style="list-style-type: none"> ● Gas-analytical measurement methods ● Sampling from biological media ● Extraction of dissolved gases
Area of application of the method	Measurement of the partial pressure of the dissolved hydrogen and other dissolved gases such as oxygen and methane
Substrates/ materials	Liquid and pulpy substrates in anaerobic and aerobic fermentation processes
Limitations of the method/disadvantages	Lower limit of detection: 1 vol.-ppm for the aforementioned gases in the extracted gas mixture
Advantages	<ul style="list-style-type: none"> ● <i>In-situ</i> measurement method ● Quasi-continuous recording of measuring data ● Calibration-free detector ● High long-term stability ● High selectivity and sensitivity
Need for research	<ul style="list-style-type: none"> ● Measurement of gas solubility in different substrates ● Integration of additional volatile components ● Further automation of the method

Issue at hand

Sensors for the online monitoring of biogas plants and complex control processes for the optimisation of the biogas production from liquid biogenous media are increasingly gaining in importance. For this, robust, long-term stable sensors are required that can be utilised in the liquid phase and gas phase of biogas plants at ambient temperatures of up to 55 °C and pressure of up to 2 bar. In particular, they also have to feature a high sensitivity and selectivity in the case of the presence of highly corrosive components in the liquid phase, e.g. of hydrogen sulphide and organic acids.

Approaches and results

Dissolved hydrogen

The hydrogen dissolved in biogas media is quantified both with membrane-covered amperometric sensors (ZOSEL et al. 2008) as well as with a novel measuring system in which the hydrogen is extracted from the liquid phase and subsequently determined in the gas phase (SCHELTER et al. 2011).

Tests with amperometric sensors, depicted in Fig. 10.1-1, confirm that hydrogen partial pressures in the liquid phase are significantly higher than those in the gas phase.

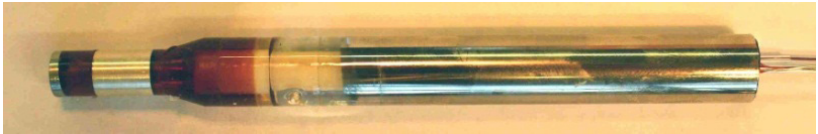

Figure 10.1-1: Amperometric hydrogen sensor (Source: KSI)

The measurement of the dissolved hydrogen is therefore an absolutely necessary component of a reliable early warning system for biogas plants. Due to insufficient long-term stability, the amperometric sensors have, however, proven to be not suitable for practical use. Biofilms that are formed by numerous microorganisms on the membrane and the solid surfaces have a negative impact on the sensors within a few days. For this reason, the particularly long-term stable measuring system depicted in Fig. 10.1-2 was developed which is based on the extraction of the dissolved hydrogen (and other gases) from the liquid biogas substrate.

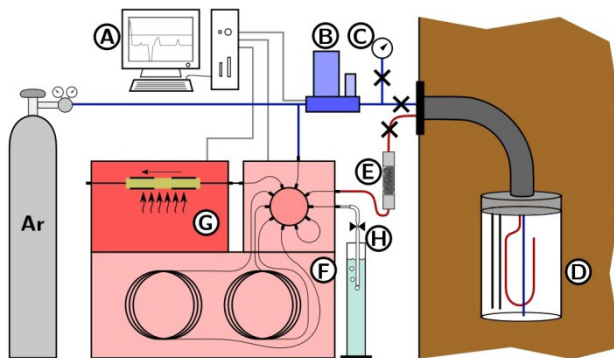

Figure 10.1-2: Measuring system for the determination of dissolved gases in biogas media: (A) control unit; (B) mass flow controller; (C) manometer; (D) extraction unit in biogas medium; (E) filter; (F) field gas chromatograph; (G) coulometric detector, and (H) back-pressure regulator (Source: KSI)

This measuring system consists of an extraction unit that is continuously flushed with an inert gas. Inside this extraction unit, the extraction is carried out via an open interface between the media to be measured and the carrier gas. The gas mixture extracted this way is cleaned, separated chromatographically, and detected coulometrically.

From the graphs of the hydrogen and oxygen dissolved in the biogas medium, depicted in Fig. 10.1-3, it is apparent that the functionality of the measuring system is guaranteed even in the case of prolonged use in a biogas plant.

The hydrogen concentrations in the extraction gas range between 1 and 2 vol.-ppm, with a noise amplitude of ~ 0.5 vol.-ppm. Selected measured values are in the range between 1.5 to 4 vol.-ppm above the aforementioned hydrogen base concentration. No correlation can be derived between the feedings of the digester and the increased hydrogen values found. However, there is a correlation between the feedings of solid dung and the increased occurrence of larger hydrogen spikes.

The partial pressure of dissolved hydrogen can be used not only as a measure for the current process stability, but also as an early warning indicator for developing instabilities, as shown in Fig. 10.1-4.

Both the dissolved hydrogen as well as the hydrogen in the biogas were measured in a biogas laboratory system over the course of two weeks, during which the microbiology was stressed out from a continuous increase of the organic loading rate. While the base concentration of hydrogen in the biogas is constant, independent of the organic loading rate, the dissolved hydrogen partial pressure increases with increasing organic loading rate. With additional investigations regarding the limits of the process stability, handling instructions can be derived so that operators receive a tool for secure plant management. Measuring the dissolved hydrogen makes sense particularly during the startup phase of new plants and for the monitoring of substrate change processes. For plants working stable at steady state conditions the measuring system can provide information on load optimisation.

Hydrogen in the biogas

With respect to the aforementioned problem regarding the measuring of the dissolved hydrogen in biogas media, hydrogen measurements, to date, are in practice carried out solely in the gas phase of biogas plants. Quite often, a hydrogen measurement is installed downstream of the desulphurisation of the biogas. In comparison to the measurement in the liquid phase, this approach is associated with the following disadvantages:

- Increased response times due to the large volumes in the headspace of the plants
- Undefined lowering of the hydrogen partial pressure in the biogas due to microbial activities in the headspace or in the desulphurisation and diffusion through sealing materials
- Lower partial pressures due to delayed mass transfer from liquid phase (PAUSS et al. 1990).

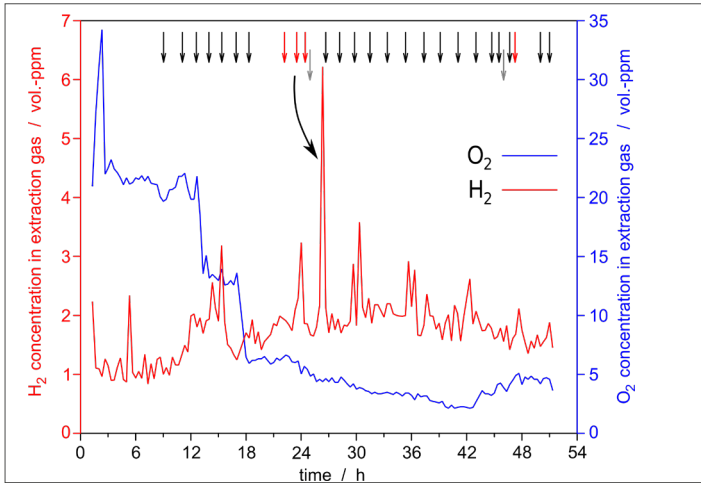

Figure 10.1-3: Online measurement of the dissolved hydrogen and the dissolved oxygen in a biogas plant, feeding times marked with arrows, red = solid cattle dung, black = maize silage, grey = cattle manure (Source: KSI)

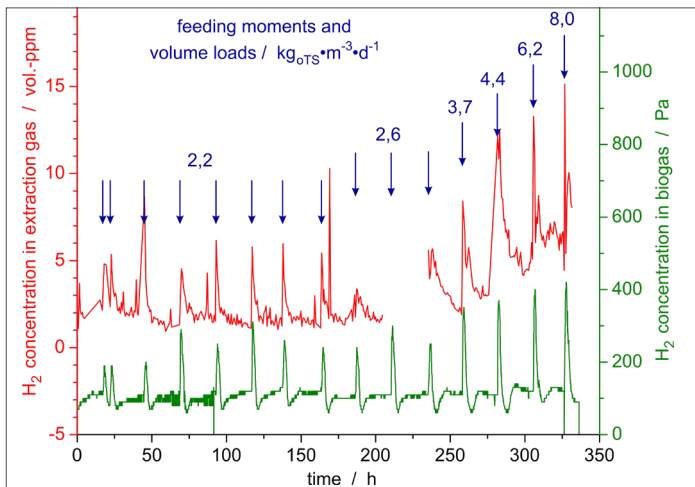

Figure 10.1-4: Online measurement of the dissolved hydrogen and the hydrogen in the biogas in a biogas laboratory system whose microbiology is being stressed increasingly by increasing the organic loading rate; feeding times indicated by arrows, feeding amounts specified as organic loading rate (Source: KSI)

The measurement of the H_2 partial pressures in the range of 1–1,000 Pa present in biogas is currently carried out usually with electrochemical sensors that are commercially available (e.g. City-Technology Ltd., www.citytech.com). When using these sensors, above all, their relatively high cross-sensitivity to H_2S has to be taken into consideration. Due to this sensitivity a prior removal of H_2S from the measuring gas is required. Heat conductivity sensors feature a high long-term stability but are often not sufficiently sensitive for the concentrations at hand. Other sensor principles such as FET sensors are in development and cannot be used long-term stable in biogas mixtures yet.

Conclusions

With the newly developed measuring system for long-term stable and selective dissolved gas analysis in biogenic media, a helpful tool for the optimisation of biogas processes was created. Successful tests in different biogas plants have confirmed that with its help hydrogen, oxygen and methane can be detected with high sensitivity, selectivity and long-term stability. The measuring rate of approximately 3–6 measured values per hour is sufficient for an early detection of disruptions in the microbial biogas production. The dissolved hydrogen is a key parameter that can be utilised as a guide value for the process stability and for the optimisation of the plant load.

10.2 *In-situ* investigation of multiple physico-chemical parameters in the liquid phase of digesters with mobile sensor devices

Anika Bockisch, Stefan Junne, Peter Neubauer, TU Berlin

	Mobile multi-parameter sensor device with miniaturised sensors for combined vertical and horizontal movement	Mobile multi-parameter sensor device with commercially available sensors for vertical movement
Field of application	<ul style="list-style-type: none"> • <i>In-situ</i> application in biogas processes was proven for up to 30 days; data transmission over a distance of 5 m via cable to a wireless transmission station; application through valves and guide bars either from the side or the top. 	<ul style="list-style-type: none"> • <i>In-situ</i> application in biogas processes and brewing processes was proven for up to 3 months; data transfer via cable over distances of up to 30 m; application from the top.
Advantages	<ul style="list-style-type: none"> • Six parameters can be measured simultaneously. • Sensor device and integrated cables are easy to handle due to the small size. • Lance-based systems combined to a rope are available for moving the device in both, horizontal and vertical direction, in retrofitted tanks. 	<p>After about 200 h of fermentation, the drift was 0–max. 4.4 % for the pH-value, 0.8–max. 2 % for the redox potential, and 0.3–max. 2 % for the DO value; no drift for conductivity measurements</p> <ul style="list-style-type: none"> • Modular construction, thus easy exchange of commercially available sensors is possible. • Data transfer via cables is feasible over at least 30 m due to the integrated pre-amplifier in the sensor head.
Disadvantages	<ul style="list-style-type: none"> • Drift in complex medium has to be considered to correct measurement values. • Wired data transfer feasible up to 5 m. 	<ul style="list-style-type: none"> • Long cables are not easy to handle, so far no coupling to wireless data transmission conducted.

Need for research	<ul style="list-style-type: none"> Increasing the measurement stability of the sensors is necessary for long-term use in complex media. Combination of vertical and horizontal movement requires retrofitting for application in a wide range of various digester designs. The integration of more than three sensors into the housing device would be beneficial. Development of sensors, which can be integrated into the sensor device would be advantageous, e.g. DO₂ for the biogas process and biofuel production (integrable sensors for optical density, viable biomass/capacity are already in development). Application studies in various biogas plants are required to identify the importance of gradients on the process performance and the relevance of the presented tool for process optimization.
Sample preparation	<ul style="list-style-type: none"> None, no samples needed
Special characteristics	<i>In-situ</i> , real-time, multi-parameter and locally flexible measurement of multiple parameters
Quality criteria	The measurement accuracy was determined by the maximum accuracy in standard solutions. The maximum drift within a time of up to 220 h in culture broth was determined by a series of experiments with regularly repeated measurements in (calibration) standard solutions.

Background

The power input in digesters is limited in large-scale for various reasons. Hence, mixing times increase at higher volumes, whereas heat and mass transfer rates decrease. This might lead to spatial gradient formation of different physical or chemical parameters, e. g. the pH-value, dissolved oxygen (DO) or carbon dioxide (DCO₂). Any sensor technology, which is located at one arbitrarily chosen spot in large-scale reactors, is not suitable to investigate heterogeneities in the liquid phase, e.g. to optimise stirring intensity in a biogas plant or to choose a suitable location of the sampling port to gain representative samples of the liquid phase.

In order to characterise gradient formation in the liquid phase, two locally flexible multiparameter sensor tools were developed for *in-situ* and *on-line* measurements. Both sensor tools were applied in biogas processes, which were operated with renewable biomass resources and manure under typical process conditions.

Monitoring devices and application

The mobile, multi-parameter sensor devices (Fig. 10.2-1) are applicable in various biogas digesters of different geometries and scales.

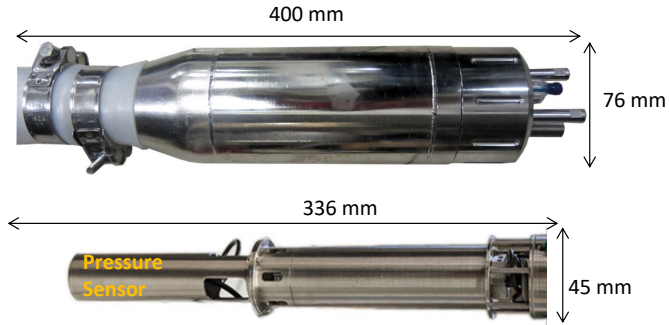

Figure 10.2-1: Multi-parameter sensor devices. Top: Larger device with commercially available sensors (Exner Process Equipment (EPE), Germany); Bottom: Smaller device with miniaturised sensors (developed by Kurt-Schwabe-Institut Meinsberg (KSI), Germany)

In case of the larger sensor device, three commercially available sensors for the measurement of the pH-value, redox potential, and conductivity or DO (including temperature sensors for each) were integrated into a stainless steel housing (Fig. 10.2-2). This was mounted on a steel rope and inserted from the top of a biogas digester with a concrete roof. The device was applied at different positions through various ports of the digester's concrete roof (research biogas plant of Univ. Hohenheim), which allowed the multiple application in different heights (vertical position) and distances from the vessel wall (horizontal position). For the reduction of weight and size, six tailored microsensors for the pH-value, redox potential, temperature, pressure, DO and DCO_2 concentration from the Kurt-Schwabe-Institut (KSI) Meinsberg, were integrated into a smaller steel housing (Fig. 10.2-2). The device was inserted into a carbon-fiber lance and connected to a rope-based system for *in-situ* monitoring in radial and axial direction at a typical biogas digester with a concrete wall (Fig. 10.2-3). The lance had a length of 6 m. It was movable in horizontal direction, while the release of the rope allowed a vertical movement.

Data transmission to the recording computer was wired in case of the larger sensor device. The data transmission for the microsensors was wired to the outer vessel wall, and wireless from there onwards.

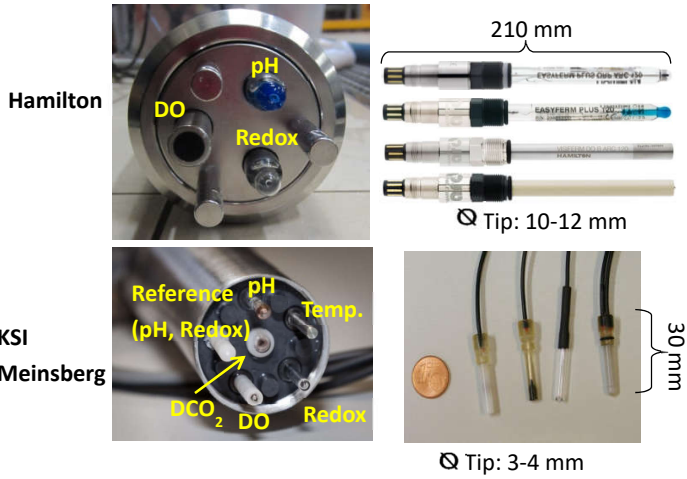

Figure 10.2-2: Applied sensors for measurements: Top: ARC sensors (Hamilton Messtechnik, Germany); Bottom: Miniaturised selfmade sensors (Kurt-Schwabe-Institut Meinsberg (KSI), Germany), (SACHSE et. al 2015)

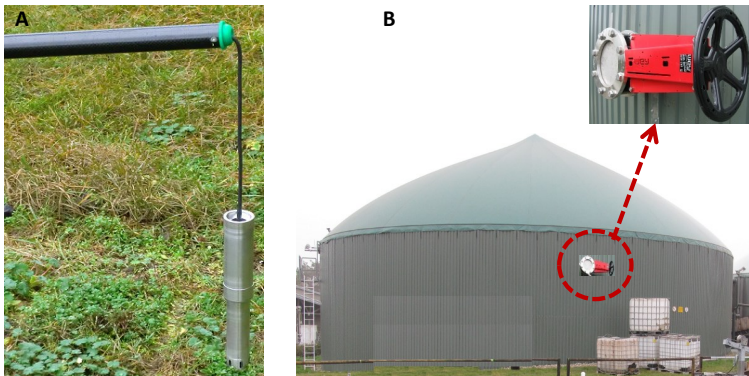

Figure 10.2-3: Application of the miniaturised sensor device in a digester with a flexible roof (B). Horizontal and vertical access is realized by a gate valve (B), a lance and a flexible rope (A)

Measurement principles

The measurement principles of the sensors are summarised in Tab. 10.2-1 for each applied parameter.

Table 10.2-1: Measurement principles of sensors

Parameter	Miniaturised sensors	Commercially available sensors
Conductivity	–	4-pole contact sensor (resistance)
pH-value	Potentiometric (ext. reference electrode)	Potentiometric (integrated reference electrode)
Redox potential	Potentiometric (ext. reference electrode)	Potentiometric (integrated reference electrode)
DO conc.	Amperometric (3-electrode system)	Oxygen dependent luminescence quenching
DCO ₂ conc.	Potentiometric	Not applicable
Pressure	Piezo-resistive (electrical resistance)	Not applicable

Calibration

The sensors were calibrated before each measurement campaign with standard solutions (Tab. 10.2-2).

Table 10.2-2: Calibration solutions

Parameter	Solution
Conductivity	Conductivity standard solutions of 12.880 mS cm ⁻¹ and 100 mS cm ⁻¹
pH-value	pH = 4.1, pH = 7.0
Redox potential	Redox standards of 124 mV and 250 mV
DO conc.	Air, nitrogen sparging
DO ₂ conc.	Sterile wort solution with a defined CO ₂ content

Measurements - conditions and results

The long-term application of miniaturised sensors with a small membrane diameter and electrolyte volume is challenging in complex media due to the risk of clogging or toxification of the electrolyte by chemical compounds that might negatively affect the measurement stability and sensor drift. However, the sensor performance was sufficient to monitor process parameters during a period of up to 30 days in the biogas process. The commercially available sensors showed a drift below 5% during an application period of several months. Data processing was carried out with MATLAB (The MathWorks, Inc.).

In Fig. 10.2-4 and 10.2-5, results of the measurement with the sensors in a 920 m³ biogas digester at different heights of one port (red circle) are displayed. After the movement of the sensor devices to another position, the sensor response and stabilisation time of the liquid have to be considered. Thus, only data recorded a few minutes (1–2) after the movement were considered.

Spatial gradients of up to 15 mV for the redox potential were measured with the miniaturised sensor device at different heights (Fig. 10.2-4) (KIELHORN et. al 2015). During monitoring with the larger sensor device in the same digester over several months, conductivity gradients of up to 30 mS cm⁻¹ were measured at certain time points, whereas for the redox potential, the pH-value, and the temperature, no spatial, but time-dependent gradients were determined (Fig. 5). Although these gradients are not of great magnitude, they might have an impact on the cellular and therefore process performance if they occur suddenly and show oscillating behaviour. The monitored parameters changed in case of feeding, especially close to the location of the feedstock input and close to the liquid surface. Any correlation between feedstock addition and conversion for acid and biogas production is currently investigated in more detail, especially in case of the redox potential and the conductivity. Both parameters developed differently in response to the amount of feedstock, the composition of it and the intensity of power input by stirring. As it can be seen in Fig. 10.2-4, and for conductivity in Fig. 10.2-5, the position (height) of the sensor mattered for the sensitivity of the respective parameter to responses to time-dependent process changes.

It can be assumed that this technology is suitable to identify conditions, at which sensors have to be located for monitoring the liquid phase in order to detect changes in the process early and eventually long before changes in the gas phase composition can be detected. This would allow to achieve higher process robustness, e.g. at a dynamic feedstock load scenarios.

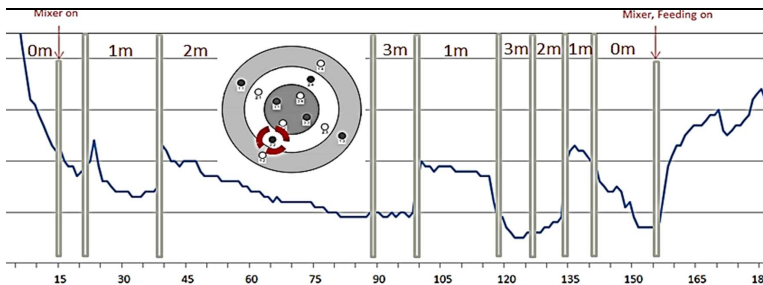

Figure 10.2-4: Investigation of redox potential gradients with the miniaturised sensor device in a 920 m³ biogas digester (KIELHORN et. al 2015)

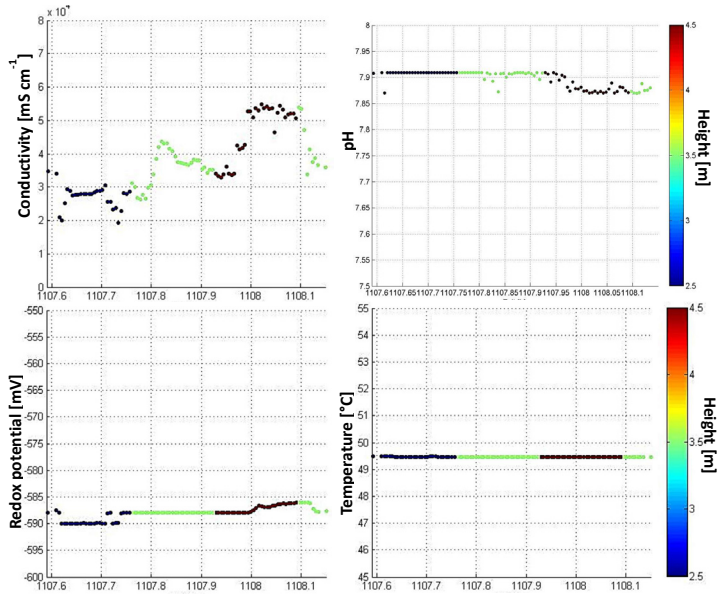

Figure 10.2-5: Investigation of conductivity, redox potential, pH-value, and temperature gradients with commercial sensors in a 920 m³ biogas digester (KIELHORN et. al. 2015).

10.3 Determination of methane potential of organic biomass using Automatic Methane Potential Test System (AMPTS II)

Jing Liu, Mihaela Nistor, Sten Strömberg, Bioprocess Control Sweden AB

Status	<p>The BMP test carried out with AMPTS II, to determine the biochemical methane potential and dynamic degradation profile of any biomass substrate, is widely used by academic scientists, public and private laboratories, energy producers, organic waste handlers, wastewater treatment plants, etc.</p> <p>As an automated experimental tool for anaerobic batch fermentation, AMPTS II can fulfil the requirements of test apparatus stated by various protocols, guidelines and standards for BMP and anaerobic biodegradability analyses.</p>
Standard	<p>German Standard VDI 4630: Fermentation of organic materials – characterisation of the substrate, sampling, collection of material data, fermentation tests (2016) is considered to be the closest associated standard for AMPTS II. However, the instrument does support other relevant ISO and national standards.</p>
Area of application	<p>The AMPTS II can be used for conducting anaerobic biodegradability, methane potential and specific methanogenic activity (SMA), residual gas potential (RGP) and substrate inhibition assay. This allows users not only to screen and choose the optimal substrate or mixture producing the highest amount of biomethane, but also to select between different pre-treatment alternatives and evaluate the need for additives used for AD processes.</p>
Limitations	<p>The widely used AMPTS II and its lighter version, AMPTS II Light, are designed for monitoring the accumulated volume of biomethane and not recommended for measuring total biogas. Furthermore, the agitation system of AMPTS II may not be sufficient for batch fermentation tests of biomass with very high solid content under the dry or solid-state fermentation configuration</p>
Advantage	<p>The AMPTS II provides the following advantages over conventional BMP tests/methods:</p> <ul style="list-style-type: none"> ● an automated analytical system, which reduces the work-load and the risk of minimising errors caused by human operation ● an user-friendly interface for experiment set-up, real-time data display and analysis overview ● Real-time data logging of accumulated bio-methane volume and flow rate ● Real-time gas flow and volume normalisation to STP ● The possibility of multiplexing, allowing for simultaneous batch analysis at different start-up times

Advantage	<ul style="list-style-type: none"> ● High-quality data for extracting process kinetic information ● Different gas measuring resolutions are available ● It's a standalone instrument with embedded data acquisition and web server for remote access ● User friendly operation with low and easy maintenance
Need for research	The current limitations of the equipment are expected to be overcome in the next generation of AMPTS, where its agitation system will be redesigned for both wet and dry fermentation tests. The new instrument model will allow analysing biomethane, total biogas and any high water-soluble gas, such as carbon dioxide, with precision and accuracy.
Additionally for methods of batch tests	
Inoculum	The inoculum should be collected from an active anaerobic digester that is digesting complex organic matter to ensure a diverse microbial community able to digest a large variety of substrates.
Inoculum preparation	The inoculum should be homogeneous and large materials (e.g. stones, plastics, wood) should be removed. Pre-incubation in order to reduce the residual biodegradable organic materials is recommended for inoculum collected from agricultural plants (i.e. VSFM > 4%).
Sample quantities	To obtain highly accurate data, the experiment should be set-up correctly: a good amount of inoculum-substrate mixture (e.g. 400 g in 500 mL bottles), low headspace volume, low inoculum-to-substrate ratio in terms of VS (in the range 2 to 4) in order to generate a high volume of gas at a high flow rate during an AD process.
Special characteristics	Continuous mixing for high viscosity or fiber-rich samples, activation of "eliminate overestimation" function when an inert gas (e.g. N ₂) is used to flush the system prior to initiating the experiment and biomethane is measured.
Criteria applied for BMP test validation	<p>The following points must be fulfilled in order to validate the BMP test results:</p> <ul style="list-style-type: none"> ● The number of replicates should be at least three for all the tests. ● When investigating the BMP of a target substrate, blank assays (background methane production from the inoculum) and positive controls (e.g., microcrystalline cellulose, starch, gelatine, tributyrine) must be carried out. ● The tests should be terminated when daily biomethane production during three consecutive days is less than 1% of the total accumulated volume of methane. ● The RSD of substrates and positive control should be less than 10%, ● The BMP of positive control substrate should be between 85% and 100% of the theoretical BMP value (HOLLIGER et al. 2016).

The conventional anaerobic biodegradability and methane potential analyses are anaerobic batch fermentation methods (also called Biochemical Methane Potential - BMP tests) which are subject to relatively large variations in analytical results, not only due to the heterogeneous nature of bio-wastes and bacteria culture used, but also due to the variety of the equipment and non-unified test protocols.

Although a number of different standard assays and protocols have been proposed over the last 20 years to standardise the BMP test procedure, they often differ in the experimental setup, gas measuring techniques, and are adapted to the specific researcher's purpose. Consequently, it is often difficult to evaluate results from inter-laboratory BMP tests even though similar test protocols are followed. Furthermore, many conventional methods for methane potential analysis are very time consuming and labour-intensive procedures. The quality of analysis often relies on the laboratory skills and experience of an individual who performs the assay. As a result, the conventional methods often lead to large random and systematic errors due to the poor-quality control of the measurements and manual operations.

This book section presents a proposed methodology for BMP assay using the Automatic Methane Potential Test System (AMPTS II), a fully automated experimental platform for conducting various anaerobic batch fermentation assays. The instrument has been widely used as the preferred tool by scientists and process engineers around the world for BMP, specific methanogenic activity (SMA), test inhibition and residual gas potential (RGP) analyses. The instrument includes several built-in functions which ensure reliable gas measurements since interference factors for gas volume and flow rate measurements, such as ambient temperature and pressure, water vapour content and initial gas composition of the reactor headspace, are well controlled. Therefore, the system allows for standardisation of measurement procedures, data interpretation and reports. This allows results obtained in different laboratories to be easily compared.

Equipment description and chemicals

AMPTS II consists of three major parts (Fig. 10.3-1):

- A temperature-controlled water bath containing 15 reactors of 500 mL, each equipped with a motor driven agitator that can be run in either continuous or intermittent mode, with speed and rotation direction control;
- A CO₂-absorption unit with an alkaline solution that absorbs the carbon dioxide and hydrogen sulphide produced during the anaerobic digestion;
- A gas measurement unit consisting of 15 parallel operating cells, where the gas is measured through liquid displacement and the force of buoyancy. For each measurement point, the time, temperature and pressure are registered and used to normalise the measured gas volume to standard conditions (STP).

Other than the investigated samples (i.e. substrates) and anaerobic sludge (i.e. inoculum), the following materials are also needed for the operation of AMPTS II:

- sodium hydroxide (reagent grade 97 %, pellets) used for the preparation of 3 M alkaline solution for CO₂ fixation;
- deionised water for the thermostatic water bath and gas measurement unit;
- 0.4 % thymolphthalein pH indicator solution prepared by dissolving the dye powder (2', 2'' - Dimethyl-5, 5'' - di-iso-propylphenolphthalein, dye content 95 %, in a mixture containing 10 % water and 90 % ethanol);
- N₂ or N₂/CO₂ gas used as flush gas to obtain anaerobic conditions in the reactor headspace during the sample preparation phase;
- microcrystalline cellulose used as positive standard substrate for validating BMP test results (i.e. expected BMP for cellulose should be between 352 and 414 L (STP) CH₄ per kg VS added) (HOLLIGER et al. 2016);
- A computer is also needed to access the instrument's embedded software. All interactions with the AMPTS II software are conducted through a web browser (preferably Google Chrome), either through connection directly with a ethernet cable or via a local network.

Execution method

The inoculum, positive control substrate and all samples are initially characterised in terms of TS, VS, and moisture content. VS content provides an estimation of the organic matter in the sample and it is expressed either as the percent of the TS or as the percent of the initial amount of sample also called fresh matter (i.e. VSFM). The second case is applied in Bioprocess Control's protocol, when the VS is calculated as the ratio between the difference in the amount of sample after drying (105 °C, 20 h) and burning (550 °C, 2 h), and the initial amount of sample.



Figure 10.3-1: The Automatic Methane Potential Test System (AMPTS II) (Bioprocess Control Sweden AB)

For statistical significance, triplicates of all reactors (500 mL) are used: 3 reactors as blanks (i.e. reactors containing only inoculum), 3 reactors each with inoculum and the investigated sample(s) and 3 reactors for control substrate (i.e. reactors containing inoculum and cellulose). The inoculum-to-substrate ratio in terms of VS is usually set as 2 to 1 and the assay is performed at mesophilic or thermophilic conditions. An active volume of 400 mL is recommended to be used in all tests and gentle mechanical agitation is performed either intermittently or continuously to ensure good mass transfer and adequate release of gas from the fermentation liquid. Before starting a BMP test, each reactor headspace is flushed for approximately one minute with an inert gas to achieve anaerobic conditions. The test is initiated by starting the agitation and heating of the incubation unit and finally, initiating the data registration for each cell in the AMPTS II software. For more accurate results, it is recommended to manually open each cell and release any trapped gas before starting the test. If the blue colour of the alkaline solutions in the CO₂-absorption units turns transparent, it means that it is saturated with CO₂ and should be replaced with fresh solution. At the end of the process, a report which presents the normalised methane flow rate and cumulative volume is generated from AMPTS II. The BMP value (STP) is calculated by subtracting the gas production of the inoculum from the gas production of the sample and dividing it by the amount of VS added in the reactor.

Data analysis

The AMPTS II web-based software application has been specially designed for carrying out BMP and other related fermentation tests. This application, which is easy to understand and navigate, allows users to set-up an experiment, monitor its progress and download results with little effort. The graph feature of the AMPTS II software allows users to control and follow up their experiment in real-time from any location with an Internet connection. The users can easily monitor the accumulated volume of gas and current flow rate of each bioreactor in real-time, by selecting and viewing only the ones they wish to see (Fig. 10.3-2). All values displayed in the graphs are normalised to STP, and the values are adjusted for possible overestimations if the composition of gas used to flush the system prior to initiating the experiment is different from the expected biogas composition.

The report generated by the AMPTS II equipment can be opened in any spreadsheet software (e.g., Microsoft Excel) and contains all the information needed to determine BMP:

- i) accumulated biomethane volume from the sample bottle(s);
- ii) accumulated biomethane volume from the blank bottle(s);
- iii) VS amount of substrate in sample bottle(s);
- iv) VS amount of inoculum in sample bottle(s); and
- v) VS amount of inoculum in blank bottle(s).

The BMP of the substrate and the positive control are determined by subtracting the methane production of blanks and the gross methane production of the substrate/positive control assays. For validating the BMP test results, the compulsory elements presented in HOLLIGER et al. 2016 must be fulfilled.

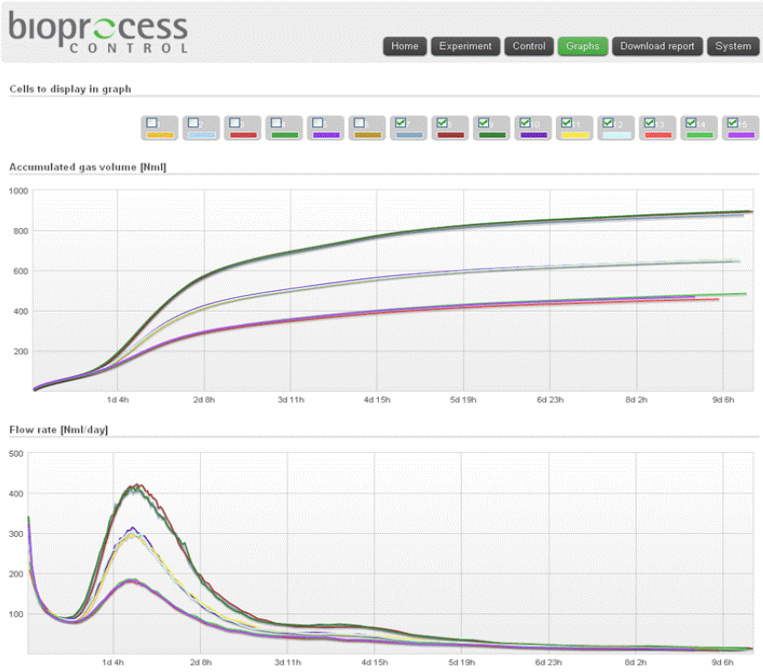

Figure 10.3-2: Typical curves obtained for the accumulated volume of biomethane (up) and flow rate of the gas produced (down) using AMPTS for triplicate positive control substrate (i.e., cellulose) at different inoculum to substrate ratios (2, 4, 6)

10.4 Determination of carbon compounds (methane, carbon monoxide and carbon dioxide in biogas and biomethane using non-dispersive infrared spectrometry (NDIR))

Michael Landa, Christian Etzkorn, Ernst Murnleitner, Awite Bioenergie GmbH

Status	Commercially available
Standard	Gas-analytical measurement methods
Area of application	Biogas and biomethane quality assessment
Disadvantage	<ul style="list-style-type: none"> not described in international technical standards lower selectivity when compared to gas chromatography
Advantage	<ul style="list-style-type: none"> cost-effective in comparison with gas chromatography suitable for online measurement with low response time to concentration variations significant reduced cross-sensitivity of the methane measurement to other hydrocarbons in comparison with conventional NDIR-methane-measurement, in which the measurement is carried out at different wavelengths compensation of interferences due to the gas matrix in comparison with conventional NDIR-methane-measurement without compensation
Need for research	<ul style="list-style-type: none"> implementation of further measurement at additional wavelengths at which only higher-valence hydrocarbons have absorption peaks to determine their concentration selectively

The NDIR spectrometry is a robust and cost-effective method to determine the concentration of gas components such as methane and carbon dioxide in biogas and biomethane - and even carbon monoxide in certain synthesis gases. In contrast to gas chromatography NDIR offers a substantially quicker measurement result and is therefore very suitable for online measurement. In the presented method alternative wavelengths and internal compensations of cross influences are utilised to achieve significant improvements for the described applications.

Sample preparation

In order to analyse the composition of biogas with a NDIR sensor, it is necessary to implement a gas conditioning consisting of different stages. Due to the broad possible water vapour concentration range, gas drying is needed in order to achieve a low and defined humidity of the gas. Furthermore, a particulate filter is needed to prevent deposits of particulates on the optics of the sensor which would lead to a drift of the measurement signals. For a precise and stable measurement, it is also necessary to avoid gas turbulences and pulses in the measurement chamber.

Calibration

Each individual NDIR sensor exhibits a different measurement behaviour and different progression of measurement values. Therefore, it is necessary to calibrate the sensor with defined gas mixtures. In conventional NDIR sensors it is important to take the whole gas matrix in the gas mixtures into account, not only the component to be measured and calibrated, as conventional NDIR sensors do not compensate effects resulting from different gas matrices.

Execution Method

NDIR measurement is based on the wavelength-dependent infrared absorption of a gas sample. The sensor consists of the following components:

- an infrared emitter, in the simplest case a light bulb, in applications with higher requirements regarding measurement accuracy a specially designed microelectromechanical radiation source
- a control and monitoring unit for the infrared emitter
- an infrared detector with one or multiple independent channels with bandpass IR-filters
- a measurement chamber incorporating the aforementioned components
- a computing unit to evaluate the signals of the other components and implement calculations like calibration and linearisation algorithms
- a pressure sensor to compensate the influence of the gas pressure on the measurement signals

O obeying the LAMBERT-BEER law, the wavelength-dependent infrared radiation absorption is proportional to the concentration of the individual gas components in the sample. To measure the different carbon compounds of interest, bandpass IR-filters are applied to examine specific wavelengths which provide the maximum absorbance and minimum interference for the individual gas components. The absorption spectrum of carbon dioxide shows suitable peaks at about 4.3 μm and 15 μm , for carbon monoxide a double-peak at around 4.65 μm and for methane peaks at about 3.4 μm and 7.7 μm . To obtain a measurement signal with high specificity, it is of crucial importance to choose bandpass IR-filters so that no other component absorbs IR radiation in the bandpass sector.

Cross sensitivities

As shown in Fig. 10.4-1, none of the hydrocarbons absorbs infrared radiation at the peak of carbon dioxide. There are no cross-sensitivity issues at this wavelength, the spectrum of carbon monoxide (not illustrated) shows an overlap with the spectrum of carbon dioxide, but this is not of relevance for biogas applications as carbon monoxide is usually not present in biogas.

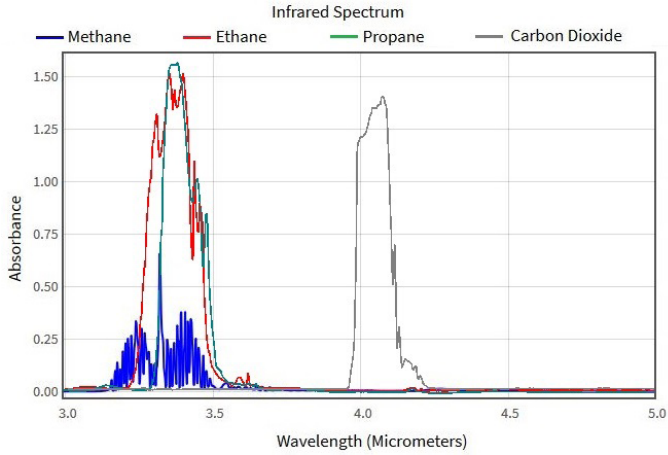

Figure 10.4-1: Infrared absorption spectra of methane, ethane, propane and carbon dioxide from 3.0 to 5.0 μm

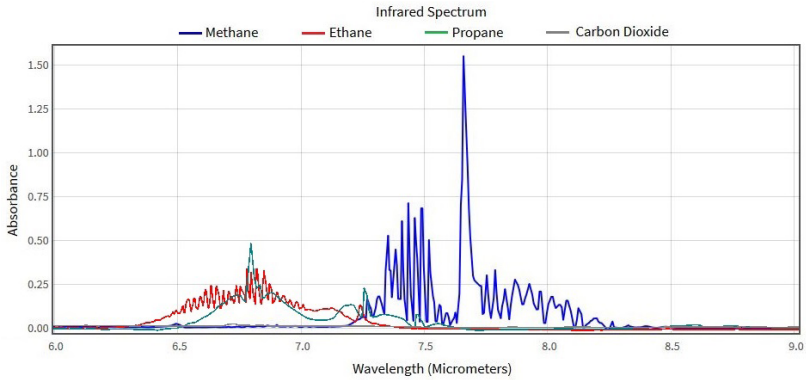

Figure 10.4-2: Infrared absorption spectra of methane, ethane, propane and carbon dioxide from 6.0 to 9.0 μm

Usual NDIR methane-sensors measure the infrared radiation absorption at about $3.4\ \mu\text{m}$, which leads to high cross sensitivities to higher-valence hydrocarbons as shown in Fig. 10.4-1. For a high specificity, the infrared range shown in Fig. 10.4-2 has to be utilised. The cross sensitivities in the range of $3.4\ \mu\text{m}$ are highly nonlinear. In a methane sensor measuring at about $3.4\ \mu\text{m}$, designed and calibrated for 0 to 100 % ($\text{m}^3\ \text{m}^{-3}$) methane, the following gas mixtures lead to the following measurement signals:

- 1% ($\text{m}^3\ \text{m}^{-3}$) ethane and 99% ($\text{m}^3\ \text{m}^{-3}$) nitrogen: measurement signal equal to 10% ($\text{m}^3\ \text{m}^{-3}$) methane
- 1% ($\text{m}^3\ \text{m}^{-3}$) ethane, 50% ($\text{m}^3\ \text{m}^{-3}$) methane and 49% ($\text{m}^3\ \text{m}^{-3}$) nitrogen: measurement signal of about 90% ($\text{m}^3\ \text{m}^{-3}$)
- 1% ($\text{m}^3\ \text{m}^{-3}$) ethane, 90% ($\text{m}^3\ \text{m}^{-3}$) methane and 9% ($\text{m}^3\ \text{m}^{-3}$) nitrogen: measurement signal significantly above 100% ($\text{m}^3\ \text{m}^{-3}$).

The cross-sensitivities to propane and butane are similar. With a proper selection of the bandpass filter for the methane measurement at around $7.7\ \mu\text{m}$, this cross sensitivity can be reduced substantially. From the aforementioned gas mixtures only the mixture of 1% ($\text{m}^3\ \text{m}^{-3}$) ethane, 90% ($\text{m}^3\ \text{m}^{-3}$) methane and 9% ($\text{m}^3\ \text{m}^{-3}$) nitrogen leads to a measurable deviation of the measurement signal, which is 0.1% ($\text{m}^3\ \text{m}^{-3}$) giving 90.1% ($\text{m}^3\ \text{m}^{-3}$) instead of 90% ($\text{m}^3\ \text{m}^{-3}$) methane.

In biomethane applications, upgraded biogas may be mixed with higher-valence hydrocarbons, such as butane, propane or ethane in order to achieve the required calorific value for injection into the natural gas grid. Due to the practically relevant ranges of additions of higher-valence hydrocarbons in these applications, the cross sensitivities are low enough to measure methane with very high precision. A possibility for further enhancement of the measurement principle would be to implement the measurement of the whole range of $6.5\ \mu\text{m}$ to $7.5\ \mu\text{m}$ to determine the concentrations of other present hydrocarbons. Due to their infrared absorption spectra and their concentration, no further component of biogas or biomethane leads to a measurable cross sensitivity.

Gas matrix

The presence of nitrogen, oxygen and more than one analyte (e.g. methane and carbon dioxide) in biogas leads to interferences due to IR-band broadening effects which have to be compensated with special algorithms in order to obtain precise measurement signals. As the possible nitrogen concentrations in biogas are higher than possible oxygen concentrations, the effect of nitrogen is discussed below.

The infrared absorption of the analyte gas varies significantly depending on different background gases as shown in Fig. 10.4-3 to 10.4-5. Measurement values can deviate by 10% ($\text{m}^3\ \text{m}^{-3}$) from the actual value. With a sensor capable of measuring both methane and carbon dioxide and with the implementation of according algorithms, it is possible to compensate this effect completely. This leads to the advantage of higher measurement accuracy in comparison to the NDIR measurement without this compensation. Furthermore, the calibration procedure is simplified, as the gas matrix is of lower importance due to this

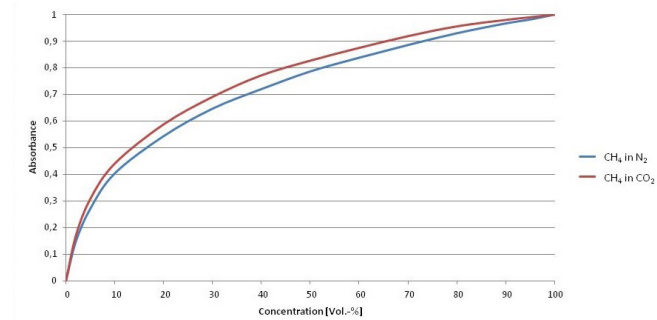

Figure 10.4-3: Concentration-dependent infrared absorption of methane at 3.4 μm with background gas nitrogen or carbon dioxide

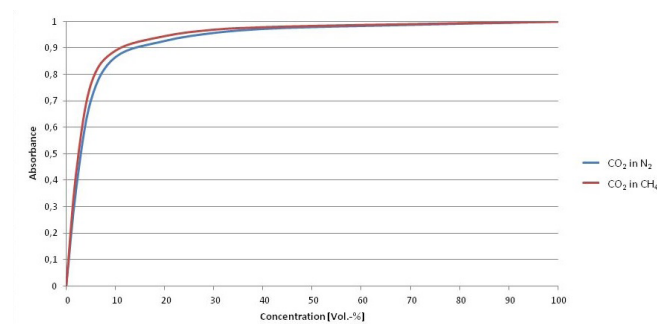

Figure 10.4-4: Concentration-dependent infrared absorption of carbon dioxide at 4.3 μm with background gas nitrogen or methane

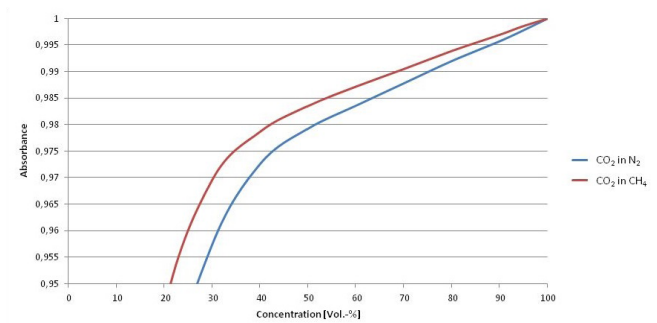

Figure 10.4-5: Concentration-dependent infrared absorption of carbon dioxide at 4.3 μm with background gas nitrogen or methane (high range)

compensation. With these improvements, the NDIR measurement is a suitable substitution for gas chromatography, which has further inherent disadvantages as no online-measurement capability due to the long measurement duration, higher costs, higher maintenance and calibration requirements and corrosion problems.

Conclusion

Nowadays, the technology of NDIR spectrometry is widespread on the market, with many distributors worldwide. In Germany, it is not allowed to use NDIR measurement to control biomethane injection in the gas grid due to the lack of available equipment certified as calibratable (“eichfähig”). Nevertheless, the technology can be cost-effective and reliable compared to the usual application of gas chromatography. In most biomethane plants, NDIR analysers are already installed in addition to gas chromatographers, especially to continuously monitor the upgrade process and to determine the composition of the raw biogas. Especially for emerging biomethane markets, where the regulatory framework is not yet consolidated and/or certificates are not required, the use of this more cost-effective technology would allow cost reduction and therefore economic advantages. A further step in this direction is the publication of international standards that describe the application of NDIR spectrometry.

10.5 Substrate suitability assessment for anaerobic dry digestion processes - Method to determine substrate material permeability under compaction

Harald Wedwitschka, Daniela Gallegos, Jan Liebetrau, DBFZ; Earl Jenson, InnoTech Alberta

Status	In-house DBFZ method based on soil characterisation methods with adaptations to biomass samples under development/validation.
Standard	Adapted from DIN 18130 (DIN 18130-1998)
Area of application	Substrate characterisation and dry batch anaerobic digestion in mesophilic and thermophilic operation
Limitations of the method	Coarse substrate materials with particle size above 15 cm
Advantage	Fast method to determine the permeability of substrate materials with the opportunity to simulate different substrate heap heights in the anaerobic dry digestion process.
Need of research	The correlation of the percolation regime and material permeability and digestion efficiency is a topic of ongoing research.

The dry anaerobic batch digestion process is most appropriate for treatment of stackable (non-free-flowing) dry waste materials. Generally, the raw material is loaded into a dry digester bunker and after 20 to 30 days of substrate retention time in the bunker, the digested feedstock is replaced with another substrate load. During digestion, the feedstock material is sprinkled with process water or percolate, which helps to start the microbial biogas production and wets the process materials and supplies nutrients during digestion. However, the substrate needs to be and stay permeable during operation of the process in order to ensure the transportation of nutrients and intermediates during the digestion process. In particular, dry anaerobic batch digestion is highly dependent on the suitability of the material for the application (SHEWANI 2015, OLIVER 2007). The physicochemical properties of the material become significant because it must have a porous, permeable structure that permits suitable percolation (AHN 2008).

The material characterisation method was developed to determine the feedstock suitability for batch dry digestion with regards to permeability and material structural integrity (resistance to compaction) during digestion. This includes the behaviour of the substrate during the treatment process. With the help of the method, it is possible to measure and define the substrate mixture permeability. Material permeability can be increased by mixing substrates with low permeability such as wet organic waste with highly permeable substrates such as dry gardening waste. The addition of structure materials to materials with low permeability leads to an increase of the structural integrity and material permeability (see Fig. 10.5-1).

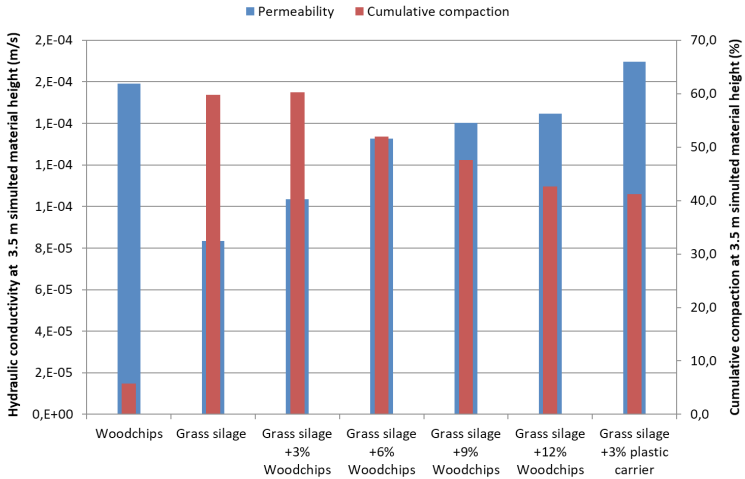

Figure 10.5-1: Permeability and Cumulative Compaction of different sample materials

The measurement of material permeability under compaction and further material characterisation methods that can be used for the substrate suitability assessment for dry batch anaerobic digestion are described in (WEDWITSCHKA et. al. 2016).

Devices

- oedometer with filter inlay and overflow (minimum suggested diameter of 25 m)
- compression plate connected to compression device
- water reservoir with overflow providing a constant hydraulic head pressure to the oedometer
- platform- or floor scale
- water barrel
- stop watch

Execution of the test

An oedometer is used to determine the hydraulic conductivity of the sample material under material compaction by applying a defined force on the top of the sample, which simulates the compaction that occurs in a full-scale environment with several meters of material height. The sample material is placed in an oedometer and compressive force is applied by a perforated plate. The compression plate is connected to an air piston as seen in Fig. 10.5-2 that can supply adjustable constant force. The compressive force of the perforated plate can be varied by the air pressure applied to the piston and can be measured with a scale at different air pressure settings. The measured compressive force is used to

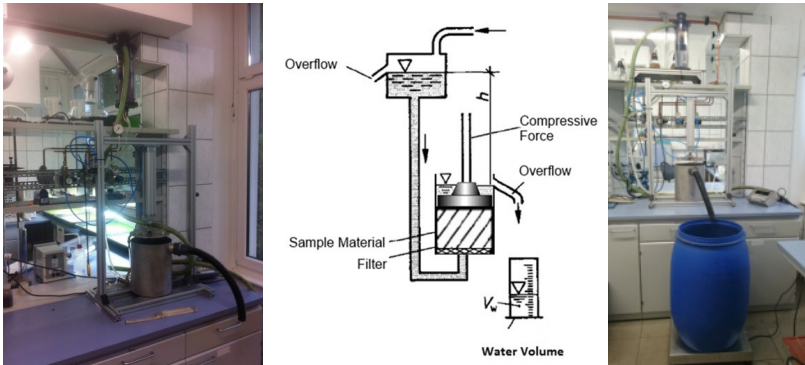

Figure 10.5-2: Test apparatus for permeability measurement

calculated the simulated material volume respectively high which results in an equivalent weight. The wet material density and oedometer area are used for the volume calculation. The hydraulic conductivity and the compressibility of the sample material can be determined at loose compaction and low, medium, and high compression equivalent to different material heights encountered in full-scale dry fermentation processes.

The oedometer device has a percolate influent port at the base and an effluent port near the top. A constant hydraulic head pressure is applied to the oedometer and the water flow/hydraulic conductivity is measured with a scale by weighing the amount of percolate (or water) that passes through the device (discharged) per unit of time. After loosely filling the oedometer with sample material, the water flow is started by opening the valve at the entrance to the oedometer. The water flows under constant pressure that is dependent on the hydrostatic height (h). The effluent is collected and the quantity per unit of time is documented. The waterflow through the sample material bed is dependent on the pore space of the material. Biomass samples loaded loose (with no compaction) show similar permeability characteristics. However, due to material compaction the pore space of materials with low structural integrity is reduced (see Fig. 10.5-3), which reduces hydraulic conductivity and can result in negative effects on the process performance. Measurements with different biomass samples showed decreasing material hydraulic conductivity at deeper substrate layers. This effect can cause digester flooding, channel building and increased percolation at digester walls and the risk of dead zones in middle and bottom of the digester.

Calculation of the permeability coefficient and material compactibility

In the first step it is necessary to determine the flow rate (Q) of the sample, which is calculated from the volume (V_w) of water passing through the sample material per unit of time (t).

$$Q = \frac{V_w}{t}$$

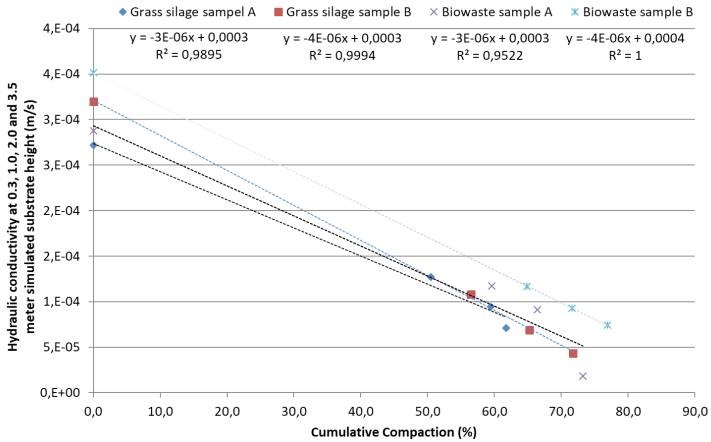

Figure 10.5-3: Permeability and Cumulative Compaction of different sample materials

The hydraulic conductivity (K) describes the ease with which the percolate can move through the pore spaces of the sample material. It is calculated by the quotient of the flow rate (Q) multiplied with the material sample height (l) divided by the material surface area in the oedometer (A) multiplied with the hydrostatic height (h).

$$K = \frac{Q * l}{A * h}$$

141

Compressive force is applied to the top of the substrate to simulate typical substrate heights found in full scale use. Depending on the air piston used the compressive force at different air pressure settings is varying and can be measured with a scale. The measured weight force is set into relation with the weight of the sample material volume at different material height.

The simulated material heap height (h_s) is calculated with the defined force applied by the perforated plate connected to the air piston and the oedometer diameter (d^2). The density of the water saturated sample (ρ) and the mass (m) of the sample material describe the simulated material volume. The cumulative compaction is determined by dividing the material height before and after compaction.

$$h_s = \frac{4m}{\pi d^2 \rho}$$

142

Table of tables

47	Table 3.1-1: Sampling documentation sheet: A) Sampling of cattle manure
48	B) Sampling of swine manure
54	Table 3.3-1: Bandwidth of the uncorrected total solids as well as the sum of the potentially volatile fermentation acids and alcohols (WEISSBACH & STRUBELT 2008a, 2008b, 2008c)
66	Table 4.1-1: The calibration utilised
67	Table 4.1-2: Description of the gas chromatograph (Agilent 7980A)
68	Table 4.1-3: Description of the headspace sample injector (PerkinElmer Turbo Matrix 110)
70	Table 4.2-1: Separation parameters in ion chromatography
71	Table 4.2-2: Separation parameters in high-pressure liquid chromatography (HPLC)
75	Table 4.4-1: List of components
78	Table 4.4-2: The calibration utilised
79	Table 4.4-3: HPLC settings (Shimadzu)
82	Table 4.5-1: Overview of the parameters for HPLC
84	Table 4.5-2: Overview of substances with retention time, calibration range, LOD, LOQ, and detector
97	Table 4.9-1: Programme of the extraction unit
99	Table 4.10-1: Method for the determination of crude fibre
100	Table 4.10-2: Method for the determination of ADF
103	Table 4.11-1: Method for the determination of ADF
106	Table 4.12-1: Method for the determination of NDF
123	Table 5.3-1: Retention time, Target ion and Qualifier ion of siloxanes
126	Table 5.3-2: Composition of specifically constructed first test gas cylinder (CH ₄)
127	Table 5.3-3: Composition of specifically constructed second test gas cylinder (N ₂)
128	Table 5.3-4: Concentration of siloxanes in the first and second in series connected tube
143	Table 5.5-1: Measurement methods utilised
146	Table 5.5-2: Comparison of the GWP values for a period of 100 years in accordance with the Fifth Assessment Report (AR5), Fourth Assessment Report (AR4), Third Assessment Report (TAR) and Second Assessment Report (SAR) of the Intergovernmental Panel on Climate Change (IPCC)
164	Table 5.8-1: Typical measuring conditions GC-MS
187	Table 6.5-1: Suitability of the measuring system for the rheological characterisation in dependence on the particle structure (BREHMER 2011b)
222	Table 6.9-1: Categorisation of mineral components exclusive of soluble salts in dependence on the particle size
236	Table 7.2-1: PCR reaction set-up for amplification of <i>mcrA</i> genes for 2x concentrated master mix
237	Table 7.2-2: PCR cycling conditions for amplification of <i>mcrA</i> genes
237	Table 7.2-3: Set-up of restriction digestion reaction
241	Table 7.2-4: qPCR protocols for <i>mcrA</i> and 16S rRNA genes using the same primers as described above and the KAPA SYBR® FAST Bio-Rad iCycler® master mix
247	Table 7.3-1: Distribution of the feeding amounts of continuous fermentation tests
293	Table 8.1-1: Members of the KTBL working group "Proficiency Test Biogas Yields"
299	Table 8.2-1: Distribution of the feeding amounts of continuous fermentation tests
299	Table 8.2-2: Overview of the interlaboratory test groups and parameters in the last 14 interlaboratory tests
301	Table 8.2-3: Evaluation of the obtained Z ₀ -scores
347	Table 8.10: The first three measurements of bottle mass and biogas composition for gravimetric BMP determination of an animal feed substrate incubated in a 1 L bottle. Initial mass was 1058.7 g
363	Table 8.11-1: Typical value ranges for first-order hydrolysis kinetics of characteristic nutrients
367	Table 8.11-2: Estimated parameter values (based on a two-step two-fractions model) during simulation of discontinuous anaerobic digestion of pre-treated sugarcane straw (according to JANKE et al. 2017) ^{a)}

372	Table 9.1: Working draft of a catalogue of criteria for the internal and external part of the SWOT analysis (incomplete)
387	Table 9.4-1: Biogas (formation) potential of the fermentable nutrient fractions (adopted from WEISSBACH 2009)
389	Table 9.4-2: Substrate characteristics of the maize silage utilised for the calculation example (WEISSBACH 2009)
409	Table 10.2-1: Measurement principles of sensors
409	Table 10.2-2: Calibration solutions

Table of illustrations

- 68 Figure 4.1-1: Sample chromatogram of a standard solution mixture (C_2-C_6) and a single standard of benzaldehyde
- 71 Figure 4.2-2: Sample chromatogram for the determination of the volatile organic acids with the help of an HPLC (Source: UFZ)
- 71 Figure 4.2-1: Sample chromatogram for the determination of the volatile organic acids with the help of an IC (Source: TU Berlin)
- 73 Figure 4.3-1: GC/MS system (Agilent Technologies, Waldbronn, Germany)
- 74 Figure 4.3-2: Sample chromatogram, analysis of aldehydes, alcohols, ketones, and volatile fatty acids
- 79 Figure 4.4-1: Sample chromatogram of all standard mix solutions used on the RID
- 80 Figure 4.4-2: Sample chromatogram of 5-HMF and furfural at 280 nm
- 85 Figure 4.5-1: Affiliation of the substances; (a) RID: 1) sucrose; 2) D-(+)-glucose; 3) D-(+)-xylose; 4) L-(-)-galactose; 5) acetaldehyde; 6) arabinose; 7) mannose; 8) D-(+)-fructose; 9) glycerol; 10) hydroxyacetone; 11) xylitol; 12) D-(-)-sorbitol; (b) DAD (280 nm): 1) 5-(hydroxymethyl)furfural (5-HMF); 2) furfural
- 89 Figure 4.6-1: Sample chromatogram, analysis of carbohydrate standards
- 89 Figure 4.6-2: Sample diagram, liquid sample from the hydrolysis tank of a biogas plant
- 109 Figure 5.1-1: Principle of vortex method (Source: ABB)
- 110 Figure 5.1-2: Principle of ultrasonic method (Source: Endress & Hauser)
- 111 Figure 5.1-3: Principle of thermal dispersion method (Source: Binder GmbH)
- 111 Figure 5.1-4: Signal level of thermal mass flow meter depending on gas flow rate (Source: Binder GmbH)
- 116 Figure 5.2-1: IR spectra of CO_2 and water vapor (from left to right) (Source: ANSYCO)
- 117 Figure 5.2-2: IR spectra of methane, ethane and propane (from left to right) (Source: ANSYCO)
- 117 Figure 5.2-3: Schematic representation of an electrochemical cell (Source: Binder GmbH)
- 124 Figure 5.3-1: Chromatogram for standard solution, concentration 2.5 mg L^{-1} (Source: Fraunhofer UMSICHT)
- 125 Figure 5.3-2: Sampling and analysis (Source: Fraunhofer UMSICHT)
- 126 Figure 5.3-3: Sampling and analysis (Source: Fraunhofer UMSICHT)
- 127 Figure 5.3-4: Results of sampling at the second test gas cylinder (Source: Fraunhofer UMSICHT)
- 129 Figure 5.3-5: Results of sampling at a wastewater treatment plant (Source: Fraunhofer UMSICHT)
- 133 Figure 5.4-1: Piping and Instrumentation Diagram of the manure storage test stand (Source: DBFZ Masula)
- 134 Figure 5.4-2: Manure storage test stand (Source: DBFZ 2018)
- 135 Figure 5.4-3: Timetable sampling of manure storage test at ambient temperature and methane emission potential test at 20°C (Source: DBFZ)
- 136 Figure 5.4-4: Timetable sampling of manure storage test at ambient temperature and BMP test at 39°C (Source: DBFZ)
- 137 Figure 5.4-5: Methane emission at ambient temperature measured in the storage test stand - Example: sum curve of one test (May - February) with cattle manure on a weekly base (Source: DBFZ)
- 140 Figure 5.5-1: Gas sampling from open biofilters (Source: gewitra)
- 140 Figure 5.5-2: Emission measurements with the tunnel measurement method (wind tunnel) at open composting plants (Source: gewitra)
- 148 Figure 5.6-1a: Weather station (Source: DBFZ)
- 148 Figure 5.6-1b: To the left: reflector modules, to the right: laser spectrometer (Source: DBFZ)
- 149 Figure 5.6-2: Schematic depiction of path-integrated and path-averaged concentration information (Source: DBFZ)
- 156 Figure 5.7-1: Triggering of a PRV in the course of the day; In the exhaust pipe of the PRV, a flow velocity sensor (black line) and a temperature sensor (red line) were installed. Both signals correspond to each other. Modified from (REINELT 2017a)
- 156 Figure 5.7-2: Calculation of the duration of a triggering event based on temperature data.
- 157 Figure 5.7-3: Exemplary measurement setup at the PRVs of an agricultural biogas plant; Left: Flow velocity and temperature sensor installed at the PRV of the main digester (cp. Fig. 5.7-1); Centre: Temperature sensors installed at PRVs of the gastight covered digestate storage; Right: Data logger; Figure modified from (LIEBETRAU et al. 2017)
- 161 Figure 5.8-1: Schematic depiction of the VOC sampling with a 3-bed TD tube (Source: Fraunhofer UMSICHT)

- 162 Figure 5.8-2: Schematic depiction of the thermal desorption with subsequent analysis (Source: Fraunhofer UMSICHT)
- 163 Figure 5.8-3: Chromatogram of a biogas sample (waste fermentation plant) (Source: Fraunhofer UMSICHT)
- 163 Figure 5.8-4: Quantification of octamethylcyclotetrasiloxane (D4) (Source: Fraunhofer UMSICHT)
- 168 Figure 6.1-1: Principle of granulometric assessment (Source: IKTS)
- 170 Figure 6.1-2: Diameter of the projection area identical circle ($x_{D(PL)}$) (Source: IKTS)
- 170 Figure 6.1-3: Cumulative distribution $Q_3(x)$ maize silage untreated (Source: IKTS)
- 172 Figure 6.3-2: Foam generator with model foam (Source: UFZ)
- 173 Figure 6.3-1: Scheme of the foam generator for the determination of the foaming potential of a liquid mixture (Source: UFZ)
- 174 Figure 6.4-1: LEIPZIG FOAM TESTER (Source: Künzelmann, UFZ)
- 175 Figure 6.4-2: Test setup with labelling of the individual components (Source: UFZ)
- 178 Figure 6.5-1: Cylinder measuring system (Source: BREHMER 2011a)
- 180 Figure 6.5-2: Double slit measuring system (Source: BREHMER 2011b)
- 181 Figure 6.5-3: Comparison of different measurement methods using the example of sewage sludge (Source: BREHMER 2011a)
- 181 Figure 6.5-4: Comparison of different measurement methods using the example of a substrate mixture of sewage sludge, fats, and biogenous residues (Source: BREHMER 2011a)
- 183 Figure 6.5-5: Example for the functional dependency of the power input on the Reynolds number for a vane (Source: BREHMER 2011b)
- 184 Figure 6.5-6: Wrapping of the vane shaft with long fibre substrate components (Source: BREHMER)
- 185 Figure 6.5-7: Comparison of different measurement methods using the example of a substrate mixture of maize silage and coarse rye meal (Source: BREHMER 2011a)
- 185 Figure 6.5-8: Adherence of solids to the surface of the ball (Source: BREHMER)
- 186 Figure 6.5-9: Flow diagram for the laminar flow tube (Source: BREHMER 2011a; KRAUME 2004)
- 190 Figure 6.5-10: Measurement method(s) for the determination of the viscosity in dependence on the fibre length (Source: IKTS)
- 191 Figure 6.5-12: Viscosity curve of the digester content (Source: IKTS)
- 191 Figure 6.5-11: ViscoTester 550 with cylinder measuring device (left) and with blade stirrer FL10 (right) for the measurement of fermentation substrates (Source: IKTS)
- 192 Figure 6.5-13: Faulty measurements due to vortex formation and wrapping around a stirrer shaft (Source: IKTS)
- 193 Figure 6.5-14: Approach for the determination of the viscosity according to METZNER & OTTO
- 193 Figure 6.5-15: Test bench for the determination of the apparent viscosity in highly concentrated, fibrous suspensions (Source: IKTS)
- 194 Figure 6.5-16: Performance characteristics of the stirrer system utilised for the viscosity measurement (Source: IKTS)
- 197 Figure 6.5-17: Apparent viscosity in dependence on the rotational frequency for the hydrolysate of a biogas plant (Source: IKTS)
- 197 Figure 6.5-18: Faulty assessment of the viscosity for low-viscous material systems in the case of utilisation of the ViscoPakt®-laboratory stirrer (Source: IKTS)
- 198 Figure 6.5-19: Wrapping around blade stirrer and vortex formation (Source: IKTS)
- 201 Figure 6.6-1: Sensor head of the vane anemometer for the measurement of the velocity in industrial scale biogas plants; built by Fraunhofer UMSICHT (Source: TU Berlin)
- 201 Figure 6.6-2: Example of a lock chamber for rinsing and sealing of the sensor (Source: TU Berlin)
- 202 Figure 6.6-3: Comparison of the flow characteristics of substrates and substitute media (Source: BREHMER 2011c)
- 203 Figure 6.6-4: System components of Particle Image Velocimetry (Source: Lavisoin GmbH 2018)
- 204 Figure 6.6-5: CTA Wheatstone bridge
- 205 Figure 6.6-6: Towing-channel for the calibration and determination of the constants of a film sensor
- 205 Figure 6.6-7: Film sensor
- 206 Figure 6.6-8: Visual comparison of the mixing of two liquids using ERT (Source: ITS 2012)
- 207 Figure 6.6-9: Process tomography (ITS System P2+) at Fraunhofer IKTS

- 207 Figure 6.6-10: Components of the ERT system at Fraunhofer IKTS by means of the example of a cylindrical reactor with a height to diameter ratio of 1 and eight sensor planes.
- 208 Figure 6.6-11: Measuring principle of the ERT system (Source: according to Lee 2009)
- 209 Figure 6.6-12: Visualization of the mixing process inside a cylindrical reactor with five planes of sensors: two-dimensional tomograms (to the left) and three-dimensional illustration of the reactor (to the right) (Source: IKTS)
- 210 Figure 6.6-13: Average mixing quality in dependence on the reactor geometry (Source: IKTS)
- 211 Figure 6.6-14: Velocity profile (to the left) of a suspension consist of xanthan gum and wheat straw (to the right) by using two submersible mixers (Source: IKTS)
- 215 Figure 6.6-15: Vegetative cells, endospores and spores of *Bacillus atrophaeus* (1,000 x) (LTR) (Source: DBFZ)
- 215 Figure 6.6-16: Spore powder of *Bacillus atrophaeus* as final product (Source: DBFZ)
- 217 Figure 6.6-17: Detection of *Bacillus atrophaeus* in surface method on standard I nutrient agar (Source: DBFZ)
- 223 Figure 6.9-1: Setup of sieve machine (Source: SCHNEIDER 2010)
- 224 Figure 6.9-2: Overflow in the case of completed wet screening (Source: SCHNEIDER 2010)
- 225 Figure 6.9-3: Depiction of results of sand determination (Source: SCHNEIDER 2010)
- 226 Figure 6.9-4: Comparison of the screening methods (Source: SCHNEIDER 2010)
- 230 Figure 7.1-1: Typical decomposition kinetics of the standard substrates maize starch and acetic acid and assessment criteria (Source: University of Rostock)
- 244 Figure 7.2-1: Challenges in converting gene-based abundances to microbial biomass or COD for modelling purposes (Source: UFZ)
- 245 Figure 7.3-1: Laboratory scale anaerobic digestion plants at the laboratory of Fraunhofer IKTS
- 246 Figure 7.3-2: Continuous laboratory digestion at Fraunhofer IKTS
- 249 Figure 7.3-3: Pilot biogas plant Fraunhofer IKTS
- 251 Figure 7.4-1: Technical drawing of a digester with a gross volume of 15 L
- 252 Figure 7.4-2: Laboratory for continuous fermentation tests at the DBFZ
- 254 Figure 7.4-3: Tracer concentration in a stirred tank cascade due to a step function in the case of a retention time of 80 d (Source: DBFZ)
- 254 Figure 7.4-4: Gas production and organic loading rate of two continuous fermentation tests in parallel test (Source: DBFZ)
- 255 Figure 7.4-5: Cumulated gas production of two digesters in parallel operation (Source: DBFZ)
- 264 Figure 7.6-1: Multi-channel pipettor, aluminium foil, 96-well plate, and an example for a simple chamber with gas ports for flushing with nitrogen. By simply moving up the box during pipetting, excessive sample contact with oxygen is avoided. When dilution series is completed, the 96-well plate is sealed with the aluminium foil under the nitrogen stream
- 269 Figure 7.7-1: Overview on isotopes of chemical elements ranging from hydrogen to oxygen. The enlarged excerpt shows a simple atomic model of the two stable carbon isotopes with the derivation of their atomic masses based on the different numbers of neutrons. P - protons, N - neutrons
- 270 Figure 7.7-2: Illustration of the delta scale for stable carbon isotope ratios ($^{13}\text{C}/^{12}\text{C}$) as an excerpt ranging from -30 to +30 ‰. The anchor of the $\delta^{13}\text{C}$ -scale is V-PDB (Vienna-Pee Dee Belemnite, $^{13}\text{C}/^{12}\text{C} = 0.0111802$). CSIA - Compound-specific stable isotope analysis
- 271 Figure 7.7-3: Scheme of gas chromatography - combustion - isotope ratio mass spectrometry (GC-C-IRMS) for CSIA of carbon for CH_4 and CO_2
- 271 Figure 7.7-4: Scheme of an example of an IRIS system for CSIA of CO_2
- 272 Figure 7.7-5: Pathways of biogas formation and concept for differentiation of methanogenic pathways in biogas plants using CSIA
- 272 Figure 7.7-6: Differentiation of methanogenic pathways using the comparison of $\delta^{13}\text{C}_{\text{CH}_4}$ - and $\delta^2\text{H}_{\text{CH}_4}$ -values. Modified from CHANTON et al. (2005)
- 274 Figure 7.7-7: Differentiation of methanogenic pathways using the comparison of $\delta^{13}\text{C}_{\text{CH}_4}$ - and $\delta^{13}\text{C}_{\text{CO}_2}$ -values. Modified from WHITIGAR (1999)
- 275 Figure 7.7-8: $\delta^{13}\text{C}_{\text{CH}_4}$ - and $\delta^2\text{H}_{\text{CH}_4}$ -values as well as pattern of methanogenic microorganisms for biogas reactor experiments with chicken manure, dried distillers grains with solubles (DDGS) and maize silage. Modified from NIKOLAUSZ et al. (2013)
- 276 Figure 7.7-9: Changes in $\delta^{13}\text{C}_{\text{CH}_4}$ -values due to the inhibition of biogas production caused by increasing ammonium concentration ($\text{NH}_4\text{-N}$). Modified from Lv et al. (2014)

- 277 Figure 7.7-10: Organic loading rate (OLR), biogas and methane production, concentration of volatile fatty acids (VFA) and acetate, $\delta^{13}\text{C}_{\text{CH}_4}$ - and $\delta^{13}\text{C}_{\text{CO}_2}$ -values as well as proportion of hydrogenotrophic methanogenesis derived from carbon isotope data for a long-term experiment with two biogas reactors (A, B) using DGGs as biogas substrate operated with varying feeding regimes:
 Phase I (Day 1–29): Reactor A and B with daily substrate feeding and OLR of 4 g volatile solids (VS) per litre and day;
 Phase II (Day 30–63): Reactor A with daily substrate feeding and OLR of 4 g VS per litre and day as well as reactor B with substrate feeding every two hours and OLR of 4 g VS per litre and day;
 Phase III (Day 64–107): Reactor A with substrate feeding every two days and OLR of 4 g VS per litre and day as well as reactor B with substrate feeding every two hours and OLR of 4 g VS per litre and day;
 Phase IV (Day 108–118): Reactor A with a substrate feeding every two days and OLR of 5–11 g VS per litre and day as well as reactor B with substrate feeding every two hours and OLR of 5–11 g VS per litre and day.
 SMP - specific methane production, SBP - specific biogas production, HAC eq - acetic acid equivalent of all VFAs. Modified from MULAT et al. (2016)
- 288 Figure 8.1-1: Scattering of the submitted analysis values for comparative laboratory assessment of the methane yield for the sample microcrystalline cellulose as example (VDLUFA and KTBL 2017)
- 289 Figure 8.1-2: Overview of z-values (standardised normal distribution) for the proficiency test samples in the analysis scope 'fermentation test' and residual methane potential, using the example of methane yield (VDLUFA and KTBL 2017). The vertical dashed lines mark a z-value of 2.0 or -2.0. The horizontal dashed lines are auxiliary lines for horizontal orientation. The laboratories are vertical, the samples horizontal. Red bars mark laboratories whose laboratory mean value for this sample is less than -2 or greater than 2 (outlier)
- 290 Figure 8.1-3: Development of the repeatability coefficient (CV_r) in the KTBL/VDLUFA proficiency test biogas (years 2006 to 2017) for the determination of the methane yield of microcrystalline cellulose (reference standard) and maize silage.
 *The change in the objective of the inter-laboratory test from testing the implementation of the VDLUFA method (with plausibility control of incoming laboratory data) to quality assessment of laboratories (without plausibility control of incoming laboratory data) explains the changes in the repeatability coefficients
- 290 Figure 8.1-4: Development of the comparability variation coefficient (CV_g) in the KTBL/VDLUFA proficiency test biogas (years 2006 to 2017) for the determination of biogas and methane yield of microcrystalline cellulose (reference standard) and maize silage.
 *The change in the objective of the inter-laboratory test from testing the implementation of the VDLUFA method (with plausibility control of incoming laboratory data) to quality assessment of laboratories (without plausibility control of incoming laboratory data) explains the changes in the comparative variation coefficients
- 292 Figure 8.1-5: Example of the quality seal (certificate) of the KTBL/VDLUFA Proficiency Test Biogas Yields for the successful participation in the analysis scope 'fermentation test'
- 296 Figure 8.2-1: Representation of various possible analytical error types
- 297 Figure 8.2-2: Development of participants, parameters and samples in comparison. Displayed are the inter-laboratory tests 1–10
- 301 Figure 8.2-3: Schematic sequence of the LfL biogas interlaboratory test (related to the current 12th interlaboratory test)
- 302 Figure 8.2-4: Percentage of laboratories that have positively passed the relevant interlaboratory test group according to the evaluation criteria of the individual tests
- 303 Figure 8.2-5: Interlaboratory tests 4–10: Ring trial group 1: Elements: carbon (C), nitrogen (N) and sulfur (S); Percentage of laboratories whose analytics were rated a Zu-score of > |2|
- 305 Figure 8.3-1: Batch test system of LfL
- 307 Figure 8.3-2: Schematic diagram of the batch test system of LfL. D: digester, MGC: Milligascounter, SV: solenoid valve (DANDIKAS et al. 2015)
- 310 Figure 8.4-1: Batch reactors (1 litre scale), water bath, gas meter, gas bag (Source: IKTS)
- 312 Figure 8.4-2: Batch gas production test – feed-specific gas amounts (Source: IKTS)
- 321 Figure 8.6-1: Sample gas yield graphs before and after a disintegration by means of NaOH (Source: IKTS)
- 323 Figure 8.7-1: Dry batch digestion pilot plant at AITF. The pictures show the front of the system (left) and back (right) with a round percolation digester in the back (Source: InnoTech)
- 324 Figure 8.7-2: Overall process schematic (Source: InnoTech)

- 325 Figure 8.7-3: Pneumatic piston beneath dry digester and grating pulled down onto material to simulate pressure from material height inside the bunker (Source: InnoTech)
- 326 Figure 8.7-5: Paddle mixer used to prepare substrate mixtures for dry digestion (Source: InnoTech)
- 326 Figure 8.7-4: Aeration header in the base of the dry digester converted for use as an aeration bunker, the vertical rods for the substrate compression system are also visible (Source: InnoTech)
- 327 Figure 8.7-7: Pipe segment drainage channels placed and installed beneath the grating (Source: InnoTech)
- 327 Figure 8.7-6: Dry digester pilot vessel with slotted PVC piping on the floor and the floor grating in the background. The rods that pull down on the compression grating system are also visible (Source: InnoTech)
- 328 Figure 8.7-8: Cumulative biogas and methane production, daily percolation volumes and an 85% of biomethane potential target marker (based on feedstock BMP) for Digester 1 throughout the Trial (Source: InnoTech)
- 328 Figure 8.7-9: Cumulative biogas and methane production from the percolation digester during the Trial (Source: InnoTech)
- 328 Figure 8.7-10: Biogas compositional data from Digester 1 and 2 throughout the trial (Source: InnoTech)
- 329 Figure 8.7-11: Biogas compositional data from the percolation digester throughout the trial (Source: InnoTech)
- 329 Figure 8.7-12: Cumulative percolate returned to the percolate digester from dry Digesters 1 and 2 and percolate volume in the percolate digester throughout the trial (Source: InnoTech)
- 329 Figure 8.7-13: Cumulative quantity and rate of percolate returned to the percolate digester from dry Digesters 1 and 2 throughout the trial (Source: InnoTech)
- 330 Figure 8.7-14: Total alkalinity, total organic acids and pH for the percolate digester and dry Digesters 1 and 2 during the trial (Source: InnoTech)
- 330 Figure 8.7-15: Total alkalinity, total organic acids and total ammoniacal nitrogen for the percolate digester and dry Digesters 1 and 2 during the trial (Source: InnoTech)
- 330 Figure 8.7-16: Digester 1 and Digester 2, open at the end of the trial with post digestion contents visible (Source: InnoTech)
- 332 Figure 8.8-1: Left side: Schematic structure of the water bath (left) with swivel mechanism. Right side: Schematic structure of the test bottle with ATM / N pressure transmitter and device for sampling from headspace volume
- 333 Figure 8.8-2: Part of the screenshot to record the existing pressures at the individual measuring points. Green \triangle Ambient pressure, red \triangle Perm. Max. Pressure. Blue corresponds to the prevailing pressure at each measuring point
- 334 Figure 8.8-3: Averaged pressure course of the biocenosis SB2 after addition of 50 mg mycophenolic acid (Myko 50 mg)
- 335 Figure 8.8-4: Methane and nitrogen content course (left) and hydrogen and hydrogen sulfide content (right) during the course of the experiment after 50 mg L⁻⁴ mycophenolic acid for biocenosis SB2
- 349 Figure 8.11-1: Effects of changes in biogas or methane potential and degradation kinetics on cumulative gas production during discontinuous (batch) operation (Source: WEINRICH et al. 2018)
- 353 Figure 8.11-2: Simplified model structures based on superposition of first-order reactions kinetics (adapted from BRULÉ et al. 2014)
- 356 Figure 8.11-3: Flow chart of the fundamental procedure for estimating unknown model parameter values
- 359 Figure 8.11-4: Different examples of data transformation for parameter estimation during discontinuous anaerobic digestion of straw: (a) cumulative specific biogas production, (b) specific biogas production rate, (c) linearisation of first-order kinetics and (d) linearisation of MONOD-type kinetics
- 365 Figure 8.11-5: Model-based approximation of the specific biogas potential and reaction kinetics during discontinuous anaerobic degradation of maize silage
- 366 Figure 8.11-6: Parameter estimation during anaerobic digestion microcrystalline cellulose evincing a clear lag phase
- 366 Figure 8.11-7: Experimental and simulation results during alkaline pre-treatment of sugarcane straw (based on JANKE et al. 2017)
- 374 Figure 9.2-1: Schematic for the determination the plant index (Source: TU Braunschweig)
- 375 Figure 9.2-2: Mathematical depiction regarding the calculation of the plant index (both figures) (Source: TU Braunschweig)
- 380 Figure 9.3-1: Example of a measuring cell of a respirometer

- 381 Figure 9.4-1: Mass balancing of a biogas digester (Source: DBFZ)
- 392 Figure 9.4-2: Calculation scheme of a straightforward mass balancing for the mono fermentation of maize silage (WEINRICH 2014)
- 394 Figure 9.5-1: Structure of the multilevel fuzzy-logic rule base. Rule-levels R1, R2, R3 are calculated consecutively. R1: rule for calculating states; R2: rules for calculating global measures; R3: rules for calculating output variables
- 395 Figure 9.5-2: Fuzzy input variable for hydrogen showing a measurement value of 300 ppm, which is 67 % normal and 33 % high
- 395 Figure 9.5-3: Fuzzy output variable for feed that gives a defuzzified value of 0.67 (using the center of gravity method)
- 397 Figure 9.5-4: CHP power (left y-axis; A, dark (blue)) vs. gas storage level (right y-axis, H, orange). A0: CHP runs with full power, A1: reduced power, A2 and A3: see text.; H1-, H2-: stop of substrate dosage; H1+, H2+: restart of substrate dosage
- 401 Figure 10.1-1: Amperometric hydrogen sensor (Source: KSI)
- 401 Figure 10.1-2: Measuring system for the determination of dissolved gases in biogas media: (A) control unit; (B) mass flow controller; (C) manometer; (D) extraction unit in biogas medium; (E) filter; (F) field gas chromatograph; (G) coulometric detector, and (H) back-pressure regulator (Source: KSI)
- 403 Figure 10.1-3: Online measurement of the dissolved hydrogen and the dissolved oxygen in a biogas plant, feeding times marked with arrows, red = solid cattle dung, black = maize silage, grey = cattle manure (Source: KSI)
- 403 Figure 10.1-4: Online measurement of the dissolved hydrogen and the hydrogen in the biogas in a biogas laboratory system whose microbiology is being stressed increasingly by increasing the organic loading rate; feeding times indicated by arrows, feeding amounts specified as organic loading rate (Source: KSI)
- 407 Figure 10.2-1: Multi-parameter sensor devices. Top: Larger device with commercially available sensors (Exner Process Equipment (EPE), Germany); Bottom: Smaller device with miniaturised sensors (developed by Kurt-Schwabe-Institut Meinsberg (KSI), Germany)
- 408 Figure 10.2-2: Applied sensors for measurements: Top: ARC sensors (Hamilton Messtechnik, Germany); Bottom: Miniaturised selfmade sensors (Kurt-Schwabe-Institut Meinsberg (KSI), Germany), (SACHSE et. al 2015)
- 408 Figure 10.2-3: Application of the miniaturised sensor device in a digester with a flexible roof (B). Horizontal and vertical access is realized by a gate valve (B), a lance and a flexible rope (A)
- 410 Figure 10.2-4: Investigation of redox potential gradients with the miniaturised sensor device in a 920 m³ biogas digester (KIELHORN et. al 2015)
- 411 Figure 10.2-5: Investigation of conductivity, redox potential, pH-value, and temperature gradients with commercial sensors in a 920 m³ biogas digester (KIELHORN et. al. 2015).
- 415 Figure 10.3-1: The Automatic Methane Potential Test System (AMPTS II) (Bioprocess Control Sweden AB)
- 417 Figure 10.3-2: Typical curves obtained for the accumulated volume of biomethane (up) and flow rate of the gas produced (down) using AMPTS for triplicate positive control substrate (i.e., cellulose) at different inoculum to substrate ratios (2, 4, 6)
- 420 Figure 10.4-1: Infrared absorption spectra of methane, ethane, propane and carbon dioxide from 3.0 to 5.0 μm
- 420 Figure 10.4-2: Infrared absorption spectra of methane, ethane, propane and carbon dioxide from 6.0 to 9.0 μm
- 422 Figure 10.4-3: Concentration-dependent infrared absorption of methane at 3.4 μm with background gas nitrogen or carbon dioxide
- 422 Figure 10.4-4: Concentration-dependent infrared absorption of carbon dioxide at 4.3 μm with background gas nitrogen or methane
- 422 Figure 10.4-5: Concentration-dependent infrared absorption of carbon dioxide at 4.3 μm with background gas nitrogen or methane (high range)
- 425 Figure 10.5-1: Permeability and Cumulative Compaction of different sample materials
- 426 Figure 10.5-2: Test apparatus for permeability measurement
- 427 Figure 10.5-3: Permeability and Cumulative Compaction of different sample materials

Table of literature

- ABDO Z, SCHUETTE UME, BENT SJ, WILLIAMS CJ, FORNEY LJ, JOYCE P (2006): Statistical methods for characterizing diversity of microbial communities by analysis of terminal restriction fragment length polymorphisms of 16S rRNA genes. In: *Environmental Microbiology*, Vol. 8, No. 5, pp. 929-938
- AHN H K, RICHARD T L, GLANVILLE T D, (2008): Laboratory determination of compost physical parameters for modeling of airflow characteristics. In: *Waste Manage.* 2008, 28 (3), 660–670. DOI: 10.1016/j.wasman.2007.04.008
- ANDERSON G, CAMPOS C, CHERNICHARO L, SMITH L (1991): Evaluation of the inhibitory effects of lithium when used as a tracer for anaerobic digesters. In: *Water Research*, Vol. 25, No. 7, pp. 755–760
- ANSYCO: Collection of IR spectra. www.ansyco.de/technologie/ir-spektren
- ANGELIDAKI I, ELLEGAARD L, AHRING BK (1999): A comprehensive model of anaerobic bioconversion of complex substrates to biogas. In: *Biotechnology and Bioengineering*, Vol. 63, No. 3, pp. 363–372
- ANGELIDAKI I, ALVES M, BOLZONELLA D, BORZACCONI L, CAMPOS JL, GUWY AJ, KALYZHNYI S, JENICEK P, VAN LIER JB (2009): Defining the biomethane potential (BMP) of solid organic wastes and energy crops: a proposed protocol for batch assays. In: *Water Science and Technology* 59, pp. 927–934. <https://doi.org/10.2166/wst.2009.040>
- ASTALS S, BATSTONE D J, MATA-ALVAREZ J, JENSEN P D (2014): Identification of synergistic impacts during anaerobic co-digestion of organic wastes. In: *Bioresource Technology*, Vol. 169, pp.421–427
- BANEMANN D (2012): Mündliche Mitteilung 29.9.2012 [Oral communication, 2012, Sep 26]
- BARKER SB & SUMMERSON WH (1941): The Colorimetric Determination of Lactic Acid in Biological Material. In: *Journal of Biological Chemistry*, Vol. 135, S. 535–554
- BASTIN G, DOCHAIN D (1990): On-line estimation and adaptive control of bioreactors. Elsevier, Amsterdam
- BATSTONE DJ, KELLER J, ANGELIDAKI I, KALYZHNY S, PAVLOSTATHIS SG, ROZZI A, SANDERS W, SIEGRIST H, VALIN V (2002): The IWA Anaerobic Digestion Model No 1 (ADM1). In: *Water Science & Technology*, Vol. 45, No. 10, pp. 65–73
- BATSTONE D J, PIND P F, ANGELIDAKI, I (2003): Kinetics of Thermophilic, Anaerobic Oxidation of Straight and Branched Chain Butyrate and Valerate. In: *Biotechnology and Bioengineering*, Vol. 84, No. 2, pp 195–204
- BATSTONE D J, TAIT S, STERRENBURG D (2009): Estimation of Hydrolysis Parameters in Full-Scale Anaerobic Digesters. In: *Biotechnology & Bioengineering*, Vol. 102, No.5, pp 1513–1520
- BATSTONE D J, PUYOL D, FLORES-ALSINA X, RODRIGUEZ J (2015): Mathematical modelling of anaerobic digestion processes applications and future needs. In: *Reviews in Environmental Science and Biotechnology*, Vol. 14, No. 4, pp. 595–613
- BRAND WA, COPLEN TB (2012): Stable isotope deltas: Tiny, yet robust signatures in nature. In: *Isotopes Environ. Health Stud.* 48 (3), pp. 393-409
- BERNARD O, HADJ-SADOK Z, DOCHAIN D, GENOVESI A, STEYER J P (2001): Dynamical Model Development and Parameter Identification for an Anaerobic Wastewater Treatment Process. In: *Biotechnology and Bioengineering*, Vol. 75, No. 4, pp. 425–438
- BIERNACKI P, STEINIGEWEG S, BORCHERT A, UHLENHUT, F (2013): Application of Anaerobic Digestion Model No. 1 for describing anaerobic digestion of grass, maize, green weed silage, and industrial glycerine. In: *Bioresource Technology*, Vol. 127, pp. 188–194
- BIERWERTH W (2011): Tabellenbuch Chemietechnik: Daten, Formeln, Normen, vergleichende Betrachtungen [Table book chemistry technology: Data, formulas, standards]. 8th ed., Haan-Gruiten: Verlag Europa-Lehrmittel – ISBN 978-3-8085-7088-3

- BioAbfV (1998, 2013, 2017): Verordnung über die Verwertung von Bioabfällen auf landwirtschaftlich, forstwirtschaftlich und gärtnerisch genutzten Böden (Bioabfallverordnung – BioAbfV) [Ordinance regarding the utilisation of biowastes on agriculturally, silviculturally and horticulturally utilised soils (Biowastes Ordinance – BioAbfV)]
- BioAbfV (2007): Novellierung der BioAbfV, Anhang 2 [Amendment to BioAbfV, Appendix 2]
- BOLGER AM, LOHSE M, USADEL B (2014): Trimmomatic: A flexible trimmer for Illumina sequence data. In: *Bioinformatics*, Vol. 30, No. 15, pp. 2114-2120
- BLODGETT R. (2010): BAM Appendix 2: Most Probable Number from Serial Dilutions. In: Bacteriological Analytical Manual, US Food and Drug Administration. <https://www.fda.gov/Food/FoodScienceResearch/LaboratoryMethods/ucm109656.htm> (Status: 18.10.2018)
- BRANKATSCHK R, BODENHAUSEN N, ZEYER J, BURGMANN H (2012): Simple absolute quantification method correcting for quantitative PCR efficiency variations for microbial community samples. In: *Applied and Environmental Microbiology*, Vol. 78, No. 12, pp. 4481-4489
- BÜHLIGEN F, LUCAS R, NIKOLAUSZ M, KLEINSTEUBER S (2016): A T-RFLP database for the rapid profiling of methanogenic communities in anaerobic digesters. In: *Anaerobe*, Vol. 39, pp. 114-116
- BORROTO J, DOMINGUEZ J, GRIFFITH J, FICK M, LECLERC J (2003): Technetium-99 m as a tracer for the liquid RTD measurement in opaque anaerobic digester: Application in a sugar wastewater treatment plant. In: *Chemical Engineering and Processing*, Vol. 42, No. 11, pp. 857–865
- BOYLE WC (1976): Energy Recovery from Sanitary Landfills – a review. In: *Microbial Energy Conversion*. Schlegel HG & Barnea J (Eds.), Oxford: Pergamon Press
- BOLYEN E, RIDEOUT J R, DILLON M R, BOKULICH N A, ABNET C C, AL-GHALITH G A, CAPORASO J G (2019). Reproducible, interactive, scalable and extensible microbiome data science using QIIME 2. In: *Nature Biotechnology*, 37(8), 852– 857. DOI: 10.1038/s41587-019-0209-9
- BREHMER M & KRAUME M (2011a): Rheological properties of substrates for the biogas production from renewable resources, poster at congress "Progress in Biogas II", March 30–31, Stuttgart
- BREHMER M & KRAUME M (2011b): Rheologische Charakterisierung von Gärsubstraten [Rheological characterization of fermenting substrates], talk at colloquium "14. Köthener Rührerkolloquium", June 16, Köthen
- BREHMER M, EPPINGER T, KRAUME M (2011c): Fluidynamische Untersuchungen zur Optimierung von Biogasanlagen [Fluid-dynamic tests regarding the optimisation of biogas plants], talk at congress "4. biogas – expo & congress", Oct 26–27, Offenburg
- BRULÉ M, OECHSNER H, JUNGBLUTH T (2014): Exponential model describing methane production kinetics in batch anaerobic digestion: a tool for evaluation of biochemical methane potential assays. In: *Bioprocess and Biosystems Engineering*, Vol. 37, No. 9, pp. 1759–1770
- BUCHAUER K (1998): A comparison of two simple titration procedures to determine volatile fatty acids in influents to wastewater and sludge treatment processes. In: *Water SA*, Vol. 24, No. 1, pp. 49–56
- BURCHARD CH, GROCHE D, ZERRES HP (2001): Handbuch einfacher Messungen und Untersuchungen auf Klärwerken [Handbook of simple measurements and investigation in wastewater treatment plants], 10th ed., ATV-DVWK (Eds.), München: Hirthammer – ISBN 3-921288-25-8
- BUSTIN SA, BENES V, GARSON JA, HELLEMANS J, HUGGETT J, KUBISTA M, MUELLER R, NOLAN T, PFAFF MW, SHIPLEY GL, VANDESOMPELE J, WITTWER CT (2009): The MIQE guidelines: Minimum information for publication of quantitative real-time PCR experiments. In: *Clinical Chemistry*, Vol. 55, No. 4, pp. 611-622
- BUSWELL AM & MUELLER HF (1952): Mechanism of Methane Fermentation. In: *Industrial & Engineering Chemistry*, Vol. 44, No. 3, pp. 550–552 – DOI: 10.1021/ie50507a033

- CALLAHAN BJ, McMURDIE PJ, ROSEN MJ, HAN AW, JOHNSON AJA, HOLMES SP (2016): DADA2: High-resolution sample inference from Illumina amplicon data. In: *Nature Methods*, Vol. 13, No. 7, pp. 581-583
- CAPORASO JG, KUCZYNSKI J, STOMBAUGH J, BITTINGER K, BUSHMAN FD, COSTELLO EK, FIERER N, PENNA AG, GOODRICH JK, GORDON JI, HUTTLEY GA, KELLEY ST, KNIGHTS D, KOENIG JE, LEY RE, LOZUPONE CA, McDONALD D, MUEGGE BD, PIRRUNG M, REEDER J, SEVINSKY JR, TUMBAUGH PJ, WALTERS WA, WIDMANN J, YATSUNENKO T, ZANEVELD J, KNIGHT R (2010): QIIME allows analysis of high-throughput community sequencing data. In: *Nature Methods*, Vol. 7, No. 5, pp. 335-336
- CETECIOGLU Z, INCE B, GROS M, RODRIGUEZ-MOZAS S, BARCELÓ D, INCE O, ORHON D (2015): Biodegradation and reversible inhibitory impact of sulfamethoxazole on the utilization of volatile fatty acids during anaerobic treatment of pharmaceutical industry wastewater. In: *Science of The Total Environment*, Vol. 536, pp. 667-674
- CHANTON JP, CHASAR LC, GLASER P, SIEGEL D (2005): Chapter 6, Carbon and hydrogen isotopic effects in microbial methane from terrestrial environments. In: *Flanagan, L.B., Ehleringer, J.R., Pataki, D.E. (Eds.), Stable Isotopes and Biosphere-Atmosphere Interactions, Physiological Ecology Series*. Elsevier-Academic Press, pp. 85-105
- CLAUSS T, REINELT T, LIEBETRAU J, VESENMAIER, A, REISER M, FLANDORFER C, STENZEL S, PIRINGER M, FREDENSL AM, SCHEUTZ C, HRAD M, OTTNER R, HUBER-HUMER M, INNOCENTI F, HOLMGREN M, YNGVESSON J (2019): Recommendations for reliable methane emission rate quantification at biogas plants. DBFZ-Report No. 13. ISSN: 2197-4632 (Online), ISBN: 978-3-946629-43-6
- COPLIN TB (2011): Guidelines and recommended terms for expression of stable-isotope-ratio and gas-ratio measurement results. In: *Rapid Commun. Mass. Spectrom.* 25 (17), pp. 2538-2560
- CRENNA BP, FLESCH TK, WILSON JD (2008): Influence of source-sensor geometry on multi-source emission rate estimates. In: *Atmospheric Environment*, Vol. 42, No. 32, pp. 7373-7383
- CRUWYS JA, DINSDALE RM, HAWKES FR, HAWKES DL (2002): Development of a static headspace gas chromatographic procedure for the routine analysis of volatile fatty acids in wastewaters. In: *Journal of Chromatography A*, Vol. 945, No. 1-2, pp. 195-209
- DANCKWERTS PV (1953): Continuous flow systems - distribution of residence times. In: *Chemical Engineering Science*, Vol. 2, pp. 1-13
- DANIEL-GROMKE J, RENSBERG N, DENYSENKO V, STINNER W, SCHMALFUSS T, SCHEFTELOWITZ M, NELLES M, LIEBETRAU J (2017): Current Developments in Production and Utilization of Biogas and Biomethane in Germany. CIT, WILEY-VCH Verlag GmbH & Co. KGaA, Weinheim. <https://doi.org/10.1002/cite.201700077>
- DANDIKAS V, HEUWINKEL H, LICHTI F, DREWES J E, KOCH K (2015): Correlation between Biogas Yield and Chemical Composition of Grassland Plant Species. In: *Energy & Fuels* 29 (11): 7221-7229
- DEBATIN K (1997): Experimentelle Strömungsmechanik, ergänzendes Skript zur Vorlesung [Experimental flow mechanics, supplemental script to the lecture]. KIT, Institut für Strömungsmechanik
- DEERBERG G, GRÄN-HEEDFELD J, HENNIG T, DUDLIK A (2009): Strömungs- und Wärmetransportoptimierung in Biogasanlagen - Abschlussbericht [Optimization of fluid flow and heat transfer in biogas plants - final report]. Oberhausen: Fraunhofer UMSICHT
- DE VRIEZE J, GILDEMYN S, VILCHEZ-VARGAS R, JÁUREGUI R, PIEPER DH, VERSTRAETE W, BOON N (2015): Inoculum selection is crucial to ensure operational stability in anaerobic digestion. In: *Applied Microbiology and Biotechnology*, Vol. 99, No. 1, pp. 189-199
- DIN 1343:1990-01 (1990): Reference conditions, normal conditions, normal volume; concepts and values [Referenzzustand, Normzustand, Normvolumen; Begriffe und Werte]. Berlin: DIN Deutsches Institut für Normung e. V., Beuth Verlag
- DWA-M 264 (2015): Gas flow measurement for waste water treatment systems [Gasdurchflussmessungen auf Abwasserbehandlungsanlagen]. DWA Set of rules. Beuth Verlag
- DIN 18130-1:1998-05 (1998): Soil - investigation and testing; Determination of the coefficient of water permeability - Part 1: Laboratory tests; Berlin: DIN Deutsches Institut für Normung e. V., Beuth Verlag

- DIN 38402-45 (2014): German standard methods for the examination of water, waste water and sludge – General information (group A) – Part 45: Interlaboratory comparison for proficiency testing of laboratories (A45). Ed. Beuth Verlag GmbH, Berlin
- DIN 38409-7 (2005): Deutsche Einheitsverfahren zur Wasser-, Abwasser- und Schlammuntersuchung: Summarische Wirkungs- und Stoffkenngrößen (H) – Bestimmung der Säure- und Basekapazität (H7) [German standard methods for the examination of water, waste water and sludge: Parameters characterizing effects and substances (H) – Determination of acid and base-neutralizing capacities (H7)]. Berlin: DIN Deutsches Institut für Normung e. V., Beuth Verlag
- DIN 38414-19 (1999): Deutsche Einheitsverfahren zur Wasser-, Abwasser- und Schlammuntersuchung: Schlamm und Sedimente (S) – Bestimmung der wasserdampfächtigen organischen Säuren (S 19) [German standard methods for the examination of water, waste water and sludge: Sludge and sediments (S) – Determination of the steam-volatile organic acids (S19)]. Berlin: DIN Deutsches Institut für Normung e. V., Beuth Verlag
- DIN EN ISO 5167-1 (2003): Measurement of fluid flow by means of pressure differential devices inserted in circular cross-section conduits running full - Part 1: General principles and requirements (ISO 5167-1:2003); [Durchflussmessung von Fluiden mit Drosselgeräten in voll durchströmten Leitungen mit Kreisquerschnitt - Teil 1: Allgemeine Grundlagen und Anforderungen]. Beuth Verlag
- DIN ISO 5725-1 (1997): Accuracy (trueness and precision) of measurement methods and results - Part 1: General principles and definitions. Ed. Beuth Verlag GmbH, Berlin
- DIN ISO 5725-2 (2002): Accuracy (trueness and precision) of measurement methods and results - Part 2: Basic method for the determination of repeatability and reproducibility of a standard measurement method. Ed. Beuth Verlag GmbH, Berlin
- DOCHAIN D, VANROLLEGHEM P (2001): Dynamical Modelling and Estimation in Wastewater Treatment Processes. IWA Publishing, London
- DOCHAIN D, VANROLLEGHEM P A, DAELE M V (1995): Structural identifiability of biokinetic models of activated sludge respiration. In: *Water Research*, Vol. 29, No. 11, pp. 2571–2578
- DOMINIK P, JÄGER N, SÄNGER A, FLESSA, H (2009): Wie wirken NaWaRo-Gärreste auf den organischen Bodenkohlenstoff? [What impact do digestates from renewable resources have on the organic soil carbon?] In: *Biogas in der Landwirtschaft – Stand und Perspektiven*, Vol. 32, Weimar: KTBL/FNR Biogas Kongress
- DONGSO-BRAVO A, MAILIER J, MARTIN C, RODRIGUEZ J, ACEVES-LARA C A, WOUWER, A V (2011): Model selection, identification and validation in anaerobic digestion: A review. In: *Water Research*, Vol. 45, No. 17, pp. 5347–5364
- DONGSO-BRAVO A, MAILIER J, RUIZ-FILIPPI G, WOUWER A V (2013): Identification in an anaerobic batch system: global sensitivity analysis, multi-start strategy and optimization criterion selection. In: *Bioprocess and Biosystems Engineering*, Vol. 36, No. 1, pp. 35–43
- DONGSO-BRAVO A, PÉREZ-ELVIRA S I, FDZ-POLANCO F (2010): Application of simplified models for anaerobic biodegradability test. Evaluation of prt-treatment processes. In: *Chemical Engineering Journal*, Vol. 160, pp. 607–614
- DUMAS JB (Ed.) (1831): *Annales de Chimie et de Physique [Annals of Chemistry and Physics]*, Vol. 47
- DYSON R (2004): Strategic development and SWOT analysis at the University of Warwick. In: *European Journal of Operational Research*, Vol. 152, No. 3, pp. 631–640
- EASTMAN J A, FERGUSON J F (1981): Solubilization of Particulate Organic Carbon during the Acid Phase of Anaerobic Digestion. In: *Journal Water Pollution Control Federation*, Vol. 53, No. 3, pp. 352–366
- ECKELMANN H (1997): Einführung in die Strömungsmesstechnik [Introduction to flow measurement engineering], In: *Leitfäden der angewandten Mathematik und Mechanik*, Vol. 74, Stuttgart: Teubner – ISBN 3-519-02379-2

- ENGLER N, MERRETIG-BRUNS U, FEHER A, FRITZ TH, NELLES M (2011): Der ORGA-Test: Entwicklung eines Testverfahrens zur praxisnahen Beurteilung der Fermenterbiologie in NawaRo-Biogasanlagen [The ORGA Test: Development of a test method for the practise-focused assessment of the digester biology in renewable resources biogas plants]. In: *Gülfzower Fachgespräche*, Vol. 35, Gülfzow: FNR (Ed.)
- ESPOSITO G, FRUNZO L, PANICO A, D'ANTONIO G (2008): Mathematical modelling of disintegration-limited co-digestion of OFMSW and sewage sludge. In: *Water Science Technology*, Vol. 58, No. 7, pp. 1513–1519
- FLESCH TK, WILSON D, HARPER LA, CRENNAN BP, SHARPE RR (2004): Deducing Ground-to-Air Emissions from Observed Trace Gas Concentrations: A Field Trial. In: *Journal of Applied Meteorology*, Vol. 43, No. 3, pp. 487–502
- FLESCH TK, WILSON D, HARPER LA, CRENNAN BP (2005): Estimating gas emissions from a farm with an inverse-dispersion technique. In: *Atmospheric Environment*, Vol. 39, No. 27, pp. 4863–4874
- FLESCH TK, WILSON D, HARPER LA (2005): Deducing Ground-to-Air Emissions from Observed Trace Gas Concentrations: A Field Trial with Wind Disturbance. In: *Journal of Applied Meteorology*, Vol. 44, No. 4, pp. 475–484
- FLESCH TK, DESJARDINS RL, WORTH D (2011): Fugitive methane emissions from an agricultural biogas digester. In: *Biomass and Bioenergy*, Vol. 35, No. 9, pp. 3927–3935
- FLESCH TK, WILSON JD, YEE E (1995): Backward-time Lagrangian stochastic dispersion models and their application to estimate gaseous emissions. In: *Journal of Applied Meteorology*, Vol. 34, No. 6, pp. 1320–1332
- FOKEN T (2003): *Angewandte Meteorologie: Mikrometeorologische Methoden* [Applied meteorology: Micro-meteorological methods]. Berlin: Springer Verlag – ISBN 978-3-540-38202-7
- FRANKO U, OELSCHLÄGEL B (1995): Einfluss von Klima und Textur auf die biologische Aktivität beim Umsatz der organischen Bodensubstanz [Impact of climate and texture on the biological activity in the conversion of organic soil substance]. In: *Archiv für Acker- und Pflanzenbau und Bodenkunde*, Vol. 39, pp. 155–163
- FRITZ T (2009): Entwicklung, Implementierung und Validierung eines praxisnahen Verfahrens zur Bestimmung von Biogas- bzw. Methanerträgen [Development, implementation and validation of a practical method for determining biogas and methane yields]. Dissertation Universität Rostock, Agrar- und Umweltwissenschaftliche Fakultät. <http://purl.uni-rostock.de/rosdok/id00000588>
- GAO Z, DESJARDINS RL, FLESCH TK (2010): Assessment of the uncertainty of using an inverse-dispersion technique to measure methane emissions from animals in a barn and in a small pen. In: *Atmospheric Environment*, Vol. 44, No. 26, pp. 3128–3134
- GAVALA H N, ANGELIDAKI I, AHRING B K (2003): Kinetics and Modeling of Anaerobic Digestion Process. In: AHRING, B K (Ed.): *Biomethanation I*. Springer, Berlin, pp. 57–934
- GOLDBERG D E (1989): *Genetic Algorithms in Search, Optimization, and Machine Learning*. Addison Wesley Publishing
- GOMPERTZ B (1825): On the Nature of the Function Expressive of the Law of Human Mortality, and on a New Mode of Determining the Value of Life Contingencies. In: *Philosophical Transactions of the Royal Society*, Vol. 115, pp. 513–583
- GOODWIN S, McPHERSON JD, McCOMBIE WR (2016): Coming of age: ten years of next-generation sequencing technologies. In: *Nature Reviews Genetics*, Vol. 17, No. 6, pp. 333-351
- GÖRTZ G & MEISSAUER G (Inventors) (2003): Verfahren zur Bestimmung flüchtiger Fettsäuren (VFA) in anaeroben Fermentaten [Methods for the determination of volatile fatty acids (VFA) in anaerobic fermentates]. Patent DE10134658C2, Schmack Biogas AG (Applicant)
- GÜLLERT S, FISCHER MA, TURAEV D, NOEBAUER B, ILMBERGER N, WEMHEUER B, ALAWI M, RATTEI T, DANIEL R, SCHMITZ RA, GRUNDHOFF A, STREIT WR (2016): Deep metagenome and metatranscriptome analyses of microbial communities affiliated with an industrial biogas fermenter, a cow rumen, and elephant feces reveal major differences in carbohydrate hydrolysis strategies. In: *Biotechnology for Biofuels*, Vol. 9, No. 1, pp. 121

- GYÖRGY A, KOCSSIS L (2011): Efficient Multi-Start Strategies for Local Search Algorithms. In: *Journal of Artificial Intelligence Research*, Vol. 41, pp. 407–444
- HAFNER S D, ASTALS S (2019): Systematic error in manometric measurement of biochemical methane potential: Sources and solutions. In: *Waste Management*, 91, 147–155. DOI: <https://doi.org/10.1016/j.wasman.2019.05.001>
- HAFNER, S D, FRUTEAU DE LACLOS H, KOCH K, HOLLIGER C (2020): Improving Inter-Laboratory Reproducibility in Measurement of Biochemical Methane Potential (BMP). In: *Water*, 12, 1752. DOI: <https://doi.org/10.3390/w12061752>
- HAFNER S D, KOCH K, CARRERE H, ASTALS S, WEINRICH S, RENUIT C (2018): Software for biogas research: Tools for measurement and prediction of methane production. *SoftwareX* 7, pp. 205–210. <https://doi.org/10.1016/j.softx.2018.06.005>
- HAFNER S D, RENUIT C, TRIOLO J M, RICHARDS B K (2015): Validation of a simple gravimetric method for measuring biogas production in laboratory experiments. In: *Biomass and Bioenergy*, Vol. 83, pp. 297–301. <https://doi.org/10.1016/j.biombioe.2015.10.003>
- HAFNER SD, KOCH K, CARRERE H, ASTALS S, WEINRICH S, RENUIT C (2018): Software for biogas research: Tools for measurement and prediction of methane production. In: *SoftwareX*, Vol. 7, pp. 205–201
- HAGEN LH, FRANK JA, ZAMANZADEH M, EIJNSINK VGH, POPE PB, HORN SJ, ARNTZEN MØ (2017): Quantitative Metaproteomics Highlight the Metabolic Contributions of Uncultured Phylotypes in a Thermophilic Anaerobic Digester. In: *Applied and Environmental Microbiology*, Vol. 83, No. 2, pp. e01955-16
- HEERTJES P, KUIJVENHOVEN L, VAN DEN MEER R (1982): Fluid flow pattern in upflow reactors for anaerobic treatment of beet sugar factory wastewater. In: *Biotechnology and Bioengineering*, Vol. 24, No. 2, pp. 443–459
- HERWIG H (2006): *Strömungsmechanik [Flow mechanics]*. 2nd ed., Berlin: Springer Verlag – ISBN 978-3-540-32441-6
- HEUWINKEL H, ASCHMANN A, GERLACH R, GRONAUER A (2009): Die Genauigkeit der Messung des Gasertragspotentials von Substraten mit der Batchmethode [The accuracy of measuring the gas yield potential of substrates with the batch method]. Internationale Wissenschaftstagung Biogas Science 2009, 02-04 Dezember 2009, Erding, Band 1
- HOLLIGER C, ALVES M, ANDRADE D, ANGELIDAKI I, ASTALS S, BAIER U, BOUGRIER C, BUFFIÈRE P, CARBELLA M, DE WILDE V, EBERTSEDER F, FERNÁNDEZ B, FICARA E, FOTIDIS I, FRIGON J-C, FRUTEAU DE LACLOS H, S. M. GHASIMI D, HACK G, HARTTEL M, HEERENKLAGE J, SARVARI HORVATH I, JENICEK P, KOCH K, KRAUTWALD J, LIZASOAIN J, LIU J, MOSBERGER L, NISTOR M, DECHSNER H, OLIVEIRA J. V, PATERSON M, PAUSS A, POMMIER S, PORQUEDDU I, RAPOSO F, RIBEIRO T, RÜSCH PFUND F, STRÖMBERG S, TORRIJOS M, VAN EEKERT M, VAN LIER J, WEDWITSCHKA H, WIERINCK I (2016): Towards a standardization of biomethane potential tests. In: *Water Science and Technology*, 74, pp. 2515–2522. doi: 10.2166/wst.2016.336
- HOLLIGER C, FRUTEAU DE LACLOS H, HACK G (2017): Methane production of full-scale anaerobic digestion plants calculated from substrate's biomethane potentials compares well with the one measured on-site. In: *Frontiers in Energy Research*, Vol. 5, No. 12
- HOLMBERG A (1982): On the practical identifiability of microbial growth models incorporating Michaelis-Menten type nonlinearities. In: *Mathematical Biosciences*, Vol. 62, No. 1, pp. 23–43
- HUSON DH, BEIER S, FLADE I, GORSKA A, EL-HADIDI M, MITRA S, RUSCHEWEYH HJ, TAPPU R (2016): MEGAN community edition - Interactive exploration and analysis of large-scale microbiome sequencing data. In: *PLoS Computational Biology*, Vol. 12, No. 6, pp. e1004957
- ILLUMINA (2013): 16S Metagenomic sequencing library preparation (15044223 B). https://support.illumina.com/downloads/16s_metagenomic_sequencing_library_preparation.html, (Ed.) Illumina
- ILLUMINA (2016): Nextera Low Plex Pooling Guidelines. https://www.illumina.com/documents/products/technotes/technote_nextera_low_plex_pooling_guidelines.pdf, (Ed.) Illumina
- ILLUMINA (2018): Nextera XT DNA Library Prep Kit Reference Guide (15031942v03). https://support.illumina.com/content/dam/illumina-support/documents/documentation/chemistry_documentation/samplepreps_nextera/nextera-xt/nextera-xt-library-prep-reference-guide-15031942-03.pdf, (Ed.) Illumina

- ISERMANN R, MÜNCHHOF M (2011): Identification of Dynamic Systems. Springer, Berlin
- ITS (2009): Industrial Tomography Systems Plc.: p2+ Electrical Resistance Tomography System – User´s manual. Manchester
- IPCC (1996): Climate Change 1995: The Science of Climate Change. In: *2nd Assessment Report of the Intergovernmental Panel on Climate Change*, Houghton JT, Meira Filho LG, Callander BA, Harris N, Kattenberg A and Maskell K (Eds.), Cambridge: Cambridge University Press
- IPCC (2001): Climate Change 2001: The Scientific Basis. In: *3rd Assessment Report of the Intergovernmental Panel on Climate Change*, Houghton JT, Ding Y, Griggs DJ, Noguer M, van der Linden PY, Dai X, Maskell K, and Johnson CA (Eds.), Cambridge: Cambridge University Press
- IPCC (2007): Climate Change 2007: The Physical Science Basis. In: *4th Assessment Report of the Intergovernmental Panel on Climate Change*, Solomon S, Qin D, Manning M, Chen Z, Marquis M, Averyt KB, Tignor M and Miller, HL (Eds.), Cambridge: Cambridge University Press
- IPCC (2013): Climate Change 2013: The Physical Science Basis. In: *5th Assessment Report of the Intergovernmental Panel on Climate Change*, Stocker TF, Qin D, Plattner G-K, Tignor M, Allen SK, Boschung J, Nauels A, Xia Y, Bex V and Midgley PM (Eds.), Cambridge: Cambridge University Press
- JANKE HD (2008): Umweltbiotechnik – Grundlagen und Verfahren [Environmental biological engineering – Fundamentals and processes], 2nd ed., Stuttgart: Ulmer Verlag – ISBN 9783825283803
- JANKE L, WEINRICH S, LEITE A F, TERZARIOLA F K, NIKOLAUSZC M, NELLES M, STINNER W (2017): Improving anaerobic digestion of sugarcane straw for methane production: Combined benefits of mechanical and sodium hydroxide pretreatment for process designing. In: *Energy Conversion and Management*. Vol. 141, pp. 378-389
- JANSSEN PHM, HEUBERGER P S C (1996): Calibration of process-oriented models. In: *Ecological Modelling*, Vol. 83, No. 1-2, pp. 55–66
- JENSEN PD, GE H, BATSTONE DJ (2011): Assessing the role of biochemical methane potential tests in determining anaerobic degradability rate and extent. In: *Water Science & Technology*, Vol. 64, No. 4, pp 880–886
- JUSTESEN C G, Astals S, Mortensen J R, Thorsen R, Koch K, Weinrich S, Hafner S D (2019): Development and validation of a low-cost gas density method for measuring biochemical methane potential (BMP). DOI: 10.13140/RG.2.2.28667.77607. www.researchgate.net/publication/333797727_Development_and_validation_of_a_low-cost_gas_density_method_for_measuring_biochemical_methane_potential_BMP
- KALTSCHMITT M, HARTMANN H, HOFBAUER H (Eds) (2016): Energie aus Biomasse – Grundlagen, Techniken und Verfahren [Energy from biomass – Principles, techniques and procedures]. Springer-Verlag, Berlin Heidelberg. 3rd ed. DOI: 10.1007/978-3-662-47438-9
- KÄÄRIÄINEN T, RICHMOND CA, MANNINEN A (2018): Determining biogenic content of biogas by measuring stable isotopologues 12CH₄, 13CH₄, and CH₃D with a mid-infrared direct absorption laser spectrometer. In: *Sensors* 18 (2), 496 pp. 1-10
- KÄSS, W (2004): Lehrbuch der Hydrogeologie Vol. 9 – Geohydrologische Markierungstechnik [Textbook of hydrogeology Vol. 9 – Geohydrological marking technology]. 2nd ed., Berlin: Bornträger Verlag – ISBN 9783443010508
- KEPPLER F, LAUKENMANN S, RINNE J, HEUWINKEL H, GREULE M, WHITICAR M, LELIEVELD J (2010): Measurement of 13C/12C methane from anaerobic digesters: comparison of continuous-flow isotope ratio mass spectrometry and optical spectrometry. In: *Environ. Sci. Technol.* 44 (13), pp. 5067-5073
- KLEYBÖCKER A, LIEBRICH M, VERSTRATE W, KRAUME M, WÜRDEMANN H (2012): Early warning indicators for process failure due to organic overloading by rapeseed oil in one-stage continuously stirred tank reactor, sewage sludge and waste digesters. In: *Bioresource technology* 123, pp. 534–541
- KIELHORN E, SACHSE S, MOENCH-TEGEDER M, NAEGELE H-J, HAELSIG C, OECHSNER H, VONAU W, NEUBAUER P, JUNNE S (2015): Multiposition sensor technology and lance-based sampling for improved monitoring of the liquid phase in biogas processes. In: *Energy & Fuels*, Vol. 29, pp. 4038–4045

- KIM TG, JEONG SY, CHO KS (2015): Development of droplet digital PCR assays for methanogenic taxa and examination of methanogen communities in full-scale anaerobic digesters. In: *Applied Microbiology and Biotechnology*, Vol. 99, No. 1, pp. 445-458
- KLINDWORTH A, PRUESSE E, SCHWEER T, PEPLIES J, QUAST C, HORN M, GLÖCKNER FO (2013): Evaluation of general 16S ribosomal RNA gene PCR primers for classical and next-generation sequencing-based diversity studies. In: *Nucleic Acids Research*, Vol. 41, No. 1, pp. e1
- KLOCKE M (2017): Bioindikatoren der Biogasfermentation - Entwicklung von molekularen Markern und Nachweisverfahren auf Basis der quantitativen PCR für das Monitoring von prozessrelevanten Mikroorganismen als Frühwarnsystem für Prozessstörungen [Bioindicators of biogas fermentation - development of molecular markers and detection methods based on quantitative PCR for the monitoring of process-relevant microorganisms as an early warning system for process disturbances]. Leibniz - Institut für Agrartechnik und Bioökonomie e.V. (ATB)
- KNOCH A (1997): Einfluß des nicht-newtonschen Fließverhaltens auf die charakteristischen Größen eines Rührprozesses [Impact of the non-Newtonian flow behaviour on the characteristic parameters of a stirring process]. In: *Chemie Ingenieur Technik*, Vol. 69, No. 10, pp. 1426-1432
- KOCH K, DREWES JE (2014): Alternative approach to estimate the hydrolysis rate constant of particulate material from batch data. In: *Applied Energy*, Vol. 120, pp. 11-15
- KOCH K, LIPPERT T, DREWES J (2017): The role of inoculum's origin on the methane yield of different substrates in Biochemical Methane Potential (BMP) tests. *Bioresource Technology* 243, 457-463
- KOCH K, HAFNER SD, WEINRICH S AND ASTALS S (2019): Identification of Critical Problems in Biochemical Methane Potential (BMP) Tests From Methane Production Curves. In: *Front. Environ. Sci.* 7:178. DOI: 10.3389/fenvs.2019.00178
- KRAMER O (2017): Genetic Algorithm Essentials. 1. Edt. Springer, Berlin
- KRANERT M, GRAUL S, HILLEBRECHT K (2002a): Entwicklung eines Verfahrens zur Sandgehaltsbestimmung in Bioabfällen und Restmüll, FH Braunschweig, Forschungsbericht unveröffentlicht [Development of a method for the determination of the sand content in bio-wastes and residual waste, University of Applied Sciences Braunschweig, research report unpublished]
- KRANERT M, GRAUL S, HILLEBRECHT K (2002b): Untersuchung zur Bestimmung von Mineralgehalten in Bioabfällen und Gärückständen [Analysis regarding the determination of the mineral contents of bio-wastes and digestates]. In: *Müll und Abfall*, Vol. 02, No. 11, pp. 612-617
- KRAUME M (2004): Transportvorgänge in der Verfahrenstechnik: Grundlagen und apparative Umsetzung [Transport processes in process engineering: Fundamentals and instrumental implementation], 1st ed., Berlin: Springer Verlag - ISBN 978-3-642-18936-4
- KRAUSE P, BOYLE D P, BÄSE F (2005): Comparison of different efficiency criteria for hydrological model assessment. In: *Advances in Geosciences*, Vol. 5, pp. 89-97
- KrWG (2012): Circular Economy Act [Kreislaufwirtschaftsgesetz - KrWG]: Act Reorganising the Law on Closed Cycle Management and Waste (Gesetz zur Neuordnung des Kreislaufwirtschafts- und Abfallrechts) of February 24th 2012
- KTBL (2015): Gasausbeute in landwirtschaftlichen Biogasanlagen [Gas yield in agricultural biogas plants]. 3. Auflage, Heft Nr. 107, Ed. Kuratorium für Technik und Bauwesen in der Landwirtschaft e.V. (KTBL), ISBN 978-3-945088-03-6, Darmstadt
- KTBL (2013): Faustzahlen Biogas [Main figures of biogas]. 3. Auflage, Ed. Kuratorium für Technik und Bauwesen in der Landwirtschaft e.V. (KTBL), ISBN 978-3-941583-85-6, Darmstadt
- KUHN R, BÖLLERMANN J, KRAHL K, BRYANT I M, MARTIENSSSEN M (2017): Comparison of ten different DNA extraction procedures with respect to their suitability for environmental samples. In: *Journal of Microbiological Methods*, Vol. 143, Spp. 78-86. DOI: 10.1016/j.mimet.2017.10.007
- KYTHREOTOU N, FLORIDES G, TASSOU S A (2014): A review of simple to scientific models for anaerobic digestion. In: *Renewable Energy*, Vol. 71, No. 701-714

- LaVISION (2014): Particle Image Velocimetry (PIV). www.lavision.de/de/techniques/piv.php
- LEBUHN M, DERENKÓ J, RADEMACHER A, HELBIG S, MUNK B, PECHTL A, STOLZE Y, PROWE S, SCHWARZ W, SCHLÜTER A, LIEBL W, KLOCKE M (2016): DNA and RNA extraction and quantitative real-time PCR-based assays for biogas biocenoses in an interlaboratory comparison. In: *Bioengineering*, Vol. 3, No. 1, pp. 7
- LEE QF (2009): Electrical Resistance Tomography (ERT). Advanced Chemical Technology Centre. [Cross-reference: Presentation from 2009: www.chmtech.com/ert/ert.pps]
- LEITHOLD G, HÜLSBERGEN KJ (1998): Humusbilanzierung im ökologischen Landbau [Humus balancing in ecological farming]. In: *Ökologie und Landbau*, Vol. 105, pp. 32–35
- LERM S, KLEYBÖCKER A, MIETHLING-GRAFF R, VIETH-HILLEBRAND A, ALAWI M, KASINA M, LIEBRICH M, WÜRDEMANN H (2012): Archaeal community composition affects the function of anaerobic co-digesters in response to organic overload. In: *Waste Management*, Vol. 32, No. 3, pp. 389–399
- LESTEUR M, BELLON-MAUREL V, GONZALEZ C, LATRILLE E, ROGER J M, JUNQUA G, STEYER J P (2010): Alternative methods for determining anaerobic biodegradability: a review. In: *Process Biochemistry*, Vol. 45, No. 4, pp. 431–440
- LEVENSPIEL O (1962): Chemical Reaction Engineering, New York: Wiley and Sons Li BW & ANDREWS KW (1986): Separation of trimethylsilylated oximes of monosaccharides by capillary gas-liquid chromatography. In: *Chromatographia*, Vol. 21, No. 10, S. 596–598
- LIEBETRAU J, STRACH K, SCHNEIDER M (2011): Anaerobe Behandlung von Hühnerkot – prozessbiologische und stoffliche Randbedingungen [Anaerobic treatment of chicken droppings – process-biological and material framework conditions]. In: *Biogas aus Abfällen und Reststoffen*, Vol. 81., pp. 137–146, Dresden: Eigenverlag des Forums für Abfallwirtschaft und Altlasten – ISBN 978-3-934253-73-5
- LIEBETRAU J, REINELT T, AGOSTINI A, LINKE B (2017): Methane emissions from biogas plants. Methods for measurement, results and effect on greenhouse gas balance of electricity produced. Jerry D. Murphy (Ed.). IEA Bioenergy Task 37. http://task37.ieabioenergy.com/files/daten-redaktion/download/Technical%20Brochures/Methane%20Emission_web_end_small.pdf, checked on 1/17/2018
- LOMAS CG (1986): Fundamentals of hot wire anemometry. 1st ed., Cambridge: Cambridge University Press
- LÖMBRISER R, ABPLANALP PA (1998): Strategisches Management: Visionen entwickeln, Strategien umsetzen, Erfolgspotentiale aufbauen [Strategic management: developing visions, implementing strategies, creating success potentials]. 2nd ed., Zürich: Versus Verlag – ISBN 9783908143598
- LV Z, HU M, HARMS H, RICHNOW HH, LIEBETRAU J, NIKOLAUSZ M (2014): Stable isotope composition of biogas allows early warning of complete process failure as a result of ammonia inhibition in anaerobic digesters. In: *Bioresour. Technol.* 167 (September 2014), pp. 251–259
- LYBERATOS G, SKIADAS I V (1999): Modelling of anaerobic digestion – A review. In: *Global NEST Journal*, Vol. 1, No. 2, pp. 63–76
- MALKIN A Y, ISAYEV A I (2005): Rheology: Concepts, Methods, And Applications. Canada: Chem Tec Publishing – ISBN 978-1895198331
- MATA-ÁLVAREZ J (2003): Fundamentals of the Anaerobic Digestion Process. In: MATA-ÁLVAREZ, J (Ed.): Biomechanization of the Organic Fraction of Municipal Solid Wastes. IWA Publishing, London, pp. 1–20
- MAY T, KOCH-SINGENSTREU M, EBLING J, STANTSCHOFF R, MÜLLER L, JACOBI F, POLAG D, KEPPLER F, KONIG H (2015): Design and application of a synthetic DNA standard for real-time PCR analysis of microbial communities in a biogas digester. In: *Applied Microbiology and Biotechnology*, Vol. 99, No. 16, pp. 6855–6863
- MCCARTY PL (1972): Energetics of organic matter degradation. In: *Water Pollution Microbiology*, Mitchell R (Ed.), pp. 91–118, New York: Wiley & Sons
- MCGINN S M, FLESCH T K, HARPER L A, BEAUCHEMIN K A (2006): An Approach for Measuring Methane Emissions from Whole Farms. In: *Journal of Environment Quality*, Vol. 35, No. 1, p. 14–20

- McLROY SJ, SAUNDERS AM, ALBERTSEN M, NIERYCHLO M, McLROY B, HANSEN AA, KARST SM, NIELSEN JL, NIELSEN PH (2015): MIDAS: the field guide to the microbes of activated sludge. In: *Database-the Journal of Biological Databases and Curation*, Vol. bav062, pp. 1-8
- McMANUS JB, ZAHNISR MS, NELSON DD, WILLIAMS LR, KOLB CE (2002): Infrared laser spectrometer with balanced absorption for measurement of isotopic ratios of carbon gases. In: *Spectrochim. Acta A Mol. Biomol. Spectrosc.* 58 (11), pp. 2465-2479
- MEITZNER AB & OTTO RE (1957): Agitation of non-Newtonian fluids. In: *AIChE Journal*, Vol. 3, No. 1, pp. 3-10
- MEZGER T (2006): *Das Rheologie Handbuch [The Rheology Handbook]*. 2nd ed., Hannover: Vincentz Network Verlag – ISBN 3-87870-175-6
- MOELLER L & GÖRSCH K (2015a): Foam formation in full-scale biogas plants processing biogenic waste. In: *Energy, Sustainability and Society*, Vol. 5, No. 1
- MOELLER L, EISMANN F, WISSMANN D, NÄGELE HJ, ZIELONKA S, MÜLLER RA, ZEHNSDORF A (2015b): Innovative test method for the estimation of the foaming tendency of substrates for biogas plants. In: *Waste Management*, Vol. 41, pp. 39-49
- MONTEITH, H.; STEPHENSON, J.: Mixing efficiencies in full-scale anaerobic digesters by tracer methods. In: *Journal Water Pollution Control Federation* Vol. 53 (1981), No. 1, Pg. 78-84
- MORIASI D N, ARNOLD J G, VAN LIEW M W, BINGNER R L, HARMEL R D, VEITH T L (2007): Model Evaluation Guidelines for Systematic Quantification of Accuracy in Watershed Simulations. In: *Transactions of the American Society of Agricultural and Biological Engineers*, Vol. 50, No. 3, pp. 885-900
- MOSHAGE U (2004): *Rheologie kommunaler Klärschlämme. Messmethoden und Praxisrelevanz [Rheology of communal sewage sludges. Measurement methods and practical relevance]*. Dissertation at Institut für Siedlungswasserwirtschaft, TU Braunschweig, Heft 72
- MULAT DG, JACOBI F, FEILBERG A, ADAMSEN AP, RICHNOW HH, NIKOLAUS M (2016): Changing feeding regimes to demonstrate flexible biogas production: Effects on process performance, microbial community structure, and methanogenesis pathways. In: *Appl. Environ. Microbiol.* 82 (2), pp. 438-449
- MÜLLER J, TIEHM A, EDER B, GÜNTHER W, HRUSCHKA H, KOPP J, KUNZ PM, OTTE-WITTE R, SCHMELZ KG, SEILER K (2000): Verfahren und Anwendungsgebiete der mechanischen Klärschlamm-Desintegration [Procedures and application fields of mechanical sewage sludge disintegration]. In: *KA - Wasserwirtschaft, Abwasser, Abfall*, Vol. 47, No. 4, pp. 570-576
- MUKENGELE M & OECHSNER H (2007): Einfluss der Silierung auf den spezifischen Methanertrag bei Mais [Impact of silaging on the specific methane yield of maize]. In: *Landtechnik*, Vol. 62, No. 1, pp. 20-21
- MUMY KL, FINDLAY H (2004): Convenient determination of DNA extraction efficiency using an external DNA recovery standard and quantitative-competitive PCR. In: *Journal of Microbiological Methods*, Vol. 57, No. 2, pp. 259-268
- MUNK B, BAUER C, GRONAUER A, LEBUHN M (2012): A metabolic quotient for methanogenic Archaea. In: *Water Science and Technology*, Vol. 66, No. 11, pp. 2311-2317
- MUNK B, GÜBIT, GM, LEBUHN M (2017): Influence of nitrogen-rich substrates on biogas production and on the methanogenic community under mesophilic and thermophilic conditions. In: *Anaerobe*, Vol. 46, pp. 146-154
- MURNLEITNER E (2001): State Detection and Feedback Control of the Anaerobic Wastewater Treatment Using Fuzzy Logic. Series 15, number 237 of the "VDI Fortschrittsberichte" (VDI proceedings) by VDI Verlag, Düsseldorf. ISBN 3-18-323715-6. <https://mediatum.ub.tum.de/doc/603312/603312.pdf>
- NaRoBi (2010): Abschlussbericht Verbundvorhaben „Bewertung nachwachsender Rohstoffe zur Biogaserzeugung für die Pflanzenzüchtung“; Teilvorhaben 3: Biogaserträge in Laborversuchen - Fragen zur Vergleichbarkeit und Übertragbarkeit; FKZ: 22019205 [Final report joint project "Evaluation of renewable raw materials for biogas production for plant breeding"; Subproject 3: Biogas yields in laboratory tests - questions of comparability and transferability]. www.fnr-server.de/ftp/pdf/berichte/22019205.pdf

- NIHTILÄ M, VIRKKUNEN J (1977): Practical identifiability of growth and substrate consumption models. In: *Biotechnology and Bioengineering*, Vol. 19, No 12, pp. 1831–1850
- NIKOLAUSZ M, WALTER RFH, STRÄUBER H, LIEBETRAU J, SCHMIDT T, KLEINSTEUBER S, BRATFISCH F, GÜNTHER U, RICHNOW HH (2013): Evaluation of stable isotope fingerprinting techniques for the assessment of the pre-dominant methanogenic pathways in anaerobic digesters. In: *Appl. Microbiol. Biotechnol.* 97 (5), pp. 2251-2262
- NIST Chemistry WebBook, National Institute of Standards and Technology, U.S. Department of Commerce, 100 Bureau Drive, Gaithersburg, MD 20899. <https://webbook.nist.gov>
- NIISCHE W, BRUNN A (2006): Strömungsmesstechnik [Flow measurement engineering], 2nd ed., Berlin: Springer Verlag – ISBN 978-3-540-20990-4
- NOCEDAL J, WRIGHT S J (2006): Numerical Optimization. 2. Edt., Springer, Berlin
- NURK S, MELESHKO D, KOROBAYNIKOV A, PEVZNER P. A. (2017). metaSPAdes: a new versatile metagenomic assembler. In: *Genome research*, 27(5), 824–834. DOI: <https://doi.org/10.1101/gr.213959.116>
- OECHSNER H & PATERSON M (2013): Methanertrag aus Biomasse – Übertragbarkeit von Laborergebnissen auf die Praxis [Methane yield from biomass - transferability of laboratory results to practice]. In: *Tagungsband „Biogas in der Landwirtschaft – Stand und Perspektiven“*, FNR/KTBL-Kongress vom 10. bis 11. September 2013, Kassel, Ed. Kuratorium für Technik und Bauwesen in der Landwirtschaft e.V. (KTBL), ISBN 978-3-941583-82-5, Darmstadt
- OLIVIER F, GOURC J P (2007): Hydro-mechanical behaviour of municipal solid waste subject to leachate recirculation in a large-scale compression reactor cell. In: *Waste Manage.* 2007, 27 (1), 44–58. DOI: 10.1016/j.wasman.2006.01.025
- OKSANEN J, BLANCHET FG, KINDT R, LEGENDRE P, MINCHIN PR, O'HARA RB, SIMPSON GL, SOLYMO S P, HENRY M, STEVENS H, WAGNER H (2016): Multivariate analysis of ecological communities in R: Vegan tutorial, Vol. 2016. <http://cc.oulu.fi/~jarioksa/opetus/metodi/vegantutor.pdf>
- OLDHAM AL, DUNCAN KE (2012): Similar gene estimates from circular and linear standards in quantitative PCR analyses using the prokaryotic 16S rRNA gene as a model. In: *PLOS One*, Vol. 7, No. 12, pp. e51931
- PANAGIOTOU G (2003): Bringing SWOT into Focus. In: *Business Strategy Review*, Vol. 14, No. 2, pp. 8–10
- PAUSS A, ANDRE G, PERRIER M, GUIOT, SR (1990): Liquid-to-Gas Mass Transfer in Anaerobic Processes: Inevitable Transfer Limitations of Methane and Hydrogen in the Biomethanation Process. In: *Applied and Environmental Microbiology*, Vol. 56, No. 6, pp. 1636–1644
- PAVLOSTATHIS S G & GIRALDO-GOMEZ E (1991): Kinetics of anaerobic treatment: A critical review. In: *Critical Reviews in Environmental Control*, Vol. 21, No. 5–6, pp. 411–490
- PAWLOWSKI J (2004): Prozessbeziehungen bei nichtnewtonschen Stoffen – Kritik des Metzner-Otto-Konzeptes [Process relations of non-newtonian substances – critique of the Metzner-Otto-concept]. In: *Chemie Ingenieur Technik* Vol. 76, No. 7, S. 910–914
- PENG Y, LEUNG HCM, YIU SM, CHIN FYL (2012): IDBA-UD: A de novo assembler for single-cell and metagenomic sequencing data with highly uneven depth. In: *Bioinformatics*, Vol. 28, No. 11, pp. 1420-1428
- POCKLINGTON WD (1991): Precision and accuracy of analysis: Standardisation of analytical methods. In: J.B. Rossell and J.L.R. Pritchard: *Analysis of Oilseeds, Fats and Fatty Foods*. Elsevier Science Publishers, Barking, UK. pp. 1-38
- POLAG D, MAY T, MÜLLER L, KÖNIG H, JACOBI F, LAUKENMANN S, KEPPLER F (2015): Online monitoring of stable carbon isotopes of methane in anaerobic digestion as a new tool for early warning of process instability. In: *Bioresour. Technol.* 197 (December 2015), pp. 161-170
- POPP D, SCHRADER S, KLEINSTEUBER S, HARMS H, STRÄUBER H (2015): Biogas production from coumarin-rich plants-inhibition by coumarin and recovery by adaptation of the bacterial community. In: *Fems Microbiology Ecology*, Vol. 91, No. 9, pp. 9
- QUINCE C, WALKER AW, SIMPSON JT, LOMAN NJ, SEGATA N (2017): Shotgun metagenomics, from sampling to analysis. In: *Nature Biotechnology*, Vol. 35, No. 9, pp. 833-844

- RAPOSO F, FERNANDEZ-CEGRÍ V, DE LA RUBIA MA, BORJA R, BELINE R, CAVINATO C, DEMIRER G, FERNANDEZ B, FERNANDEZ-POLANCO M, FRIGON JC, GANESH R, KAPARAJU P, KOUBOVA J, MENDEZ R, MENIN G, PEENE A, SCHERER P, TORRIJOS M, UELLENDahl H, WIERINCK I, DE WILDEP V (2011): Biochemical methane potential (BMP) of solid organic substrates: evaluation of anaerobic biodegradability using data from an international interlaboratory study. In: *J. Chem. Technol. Biotechnol.* 86, pp. 1088–1098. doi:10.1002/jctb.2622
- RAPOSO F, DE LA RUBIA, M A, FERNÁNDEZ-CEGRÍ V, BORJA R (2012): Anaerobic digestion of solid organic substrates in batch mode: An overview relating to methane yields and experimental procedures. In: *Renewable and Sustainable Energy Reviews*, Vol. 16, No. 1, pp. 861–877
- REINELT T (2017a): Messtechnische Überwachung diffuser, betriebsbedingter und/oder zeitlich variabler Methanemissionen aus Biogasanlagen. In: *Kuratorium für Technik und Bauwesen in der Landwirtschaft (Ed.): Biogas in der Landwirtschaft - Stand und Perspektiven. FNR/KTBL-Kongress vom 26. bis 27. September 2017 in Bayreuth (KTBL-Schrift, 512)*, pp. 237–249
- REINELT T (2017b): Monitoring of operational methane emissions from pressure relief valves of agricultural biogas plants. [Metrological monitoring of diffuse, operation-related and/or time-variable methane emissions from biogas plants] In: *Jan Liebetrau, Daniela Thrän, Diana Pfeiffer (Eds.): III. Conference on Monitoring & Process Control of Anaerobic Digestion Plants. March 29-30, 2017 in Leipzig, Germany (Reader des Förderprogramms für energetische Biomassennutzung)*, pp. 26–27.
- REINELT T, LIEBETRAU J, NELLES M (2016): Analysis of operational methane emissions from pressure relief valves from biogas storages of biogas plants. In: *Bioresource technology* 217, pp. 257–264. DOI: 10.1016/j.biortech.2016.02.073
- RICHARDS BK, CUMMINGS RJ, WHITE TE, JEWELL WJ (1991): Methods for kinetic-analysis of methane fermentation in high solids biomass digesters. In: *Biomass & Bioenergy* 1, pp. 65–73
- RITTMANN BE, KRAJMALNIK-BROWN R, HALDEN RU (2008): Pre-genomic, genomic and post-genomic study of microbial communities involved in bioenergy. In: *Nature Reviews Microbiology*, Vol. 6, No. 8, pp. 604–612
- ROSS RD & ELLIS LM (1992): Laboratory – scale investigation of foaming in anaerobic digesters. *Water Environment Research*, Vol. 64, No. 2, pp. 154–162
- RUIJTER JM, RAMAKERS C, HOOGAARS WMH, KARLEN Y, BAKKER O, VAN DEN HOFF MJB, MOORMAN AFM (2009): Amplification efficiency: linking baseline and bias in the analysis of quantitative PCR data. In: *Nucleic Acids Research*, Vol. 37, No. 6, pp. e45
- RUILE S, SCHMITZ S, MÖNCH-TEGEDER M, OECHSNER H (2015): Degradation efficiency of agricultural biogas plants - A full-scale study. In: *Bioresource Technology*, 178, pp. 341–349. DOI: 10.1016/j.biortech.2014.10.053
- SACHSE S, BOCKISCH A, ENSELEIT U, GERLACH F, AHLBORN K, KUHNKE T, ROTHER U, KIELHORN E, NEUBAUER P, JUNNE S., VONAU W (2015): On the use of electrochemical multi-sensors in biologically charged media. In: *Journal of Sensors and Sensor Systems*, Vol. 4, No. 2, pp. 295–303
- SALTELLI A, RATTO M, TARANTOLA S, CAMPOLONGO F (2005): Sensitivity Analysis for Chemical Models. In: *Chemical Reviews*, Vol. 105, No. 7, pp. 2811–2827
- SANDERS W T M, GEERINK M, ZEEMAN G, LETTINGA G (2000): Anaerobic hydrolysis kinetics of particulate substrates. In: *Water Science Technology*. Vol. 41, pp. 17–24
- SANDERS W T M (2001): Anaerobic hydrolysis during digestion of complex substrates. Wageningen University, Dissertation
- SCHAEFFER F & SCHACHTSCHABEL P: Lehrbuch der Bodenkunde [Textbook of soil science]. 15th ed., Berlin: Spektrum Akademischer Verlag – ISBN 3-8274-1324-9
- SCHELTER M, ZOSEL J, BERTHOLD F, OELSSNER W, GUTH U (2011): Measurement of Dissolved Gases in Anaerobic Biogenic Media. In: *Proceedings SENSOR 2011*, pp. 654–658 – ISBN 978-3-9810993-9-3
- SCHLOSS PD, WESTCOTT SL, RYABIN T, HALL JR, HARTMANN M, HOLLISTER EB, LESNIEWSKI RA, OAKLEY BB, PARKS DH, ROBINSON CJ, SAHL JW, STRES B, THALLINGER GG, VAN HORN DJ, WEBER CF (2009): Introducing mothur: Open-source, platform-independent, community-supported software for describing and comparing microbial communities. In: *Applied and Environmental Microbiology*, Vol. 75, No. 23, pp. 7537–7541

- SCHNEIDER M (2010): Limitierungen bei der Vergärung von Hühnertrockenkot als Monosubstrat [Limitations in the fermenting of dry chicken droppings as mono substrate], Bachelor's Thesis at HTWK Leipzig [Leipzig University of Applied Sciences]
- SCHRÖDER P (2018): Entwicklung eines Frühwarnsystems zur Steigerung der Raum-Zeit-Ausbeute einstufiger NawaRo-Biogasanlagen durch Additivzugabe [Development of an early warning system to increase the space-time yield of single-stage biogas plants for renewable raw materials by adding additives], <http://dx.doi.org/10.14279/depositonce-7655>
- SCHÜRMMANN G (2007): Inverse Ausbreitungsmodellierung zur Emissionsratenbestimmung heterogener Flächenquellen [Inverse dispersion modeling for emission release evaluation of heterogeneous diffuse sources]. Dissertation an der Universität Augsburg, 2007
- SHEWANI A, HORGUE P, POMMIER P, DEBENEST G, LEFEBVRE X, GANDON E, PAUL E (2015): Assessment of percolation through a solid leach bed in dry batch anaerobic digestion processes. In: *Bioresource Technol.* 2015, 178 (2), 209–216. DOI: 10.1016/j.biortech.2014.10.017
- SMITH CJ, OSBORN AM (2009): Advantages and limitations of quantitative PCR (Q-PCR)-based approaches in microbial ecology. In: *FEMS Microbiology Ecology*, Vol. 67, No. 1, pp. 6-20
- SONNTAG D (1990): Important new Values of the Physical Constants of 1986, Vapour Pressure Formulations based on ITS-90 and Psychrometer Formulae. In: *Z. Meteorol.* (40), pp. 340–344
- Spektrum (2001): Kompaktlexikon der Biologie. Springer Spektrum. ISBN 978-3-8274-3067-0
- STEINBERG LM, REGAN JM (2008): Phylogenetic comparison of the methanogenic communities from an acidic, oligotrophic fen and an anaerobic digester treating municipal wastewater sludge. In: *Applied and Environmental Microbiology*, Vol. 74, No. 21, pp. 6663-6671
- STRÄUBER H, LUCAS R, KLEINSTEUBER S (2016): Metabolic and microbial community dynamics during the anaerobic digestion of maize silage in a two-phase process. In: *Applied Microbiology and Biotechnology*, Vol. 100, No. 1, pp. 479-491
- STRÖMBERG S, NISTOR M, LIU J (2015): Early prediction of Biochemical Methane Potential through statistical and kinetic modelling of initial gas production. In: *Bioresource Technology*, Vol. 176, pp. 233–241
- STRUBELT C (2013): Mündliche Mitteilung [Oral communication] 14.10.2013
- STUR M, KREBS C, MAUKY E, OEHMICHEN K, MURNLEITNER E (2018): ManBio – Entwicklung von technischen Maßnahmen zur Verbesserung des Gasmanagements von Biogasanlagen. Gemeinsamer Schlussbericht gemäß Anlage 2 (zu Nr. 8.2 NKBF 98) für den Zeitraum von 01.09.2014 bis 28.02.2017 [ManBio - Development of technical measures to improve the gas management of biogas plants]. www.energetische-biomassennutzung.de/fileadmin/Steckbriefe/dokumente/03K-B094AB_Schlu%C3%9Fbericht_ManBio_4.pdf
- TA LUFT (2002): Technische Anleitung zur Reinhaltung der Luft [Technical Instructions on Air Quality Control] – 1. Allgemeine Verwaltungsvorschrift zum Bundes-Immissionsschutzgesetz, In: 4. *BImSchV [Federal Emissions Protection Act]*
- THEUERL S, KOHRS F, BENNDOR D, MAUS I, WIBBERG D, SCHLUTER A, KAUSMANN R, HEIERMANN M, RAPP E, REICHL U, PUHLER A, KLOCKE M (2015): Community shifts in a well-operating agricultural biogas plant: how process variations are handled by the microbiome. In: *Applied Microbiology and Biotechnology*, Vol. 99, No. 18, pp. 7791-7803
- THOMAS T, GILBERT J, MEYER F (2012): Metagenomics - A guide from sampling to data analysis. In: *Microbial Informatics and Experimentation*, Vol. 2, No. 3, pp. 1-12
- TENNEY M & BUDZIN G (1972): How good is your mixing? In: *Water and Wastes Engineering*, Vol. 9, No. 5, pp. 57–59
- TÜRCK M (1987): Zum Fließverhalten von Güllemischungen [Regarding the flow behaviour of liquid manure mixtures]. In: *Agrartechnik*, Vol. 37, No. 2
- TURANYI T (1990): Sensitivity Analysis of Complex Kinetic Systems: Tools and Application. In: *Journal of Mathematical Chemistry*, Vol. 5, pp. 203–248

- UMWELTBUNDESAMT [FEDERAL ENVIRONMENTAL AGENCY] (2008): Bodenschutz beim Anbau nachwachsender Rohstoffe [Soil conservation in the cultivation of renewable resources], Dessau-Roßlau
- VDI 2469 Blatt 1 (2005): VDI-Richtlinie 2469 Blatt 1 Messen gasförmiger Emissionen – Messen von Distickstoffmonoxid – Manuelles gaschromatographisches Verfahren [Guideline Determination of gaseous emissions – Measurement of nitrous oxide – Manual gas chromatographic method]. Düsseldorf: Beuth Verlag
- VDI 3469 Blatt 1 (2007): VDI-Richtlinie 3469 Blatt 1 Emissionsminderung – Herstellung und Verarbeitung von faserhaltigen Materialien – Faserförmige Stäube – Grundlagen, Überblick [Guideline Reduction of emissions – Production and processing of fibrous materials – Fibrous dusts – Basics, overview]. Düsseldorf: Beuth Verlag
- VDI 3475 Blatt 4 (2010): VDI-Richtlinie 3475 Blatt 4 Emissionsminderung – Biogasanlagen in der Landwirtschaft – Vergärung von Energiepflanzen und Wirtschaftsdünger [Guideline VDI 3475 Part 4 Reduction of emissions – Biogas plants in agriculture – Fermentation of energy crops and farm manure]. Düsseldorf: Beuth Verlag
- VDI 3475 (2010): Guideline VDI 3475 Emission control - Agricultural biogas facilities; Digestion of energy crops and manure, in: VDI/DIN manual Air Pollution Prevention, Vol. 3: Emission Control (continued) [VDI-Richtlinie 3475 Emissionsminderung Biogasanlagen in der Landwirtschaft, Vergärung von Energiepflanzen und Wirtschaftsdüng/DIN-Handbuch Reinhaltung der Luft, Band 3: Emissionsminderung II], Section 4.3.4, pp. 51. Düsseldorf: Verein Deutscher Ingenieure e.V., Beuth Verlag
- VDI 3481 Blatt 3 (1995): VDI-Richtlinie 3481 Blatt 3 Messen gasförmiger Emissionen – Messen von flüchtigen organischen Verbindungen, insbesondere von Lösungsmitteln, mit dem Flammen-Ionisations-Detektor [Guideline VDI 3481 Part 3 Determination of gaseous emissions – Measurement of volatile organic compounds, particularly of solvents, by flame ionization detector]. Düsseldorf: Beuth Verlag
- VDI 3481 Blatt 4 (2007): VDI-Richtlinie 3481 Blatt 4 Messen gasförmiger Emissionen – Messen der Konzentrationen von Gesamt-C und Methan-C mit dem Flammenionisationsdetektor [Guideline VDI 3481 Part 4 Determination of gaseous emissions – Measurement of overall-C and methane-C concentrations by flame ionization detector]. Düsseldorf: Beuth Verlag
- VDI 3945 Blatt 3 (2000): VDI-Richtlinie 3945 Blatt 3 Umweltmeteorologie – Atmosphärische Ausbreitungsmodelle – Partikelmodell [Guideline VDI 3945 Part 3 Environmental meteorology – Atmospheric dispersion models – Particle model]. Düsseldorf: Beuth Verlag
- VDI 4285 Blatt 1 (2005): VDI-Richtlinie 4285 Blatt 1 Messtechnische Bestimmung der Emissionen diffuser Quellen – Grundlagen [Guideline VDI 4285 Part 1 Metrological determination of emissions from diffuse sources – Basics]. Düsseldorf: Beuth Verlag
- VDI 4630 (2016): VDI-Richtlinie 4630 Vergärung organischer Stoffe – Substratcharakterisierung, Probenahme, Stoffdatenerhebung, Gärversuche [Guideline VDI 4630 Fermentation of organic substances – substrate characterisation, sampling, data collection, fermentation tests]. Düsseldorf: Beuth Verlag
- VDLUFÄ (1988): Methodenhandbuch Band III – Die chemische Untersuchung von Futtermitteln [Method Handbook Vol. III – The chemical analysis of feedstuffs]. 3rd ed., Darmstadt – ISBN 978-3-941273-14-6
- VDLUFÄ (2004): Humusbilanzierung – Methode zur Beurteilung und Bemessung der Humusversorgung von Ackerland [Method for the assessment and sizing of the humus supply for arable land]. Bonn
- VDLUFÄ (2011): Measurement of Biogas and Methane Yields in Fermentation Tests. VDLUFÄ Association Method. Band VII. Darmstadt, Germany.
- VDLUFÄ (2011): Measurement of biogas and methane yields in fermentation tests. VDLUFÄ Association Method, VDLUFÄ-Method book, Vol VII, Environmental Analysis, Method 4.1.1, Ed. Verbands deutscher landwirtschaftlicher Untersuchungs- und Forschungsanstalten e.V., ISBN 978-3-941273-10-8, VDLUFÄ-Verlag, Darmstadt

- VDLUFA AND KTBL (2017): Evaluation report of KTBL/VDLUFA-Proficiency Test Biogas 2016. Ed. VDLUFA Qualitätssicherung NIRS GmbH und Kuratorium für Technik und Bauwesen in der Landwirtschaft e.V., 2017, Kassel and Darmstadt, unpublished
- VDLUFA (2019): Determination of residual gas potential from fermentation residues in laboratory tests. VDLUFA Association Method, VDLUFA-Method book, Vol VII, Environmental Analysis, Method 4.1.2, Ed. Verbands deutscher landwirtschaftlicher Untersuchungs- und Forschungsanstalten e.V., VDLUFA-Verlag, Darmstadt
- VESALA T, KLJUN N, RANNIK Ü, RINNEN J, SOGACHEV A, MARKKANEN T, SABELFELD K, FOKEN TH, LECLERC MY (2008): Flux and Concentration Footprint Modelling: State of the Art. In: *Environmental Pollution*, Vol. 152, pp. 653–666
- WAGNER AO, LINS P, ILLMER P (2012): A simple method for the enumeration of methanogens by most probable number counting. In: *Biomass and Bioenergy*, Vol. 45, pp. 311–314
- WAGNER A O, MALIN C, KNAPP B A, ILLMER P (2008): Removal of free extracellular DNA from environmental samples by ethidium monoazide and propidium monoazide. In: *Applied and Environmental Microbiology*, Vol. 74 (8), Spp. 2537–2539. DOI: 10.1128/AEM.02288-07
- WANG Y, ZHANG Y, WANG J, MENG L (2009): Effects of volatile fatty acid concentrations on methane yield and methanogenic bacteria. In: *Biomass and Bioenergy*, Vol. 33, No. 5, pp. 848–853
- WALTER E, PRONZATO L (1997): Identification of Parametric Models from experimental Data. Springer, Berlin
- WARD A J, FENG L, MOSET V, MOLLER H B (2018): Estimation of Methane Yields in Continuous Biogas Reactors Using Kinetic and Mass Flow Models. In: *Chemical Engineering and Technology*, Vol. 41, No. 4, pp. 761–767
- WEDWITSCHKA H, JENSON E, LIEBETRAU J (2016): Feedstock Characterization and Suitability Assessment for Dry Anaerobic Batch Digestion. In: *Chemical Engineering & Technology*. Bd. 39 (Nr. 4). pp. 665–672. doi: 10.1002/ceat.201500413
- WEILAND P (2001): Grundlagen der Methangärung – Biologie und Substrate [Basics of methane fermentation – biology and substrates]. In: *Biogas als regenerative Energie – Stand und Perspektiven (VDI-Bericht)*, No. 1620, Düsseldorf: VDI Verlag
- WEILAND P (2008): Wichtige Messdaten für den Prozessablauf und Stand der Technik in der Praxis. In: *Messen, Steuern, Regeln bei der Biogaserzeugung*. [Important measurement data for the process flow and state of the art in practice. In: *Measurement, control and regulation in biogas production*] FNR, Gülzow, pp. 17–31
- WEILAND P (2010): Biogas production: current state and perspectives. In: *Applied Microbiology and Biotechnology*, vol. 85, No. 4, pp. 849–860
- WEINRICH S, WEISSBACH F, PRÖTER J, LIEBETRAU J, NELLES M (2014): Massenbilanzierung von Biogasanlagen: Möglichkeiten und Herausforderungen zur Effizienzbewertung von Biogasanlagen [Mass balancing of biogas plants: Opportunities and challenges for efficiency determination of biogas plants]. In: *Tagungsband 8. Rostocker Bioenergieforum*, pp. 369–379 – ISBN 978-3-86009-412-9
- WEINRICH S (2017): Practical Simulation of Biogas Plants – Systematic Simplification of the Anaerobic Digestion Model No. 1 (ADM1). Dissertaion, University of Rostock (in German)
- WEINRICH S., PATERSON M (2017): Aussagekraft von diskontinuierlichen Laborversuchen (Batchtests) zur Substrat- und Prozessbewertung von Biogasanlagen [Significance of discontinuous laboratory tests (batch tests) for substrate and process evaluation of biogas plants]. In: *Tagungsband „Biogas in der Landwirtschaft – Stand und Perspektiven“*, FNR/KTBL-Kongress vom 26. bis 27. September 2017, Bayreuth, Ed. Kuratorium für Technik und Bauwesen in der Landwirtschaft e.V. (KTBL), ISBN 978-3-945088-52-4, Darmstadt
- WEINRICH S, PRÖTER J (2017): Parameter estimation in anaerobic digestion: Critical evaluation of different experimental setups and model structures. In: *LIEBETRAU J, THRÄN D, PFEIFFER, D (Ed.): Conference Proceedings of the 3rd International Conference on Monitoring and Process Control of Anaerobic Digestion Plants*. Leipzig, pp. 44–45

- WEINRICH S, SCHÄFER F, BOCHMANN G, LIEBETRAU J (2018): Value of batch tests for biogas potential analysis; method comparison and challenges of substrate and efficiency evaluation of biogas plants. Murphy J.D. (Ed.), IEA Bioenergy Task 37(10)
- WEISS A, JÉRÔME V, FREITAG R (2007): Comparison of strategies for the isolation of PCR-compatible, genomic DNA from a municipal biogas plants. In: *Journal of Chromatography B*, Vol. 853, No. 1–2, pp. 190–197
- WEISSBACH F (2008): Zur Bewertung des Gasbildungspotenzials von nachwachsenden Rohstoffen. In: *Landtechnik*, Vol. 63, No. 6, S. 356–358
- WEISSBACH F (2009): Die Bewertung von nachwachsenden Rohstoffen für die Biogasgewinnung – Teil I: Das Gasbildungspotenzial der fermentierbaren Nährstoffe [Determination of renewable feedstocks for biogas generation, Part 1] In: *Pflanzenbauwissenschaften*, Vol. 13, No. 2, pp. 72–85 – ISSN 1431-8857
- WEISSBACH F (2011): The future of forage conservation. In: *Proceedings II International Symposium on Forage Quality and Conservation*. Sao Pedro, Brazil, pp. 319–363
- WEISSBACH F & KUHLA S (1995): Stoffverluste bei der Bestimmung des Trockenmassegehaltes von Silagen und Grünfütter: Entstehende Fehler und Möglichkeiten der Korrektur. [Material losses in the determination of the dry matter content of silage and soilage] In: *Übersichten Tierernährung*, Vol. 23, pp. 189–214
- WEISSBACH F & STRUBELT C (2008a): Die Korrektur des Trockensubstanzgehaltes von Maissilagen als Substrat für Biogasanlagen [The correction of the total solids content of maize silages as substrate for biogas plants]. In: *Landtechnik*, Vol. 63, No. 2, pp. 82–83
- WEISSBACH F & STRUBELT C (2008b): Die Korrektur des Trockensubstanzgehaltes von Grassilagen als Substrat für Biogasanlagen [The correction of the total solids content of grass silages as substrate for biogas plants]. In: *Landtechnik*, Vol. 63, No. 4, pp. 210–211
- WEISSBACH F & STRUBELT C (2008c): Die Korrektur des Trockensubstanzgehaltes von Zuckerrübensilagen als Substrat für Biogasanlagen [The correction of the total solids content of sugar-beet silages as substrate for biogas plants]. In: *Landtechnik*, Vol. 63, No. 6, pp. 354–355
- WHITE K (1974): The use of radioactive tracers to study mixing and residence-time distributions in systems exhibiting three-dimensional dispersion. In: *1st European Conference on Mixing and Centrifugal Separation*, Churchill College, Cambridge, England
- WHITCAR MJ (1999): Carbon and hydrogen isotope systematics of bacterial formation and oxidation of methane. In: *Chem. Geol.* 161 (1-3), pp. 291–314
- WIEGLEB G (2016): *Gasmesstechnik in Theorie und Praxis*. Berlin: Springer. ISBN: 978-3-658-10686-7
- WILKINSON WL (1960): *Non-Newtonian fluids: Fluid mechanics, mixing and heat transfer*. London: Pergamon Press
- WILLNER D, DALY J, WHILEY D, GRIMWOOD K, WAINWRIGHT CE, HUGENHOLTZ P (2012): Comparison of DNA extraction methods for microbial community profiling with an application to pediatric bronchoalveolar lavage samples. In: *PLOS One*, Vol. 7, No. 4, pp. e34605
- WINTSCHE B, JEHLICH N, POPP D, HARMS H, KLEINSTEUBER S (2018): Metabolic Adaptation of Methanogens in Anaerobic Digesters Upon Trace Element Limitation. In: *Frontiers in Microbiology*, Vol. 9, pp. 405
- WILSON J D, SAWFORD B L (1996): Review of Lagrangian stochastic models for trajectories in the turbulent atmosphere. In: *Boundary-Layer Meteorology*, Vol. 78, No. 1, S. 191–210
- YARNES C (2013): $\delta^{13}\text{C}$ and $\delta^2\text{H}$ measurement of methane from ecological and geological sources by gas chromatography/combustion/pyrolysis isotope-ratio mass spectrometry. In: *Rapid Commun. Mass Spectrom.* 27, pp. 1036–1044
- YU Y, LEE C, KIM J, HWANG S (2005): Group-specific primer and probe sets to detect methanogenic communities using quantitative real-time polymerase chain reaction. In: *Biotechnology and Bioengineering*, Vol. 89, No. 6, pp. 670–679
- ZWIETERING M H, JONGENBURGER I, ROMBOUTS F M, VAN RIET K (1990): Modeling of the Bacterial Growth Curve. In: *Applied Environmental Microbiology*. Vol. 56, pp. 1875–1881



www.energetische-biomassenutzung.de

ISBN 978-3-946629-47-4

ISSN (online): 2698-9190

© 2020

Funding



Federal Ministry
for Economic Affairs
and Energy

Project management



Service & support



on the basis of a decision
by the German Bundestag